

Panel mounted receptacles with TwinCONTACT - Part no. 3070

- screwless spring terminals
- standard flange dimensions
- 20° inclination
- receptacles are designed for adding an auxiliary contact switch

Technical information

Ampere	16 A
Poles	5 p
Voltage	400V
Earth position	6 h
Hertz	50-60 Hz
Connection technology	Screwless - TwinCONTACT
Contact	standard
Protection type	IP 44

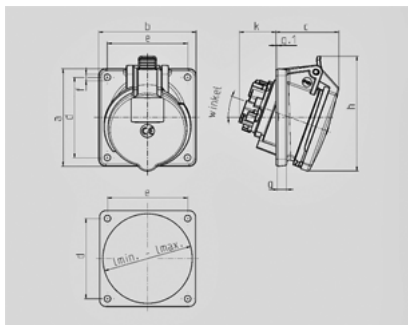

Drawing 1 MB 519	Amp. Poles	16			32		
		3	4	5	3	4	5
Dim. in mm							
a		85	85	85	85	85	85
b		85	85	85	85	85	85
c		52	57	55	61	60	66
d		70	70	70	70	70	70
e		70	70	70	70	70	70
f		5.5	5.5	5.5	5.5	5.5	5.5
g		8	8	8	8	8	8
g-1		2	2	2	2	2	2
h		86	96	100	96	104	110
k		31	32	33	43	44	48
l min.		57	64	70	78	78	78
l max.		76	76	76	78	78	78
ø		20	20	20	20	20	20
Terminal for cond. cross section (mm²) min.-max.		1.5	1.5	1.5	2.5	2.5	2.5
		-4	-4	-4	-10	-10	-10