

Panel mounted receptacles with TwinCONTACT - Part no. 3124

- screwless spring terminals
- standard flange dimensions
- 20° inclination
- receptacles are designed for adding an auxiliary contact switch

Technical information

Ampere	32 A
Poles	3 p
Voltage	110V
Earth position	4 h
Hertz	50-60 Hz
Connection technology	Screwless - TwinCONTACT
Contact	standard
Protection type	IP 44

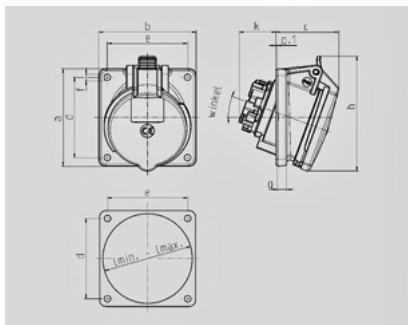

Drawing 1 MB 519	Amp. Poles	16			32		
		3	4	5	3	4	5
Dim. in mm	a	85	85	85	85	85	85
	b	85	85	85	85	85	85
	c	52	57	55	61	60	66
	d	70	70	70	70	70	70
	e	70	70	70	70	70	70
	f	5.5	5.5	5.5	5.5	5.5	5.5
	g	8	8	8	8	8	8
	g-1	2	2	2	2	2	2
	h	86	96	100	96	104	110
	k	31	32	33	43	44	48
	l min.	57	64	70	78	78	78
	l max.	76	76	76	78	78	78
	ø	20	20	20	20	20	20
Terminal for cond. cross section (mm ²) min.-max.		1.5	1.5	1.5	2.5	2.5	2.5
		-4	-4	-4	-10	-10	-10