

MITSUBISHI

PROFIBUS-DP

Master Module

User's Manual
(Hardware)

QJ71PB92V

Thank you for purchasing the Mitsubishi programmable controller MELSEC-Q series.

Prior to use, please read this and relevant manuals thoroughly to fully understand the product.

MELSEC-Q

Mitsubishi Programmable
Controller

MODEL	QJ71PB92V-U-HW
MODEL CODE	13JP82
IB(NA)-0800324-D(0808)MEE	

●SAFETY PRECAUTIONS●

(Always read these instructions before using this equipment.)

Before using this product, please read this manual and the relevant manuals introduced in this manual carefully and pay full attention to safety to handle the product correctly.

The instructions given in this manual are concerned with this product. For the safety instructions of the programmable controller system, please read the CPU module user's manual.

In this manual, the safety instructions are ranked as "DANGER" and "CAUTION".



DANGER

Indicates that incorrect handling may cause hazardous conditions, resulting in death or severe injury.



CAUTION

Indicates that incorrect handling may cause hazardous conditions, resulting in medium or slight personal injury or physical damage.

Note that the  **CAUTION** level may lead to a serious consequence according to the circumstances.

Always follow the instructions of both levels because they are important to personal safety.

Please save this manual to make it accessible when required and always forward it to the end user.

[Design Precautions]



- When a communication error occurs on PROFIBUS-DP, the status of the faulty station is as shown below.
Create an interlock circuit in the sequence program using the communication status information to ensure the system operates safely (Input X1, buffer memory 5A20_H to 5B19_H (23072 to 23321)).
An erroneous output or malfunction may cause accidents.
 - (1) The QJ71PB92V holds the input data before the communication failure.
 - (2) When the QJ71PB92V has gone down, the output status of each DP-Slave is dependent on the QJ71PB92V parameter setting on GX Configurator-DP.
 - (3) When a DP-Slave has gone down, the output status of the other DP-Slaves is dependent on the QJ71PB92V parameter setting on GX Configurator-DP.
- Do not output the "use prohibited" signal as the output signal to an intelligent function module from the programmable controller CPU.
Writing data into the "system area" or outputting a signal for "use prohibited" may cause system malfunction in the programmable controller.
- When a stop error has occurred to the CPU module, the communication status varies depending on the error time output mode setting of GX Developer as shown below.
Set the communication status for when a stop error has occurred to the CPU module according to the system specifications.
Note that, if the QJ71PB92V is mounted to a redundant system, it operates as described in (1) regardless of the setting.
 - (1) When "Error time output mode" is set to "Hold".
 - (a) Since the communication with the DP-Slave is continued, values at the time of the CPU module stop error occurrence are held as the output data sent to the DP-Slave from the QJ71PB92V.
 - (b) Input data received from DP-Slaves are updated into the buffer memory of the QJ71PB92V.
 - (2) When "Error time output mode" is set to "Clear".
 - (a) Communications with DP-Slaves are interrupted, and output data are not sent.
 - (b) Input data received from DP-Slaves are held in the buffer memory of the QJ71PB92V.

[Design Precautions]

DANGER

- When the QJ71PB92V is mounted in a redundant system, set the watchdog timer for DP-Slaves so that the calculation formula shown in PROFIBUS-DP Master Module User's Manual. If the formula is not satisfied, a watchdog timer error occurs in DP-Slaves during system switching.

CAUTION

- Do not bunch PROFIBUS cables with the main circuit or power wires, or install them close to each other.
They should be installed 100 mm (3.94 inch) or more from each other.
Not doing so could result in noise that would cause erroneous operation.

[Installation Precautions]

CAUTION

- Use the programmable controller under the environment specified in the user's manual of the CPU module to be used.
Using this programmable controller in an environment outside the range of the general specifications could result in electric shock, fire, erroneous operation, and damage to or deterioration of the product.
- While pressing the installation lever located at the bottom of module, insert the module fixing tab into the fixing hole in the base unit until it stops. Then, securely mount the module with the fixing hole as a supporting point.
Incorrect loading of the module can cause a malfunction, failure or drop.
When using the programmable controller in the environment of much vibration, tighten the module with a screw.
- Tighten the screw in the specified torque range.
Undertightening can cause a drop, short circuit or malfunction.
Overtightening can cause a drop, short circuit or malfunction due to damage to the screw or module.
- Completely turn off the externally supplied power used in the system before mounting or removing the module.
Not doing so could result in damage to the product.

[Installation Precautions]

CAUTION

- Do not directly touch the module's conductive parts or electronic components. Touching the conductive parts could cause an operation failure or give damage to the module.

[Wiring Precautions]

DANGER

- Be sure to shut off all phases of the external power supply used by the system before wiring PROFIBUS cables. Failure to do so may result in failure or malfunctions of the module.

CAUTION

- Be sure there are no foreign substances such as sawdust or wiring debris inside the module. Such debris could cause fires, damage, or erroneous operation.
- Be sure to place the PROFIBUS cables in a duct or clamp them. If not, dangling cables may be shifted or inadvertently pulled, resulting in damages to the module or cables or malfunctions due to poor cable contact.
- When disconnecting the PROFIBUS cable, do not pull it by holding the cable part. Be sure to hold its connector which is plugged into the module. Pulling the cable with it connected to the module may damage the module and/or cable, or cause malfunctions due to poor contact of the cable.
- The module has an ingress prevention label on its top to prevent foreign matter, such as wire offcuts, from entering the module during wiring. Do not peel this label during wiring. Before starting system operation, be sure to peel this label because of heat dissipation.

[Startup and Maintenance Precautions]

DANGER

- Before cleaning, be sure to shut off all phases of the external power supply used by the system.
Failure to do so may cause electrical shocks.

CAUTION

- Do not disassemble or modify the module.
Doing so could cause trouble, erroneous operation, injury, or fire.
- Use any radio communication device such as a cellular phone or a PHS phone more than 25cm (9.85 inch) away in all directions of the programmable controller.
Not doing so can cause a malfunction.
- Completely turn off the externally supplied power used in the system before mounting or removing the module.
Not doing so could result in damage to the product.
- Do not mount/remove the module to/from the base unit or terminal block more than 50 times (IEC 61131-2 compliant), after the first use of the product.
Failure to do so may cause module malfunctions.
- Before touching the module, always touch grounded metal, etc. to discharge static electricity from human body, etc.
Not doing so can cause the module to fail or malfunction.

[Disposal Precautions]

CAUTION

- When disposing of this product, treat it as an industrial waste.

Revisions

* The manual number is given on the bottom right of the cover.

Print Date	*Manual Number	Revision
Aug., 2005	IB(NA)-0800324-A	First edition
Jun., 2006	IB(NA)-0800324-B	<u>Modifications</u> SAFETY PRECAUTIONS, Chapter 2,4 <u>Additions</u> Chapter 6
May, 2007	IB(NA)-0800324-C	<u>Additions</u> SAFETY PRECAUTIONS, Manuals, Section 3.1, Chapter 4, 6
Aug., 2008	IB(NA)-0800324-D	<u>Additions</u> Compliance with the EMC and Low Voltage Directives, Section 3.1

This manual confers no industrial property rights or any rights of any other kind, nor does it confer any patent licenses. Mitsubishi Electric Corporation cannot be held responsible for any problems involving industrial property rights which may occur as a result of using the contents noted in this manual.

CONTENTS

1. Overview	1
2. Specification	2
3. Implementation and Installation	4
3.1 Handling precautions	4
3.2 Installation environment	5
4. Part Names and Settings	6
5. Wiring	9
5.1 PROFIBUS cable wiring	9
5.2 Wiring precautions	12
6. Setting from GX Developer	13
7. External Dimensions	14

About Manuals

The following manuals are related to this product.
Please purchase them if necessary.

Related Manuals

Manual name	Manual number. (Model code)
PROFIBUS-DP Master Module User's Manual Explains the overview, system configuration, specifications, functions, procedures before system operation, programming and dedicated instructions of QJ71PB92V.	SH-080572ENG (13JR84)
PROFIBUS-DP Interface Module User's Manual *1 Explains the overview of the QJ71PB92D-compatible function, system configurations, specifications, functions, procedures before system operation, programming, and dedicated instructions.	SH-080127 (13JR22)

*1 Refer to it when using the QJ71PB92D-compatible function.

Compliance with the EMC and Low Voltage Directives

(1) For programmable controller system

To configure a system meeting the requirements of the EMC and Low Voltage Directives when incorporating the Mitsubishi programmable controller (EMC and Low Voltage Directives compliant) into other machinery or equipment, refer to Chapter 9 "EMC AND LOW VOLTAGE DIRECTIVES" of the QCPU User's Manual (Hardware Design, Maintenance and Inspection).

The CE mark, indicating compliance with the EMC and Low Voltage Directives, is printed on the rating plate of the programmable controller.

(2) For the product

No additional measures are necessary for the compliance of this product with the EMC and Low Voltage Directives.

1. Overview

This manual is provided for handling the QJ71PB92V PROFIBUS-DP master module (hereinafter referred to as "QJ71PB92V").

First, open the package of the QJ71PB92V and check that the following is included.

Table 1.1 Packing List

Model	Product name	Quantity
QJ71PB92V	QJ71PB92V PROFIBUS-DP master module	1

2. Specification

The performance specifications of the QJ71PB92V are given below.
When using the QJ71PB92D-compatible function, refer to the PROFIBUS-DP Interface Module User's Manual.

For the general specifications of the QJ71PB92V, refer to the QCPU User's Manual (Hardware Design, Maintenance and Inspection).

Table 2.1 Performance specifications

Item		Specifications	
PROFIBUS-DP station type		DP-Master (Class 1)	
Transmission specifications	Electrical standard/ characteristics	EIA-RS485 compliant	
	Medium	Shielded twisted pair cable (Refer to Section 5.1.)	
	Network topology	Bus topology (Tree topology when repeaters are used)	
	Data link method	<ul style="list-style-type: none"> • Between DP-Master and DP-Master: Token passing method • Between DP-Master and DP-Slave: Polling method 	
	Encoding method	NRZ	
	Transmission speed *1	9.6 kbps to 12Mbps (Refer to (1) in this chapter.)	
	Transmission distance	Differs depending on the transmission speed (Refer to (1) in this chapter.)	
	Max. No. of repeaters	3 repeaters	
	Number of connectable modules (Per segment)	32 per segment (including repeater(s))	
	Number of connectable modules (Per network)	126 per network (total of DP-Masters and DP-Slaves)	
	Max. No. of DP-Slaves *2 (Per QJ71PB92V)	125 per QJ71PB92V	
Transmission specifications	I/O data size	Input data	Max. 8192 bytes (Max. 244 bytes per DP-Slave)
		Output data	Max. 8192 bytes (Max. 244 bytes per DP-Slave)
Number of writes to flash ROM		Max. 100000 times	
No. of occupied I/O points		32 (I/O assignment: 32 special points)	
Internal current consumption (5V DC)		0.57A	
External dimensions		98(3.86 in.)(H)×27.4(1.08 in.)(W)×90(3.54 in.)(D) [mm]	
Weight		0.13kg	

*1 The transmission speed is controlled within $\pm 0.2\%$. (Compliant with IEC 61158-2)

*2 Up to 124 when the QJ71PB92V is mounted to redundant system.

(1) Transmission distance

Table 2.2 Transmission distance

Transmission speed	Transmission distance	Max. Transmission distance when repeater is used *1
9.6kbps	1200m(3937ft.)/segment	4800m(15748ft.)/network
19.2kbps		
93.75kbps		
187.5kbps	1000m(3281ft.)/segment	4000m(13123ft.)/network
500kbps	400m(1312ft.)/segment	1600m(5249ft.)/network
1.5Mbps	200m(656ft.)/segment	800m(2625ft.)/network
3Mbps	100m(328ft.)/segment	400m(1312ft.)/network
6Mbps		
12Mbps		

*1 The max. transmission distance in the table above is based on the case where 3 repeaters are used.

The calculation formula for the transmission distance extended using a repeater(s) is:

Max. transmission distance [m/network] = (No. of repeaters +1)×Transmission distance [m/segment]

3. Implementation and Installation

This section provides the handling precautions, from unpacking to installation of the QJ71PB92V.

For details on implementation and installation of the QJ71PB92V, refer to the "QCPU User's Manual (Hardware Design, Maintenance and Inspection)."

3.1 Handling precautions

The following are precautions for handling the QJ71PB92V as a unit.

- (1) Do not drop the module case or subject it to heavy impact since it is made of resin.
- (2) Do not remove the printed-circuit board of each from its case.
This may cause a failure in the module.
- (3) Be careful not to let foreign objects such as wire burrs enter the module during wiring.
In the even any foreign object enters, remove it immediately.
- (4) The module has an ingress prevention label on its top to prevent foreign matter, such as wire offcuts, from entering the module during wiring.
Do not peel this label during wiring.
Before starting system operation, be sure to peel this label because of heat dissipation.
- (5) Before touching the module, always touch grounded metal, etc. to discharge static electricity from human body, etc.
Not doing so can cause the module to fail or malfunction.
- (6) Tighten the screws such as module fixing screws within the following ranges.

Table 3.1 Screw tightening torque

Screw location	Tightening torque range
Module fixing screw (M3 screw) *1	0.36 to 0.48N•m
PROFIBUS cable connector screw (#4-40 UNC screws)	0.20 to 0.28N•m

*1 The module can be easily fixed onto the base unit using the hook at the top of the module.

However, it is recommended to secure the module with the module fixing screw if the module is subject to significant vibration.

3.2 Installation environment

Refer to the QCPU User's Manual (Hardware Design, Maintenance and Inspection).

4. Part Names and Settings

This section explains the names and settings of each part of the QJ71PB92V.

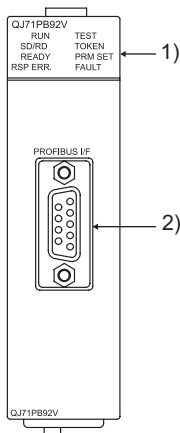

Figure 4.1 QJ71PB92V appearance

Table 4.1 Names of part

No.	Name	Description
1)	Indicator LEDs	These LEDs indicate the operation status of the QJ71PB92V. For details, refer to (1) in this chapter.
2)	PROFIBUS interface connector	This connector connects the PROFIBUS cable to the QJ71PB92V.*1

*1 Use a D-Sub 9-pin male connector.

The PROFIBUS cable is to be fabricated by users. (For details on cable wiring, refer to Section 5.1.)

The applicable screw size is #4-40 UNC.

(1) Indicator LEDs



Figure 4.2 Indicator LEDs

Table 4.2 Indicator LEDs

LED	Status	Description
RUN	ON	Normally operating
	OFF	Hardware error (watchdog timer error) or power failure
SD/RD	ON	Exchanging I/O data*1 or during acyclic communications *2
	Flashing	
	OFF	Not communicating with DP-Slave, or being in the standby system
READY	ON	Ready to communicate or communication being performed
	OFF	Not ready to communicate or no communication
RSP ERR.	ON	A communication error has occurred.
	OFF	No communication error
TEST	ON	Executing self-diagnostics or flash ROM initialization
	Flashing	Executing self-diagnostics
	OFF	Not executing self-diagnostics or flash ROM initialization
TOKEN	ON	Token being passed*3
	Flashing	
	OFF	No token passing, or being in the standby system*3
PRM SET	ON	Operating in parameter setting mode (mode 1)
	Flashing	The written parameters are invalid
	OFF	Operating in operation mode other than parameter setting mode (mode 1)
FAULT	ON	An error has occurred
	OFF	Normally operating

(To the next page)

- *1 The LED flashes at intervals based on the value set in "Data control time" in Master Parameters.
- *2 The LED flashes at the time of request or response in acyclic communication.
- *3 The LED status during token passing varies depending on the number of DP-Masters within the same network and the transmission speed setting, as shown the Table 4.3.

Table 4.3 TOKEN LED status

No. of DP-Masters within the same network	Transmission speed	
	19.2kbps or less	93.75kbps or more
1	ON	
More than 1	Flashing	ON or OFF

5. Wiring

5.1 PROFIBUS cable wiring

The following describes the pin assignments of the PROFIBUS interface connector on the QJ71PB92V, the PROFIBUS cable wiring specifications, bus terminator and other information.

(1) Pin assignments of the PROFIBUS interface connector

The following shows the pin assignments of the PROFIBUS interface connector (D-sub 9-pin female connector).

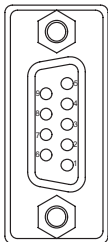

Figure 5.1 PROFIBUS interface connector

Table 5.1 Pin assignments of the PROFIBUS interface connector

Pin No.	Signal code	Name	Description	Cable color
1	—	SHIELD *1	Shield, protective ground	—
2	—	—	Open	—
3	B/B'	RxD/TxD-P	Receive/send data-P	Red
4	—	—	Open	—
5	C/C'	DGND *2	Data Ground	—
6	—	VP *2	Voltage +	—
7	—	—	Open	—
8	A/A'	RxD/TxD-N	Receive/send data-N	Green
9	—	—	Open	—

*1 Optional signal

*2 Signal used to connect the bus terminator

(2) PROFIBUS cable

The following shows the PROFIBUS cable and wiring specifications.

(a) PROFIBUS cable

Use a PROFIBUS cable that meets the following specifications (Type A (IEC 61158-2) compliant).

Table 5.2 PROFIBUS cable specifications

Item	Transmission line
Applicable cable	Shielded twisted pair cable
Impedance	135 to 165 Ω (f = 3 to 20MHz)
Capacity	Less than 30pF/m
Conductor resistance	Less than 110 Ω /km
Cross-sectional area	0.34mm ² or more (22AWG)

(b) Wiring specifications

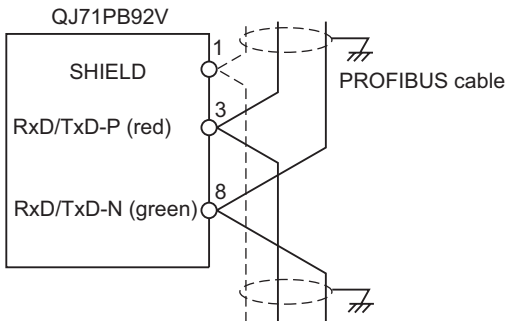

Figure 5.2 PROFIBUS cable wiring specifications

(3) Connector

Use a D-sub 9-pin male connector for the PROFIBUS cable. The applicable screw size is #4-40 UNC.

(4) Wiring specifications for bus terminator

When the QJ71PB92V is a terminal station, use a connector with built-in bus terminator that meets the following wiring specifications.

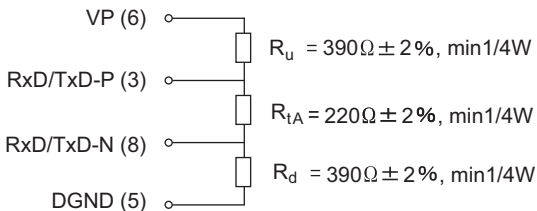

Figure 5.3 Wiring specifications for bus terminator

(5) PROFIBUS equipment

The PROFIBUS cables, connectors and other PROFIBUS equipment must be purchased or obtained at user's discretion. For details on PROFIBUS equipment, access the following website.

• PROFIBUS International : <http://www.profibus.com/>

5.2 Wiring precautions

As one of the requirements to give full play to QJ71PB92V's functions and make up the system with high reliability, it is necessary to have an external wiring unsusceptible to an influence of noise.

The following gives the precautions for external wiring of the QJ71PB92V.

(1) Communication cable wiring

Do not install the QJ71PB92V communication cable together with the main circuit, power lines and/or load carrying wires for other than the programmable controller, or bring them close.

Doing so may cause the QJ71PB92V to be affected by noise and surge induction.

(2) Wirings from programmable controller and I/O modules

Keep the PROFIBUS cable away from I/O module cables as much as possible.

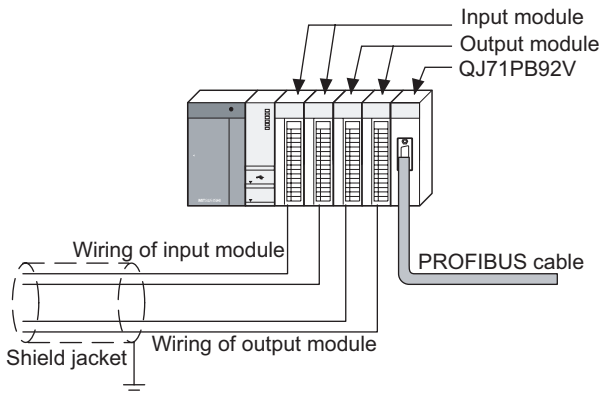
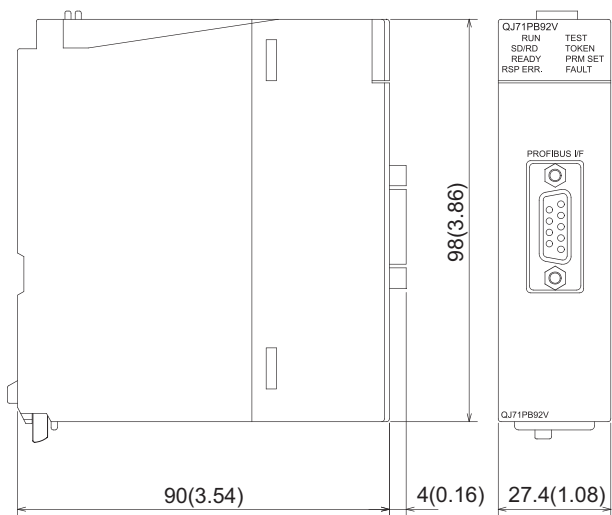

Figure 5.4 Programmable controller wiring

(3) Grounding

For use of the QJ71PB92V, ground the FG and LG terminals of the programmable controller's power supply module.

7. External Dimensions



Unit : mm(inch)

Figure 7.1 External dimensions

Company names and product names used in this document are trademarks or registered trademarks of respective owners.

Warranty

Mitsubishi will not be held liable for damage caused by factors found not to be the cause of Mitsubishi; machine damage or lost profits caused by faults in the Mitsubishi products; damage, secondary damage, accident compensation caused by special factors unpredictable by Mitsubishi; damages to products other than Mitsubishi products; and to other duties.

For safe use

- This product has been manufactured as a general-purpose part for general industries, and has not been designed or manufactured to be incorporated in a device or system used in purposes related to human life.
- Before using the product for special purposes such as nuclear power, electric power, aerospace, medicine or passenger movement vehicles, consult with Mitsubishi.
- This product has been manufactured under strict quality control. However, when installing the product where major accidents or losses could occur if the product fails, install appropriate backup or failsafe functions in the system.

Country/Region	Sales office/Tel	Country/Region	Sales office/Tel
U.S.A	Mitsubishi Electric Automation Inc. 500 Corporate Woods Parkway Vernon Hills, IL 60061, U.S.A. Tel : +1-847-478-2100	Hong Kong	Mitsubishi Electric Automation (Hong Kong) Ltd. 10th Floor, Manulife Tower, 169 Electric Road, North Point, Hong Kong Tel : +852-2887-8870
Brazil	MELCO-TEC Rep. Com.e Assessoria Tecnica Ltda. Rua Correia Dias, 184, Edificio Paraiso Trade Center-8 andar Paraiso, Sao Paulo, SP Brazil Tel : +55-11-5908-8331	China	Mitsubishi Electric Automation (Shanghai) Ltd. 4/F Zhi Fu Plaza, No.80 Xin Chang Road, Shanghai 200003, China Tel : +86-21-6120-0808
Germany	Mitsubishi Electric Europe B.V. German Branch Gothaer Strasse 8 D-40880 Ratingen, GERMANY Tel : +49-2102-486-0	Taiwan	Setsubo Enterprise Co., Ltd. 6F No.105 Wu-Kung 3rd.Rd, Wu-Ku Hsiang, Taipei Hsine, Taiwan Tel : +886-2-2299-2499
U.K	Mitsubishi Electric Europe B.V. UK Branch Travellers Lane, Hatfield, Hertfordshire., AL10 8XB, U.K. Tel : +44-1707-276100	Korea	Mitsubishi Electric Automation Korea Co., Ltd. 1480-6, Gayang-dong, Gangseo-ku Seoul 157-200, Korea Tel : +82-2-3660-9552
Italy	Mitsubishi Electric Europe B.V. Italian Branch Centro Dir. Colleoni, Pal. Perseo-Ingr.2 Via Paracelso 12, I-20041 Agrate Brianza., Milano, Italy Tel : +39-039-60531	Singapore	Mitsubishi Electric Asia Pte, Ltd. 307 Alexandra Road #05-01/02, Mitsubishi Electric Building, Singapore 159943 Tel : +65-6470-2460
Spain	Mitsubishi Electric Europe B.V. Spanish Branch Carretera de Rubi 76-80, E-08190 Sant Cugat del Valles, Barcelona, Spain Tel : +34-93-565-3131	Thailand	Mitsubishi Electric Automation (Thailand) Co., Ltd. Bang-Chan Industrial Estate No.111 Moo 4, Serithai Rd, T.Kannayao, A.Kannayao, Bangkok 10230 Thailand Tel : +66-2-517-1326
France	Mitsubishi Electric Europe B.V. French Branch 25, Boulevard des Bouvets, F-92741 Nanterre Cedex, France TEL: +33-1-5568-5568	Indonesia	P.T. Autoteknindo Sumber Makmur Muara Karang Selatan, Block A/Utara No.1 Kav. No.11 Kawasan Industri Pergudangan Jakarta - Utara 14440, P.O.Box 5045 Jakarta, 11050 Indonesia Tel : +62-21-6630833
South Africa	Circuit Breaker Industries Ltd. Private Bag 2016, ZA-1600 Isando, South Africa Tel : +27-11-928-2000	India	Messung Systems Pvt. Ltd. Electronic Sadan NO:III Unit No15, M.I.D.C Bhosari, Pune-411026, India Tel : +91-20-2712-3130
		Australia	Mitsubishi Electric Australia Pty. Ltd. 348 Victoria Road, Rydalmere, N.S.W 2116, Australia Tel : +61-2-9684-7777

MITSUBISHI ELECTRIC CORPORATION

HEAD OFFICE : TOKYO BUILDING, 2-7-3 MARUNOUCHI, CHIYODA-KU, TOKYO 100-8310, JAPAN
NAGOYA WORKS : 1-14, YADA-MINAMI 5-CHOME, HIGASHI-KU, NAGOYA, JAPAN

When exported from Japan, this manual does not require application to the Ministry of Economy, Trade and Industry for service transaction permission.

Specifications subject to change without notice.
Printed in Japan on recycled paper.