

# mitsubishi

---

## Model AJ71DN91/A1SJ71DN91 DeviceNet Master Module

---

### User's Manual (Hardware)

Thank you for buying the Mitsubishi general-purpose programmable logic controller MELSEC-A Series

Prior to use, please read both this manual and detailed manual thoroughly and familiarize yourself with the product.

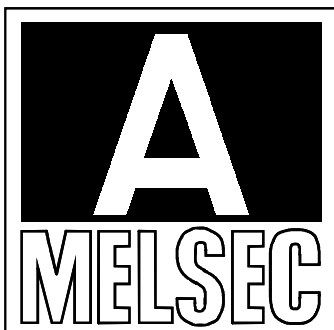

MODEL	AJ71DN91-U-H-E
MODEL CODE	13JL68
IB (NA)-66867-C(0407) MEE	

# ● SAFETY PRECAUTIONS ●

(Always read before starting use)

Before using this product, read this manual and the relevant manuals introduced in this manual carefully and handle the product correctly with full attention to safety.

The instructions given this manual are concerned with this product. Refer to the User's Manual of the CPU module in use for details on the safety instructions for the programmable logic controller system.

In this manual, the safety instructions are ranked as "DANGER" and "CAUTION".



Indicates that incorrect handling may cause hazardous conditions, resulting in death or severe injury.



Indicates that incorrect handling may cause hazardous conditions, resulting in minor or moderate injury or property damage.

Depending on circumstances, procedures indicated by  **CAUTION** may also be linked to serious results.

In any case, it is important to follow the directions for usage.

Store this manual in a safe place so that you can take it out and read it whenever necessary. Always forward it to the end user.

## [DESIGN PRECAUTIONS]

### DANGER

- If a communications error occurs to a DeviceNetwork, the station in such a communications error will be in a state as follows:
  - (1) The master station (AJ71DN91, A1SJ71DN91) maintains input data which had been received from the slave station before the error occurred.
  - (2) Whether or not the output signal of the slave station to be turned off or maintained is determined by the specification of the slave station or by the parameter settings in the master station.By referring to communications states of the slave station, arrange an interlock circuit in a sequential program and provide safety mechanism externally of the slave station in order the system to operate safely.

### CAUTION

- Do not bundle the control wires and communication cables with the main circuit or power wires, or install them close to each other. They should be installed at least 100 mm (3.94 in.) away from each other. Failure to do so may generate noise that may cause malfunctions.

## [INSTALLATION PRECAUTIONS]

### CAUTION

- Use the PLC in the operating environment that meets the general specifications given in the user's manual of the CPU module.  
Using the PLC in any other operating environment may cause an electric shock, fire or malfunction, or may damage or degrade the product.
- While pressing the installation lever located at the bottom of module, insert the module fixing tab into the fixing hole in the base unit until it stops.  
Then, securely mount the module with the fixing hole as a supporting point.  
If the module is not installed properly, it may cause the module to malfunction, fail or fall off.  
Secure the module with screws especially when it is used in an environment where constant vibrations or strong impact may be expected.  
Be sure to tighten the screws using the specified torque. If the screws are loose, it may cause the module to malfunction or fall off. If the screws are tightened excessively, it may damage the screws and/or the module, and cause the module to malfunction or fall off.
- Before mounting or dismounting the module, make sure to shut off all phases of the external power supply. Failure to do so may damage the product.
- Do not directly touch the conducting parts and electronic parts of the module. This may cause the module to malfunction or fail.

## [WIRING PRECAUTIONS]

### **DANGER**

- Make sure to shut off all the phases of the external power supply before starting installation or wiring. Otherwise, the personnel may be subjected to an electric shock or the product to a damage.

### **CAUTION**

- Always ground the FG terminal for the PLC.  
There is a risk of malfunction.
- Tighten the terminal screws with the specified torque. If the terminal screws are loose, it could result in short circuits or erroneous operation. Tightening the terminal screws too far may cause damages to the screws or the module, resulting in fallout, short circuits, or malfunction.
- Make sure that foreign materials such as chips or wire pieces may not be caught inside the module. They could cause a fire, a malfunction, or an operation error.
- Make sure to place the communications and power supply cables connected to the module within a duct or clamp them. Unless the cables are placed within a duct or clamped, the module or cables could be broken by swinging or moving of the cables or unintentional pulling to cause an operation error resulting from a contact error.
- Do not pull cables by holding them with a hand for removing the communications or power supply cables that are connected to the module. To remove a cable having a connector, hold the connector connected to the module with a hand. To remove a cable not having a connector, loosen the screws fastening to connect the module. The cables being pulled while they are still connected to the module could break the module or cables, or cause an operation error resulting from a contact error.

## [SETUP AND MAINTENANCE PRECAUTIONS ]

### CAUTION

- Do not touch the terminals while the power is on. Doing so may cause malfunctions.
- Make sure to shut off all the phases of the power supply before starting to clean the module or retighten the terminal screws. Otherwise, an operation error could occur.  
If the screws are loose, it may cause the module to short-circuit, malfunction or fall off. If the screws are tightened excessively, it may damage the screws and cause the module to short circuit, malfunction or fall off.
- Do not disassemble or modify the module. Disassembling or modifying the module could cause a failure, an operation error, an injury, or a fire.
- Make sure to shut off all the phases of the power supply externally before installing or removing the module. Otherwise, the module could cause a failure or an operation error.
- Before handling the module, always touch grounded metal, etc. to discharge static electricity from the human body.  
Failure to do so can cause the module to fail or malfunction.

## [DISPOSAL PRECAUTIONS]

### CAUTION

- To dispose of this product, treat it as an industrial waste.

## About the Manuals

The following product are available for this equipment.  
Refer to the table given below to choose suitable manuals.

### Detailed Manual

Manual name	Manual No. (Model code)
Model AJ71DN91/A1SJ71DN91 DeviceNet Master Module User's Manual	SH-4004 (13JL69)

# 1. Introduction

This manual describes the specifications and part names of Model AJ71DN91/A1SJ71DN91 DeviceNet Master Module (referred to as AJ71DN91, A1SJ71DN91, or DN91, hereafter) which is used in combination with MELSEC-A/QnA Series PLC CPU.

DN91 controls DeviceNet devices as the master station for DeviceNet. For specifications of DeviceNet, see DeviceNet Specifications (Release 2.0) Volumes 1 and 2.

DeviceNet is a registered trademark of Open DeviceNet Vendor Association, Inc.

## 2. System Configuration

The table below lists installable PLC CPUs, applicable data link systems/network systems, and the number of CPUs, with regard to DN91.

Installation location		Number of installable CPUs			
		A1SJ71DN91	AJ71DN91		
PLC CPU	A0J2CPU	Not applicable	No limitations		
	A0J2HCPU				
	A1SCPU(S1)	No limitations			
	A1SHCPU				
	A1SJCPU(S3)				
	A1SJHCPU				
	A1SCPUC24-R2				
	A2SCPU(S1)				
	A2SHCPU(S1)				
	A2USCPU(S1)				
	A2USHCPU-S1				
	A2ASCPU(S1/S30/S60)				
	Q2ASCPU(S1)				
	Q2ASHCPU(S1)				
	A1CPU			Not applicable	No limitations
	A2CPU(S1)				
	A3CPU				
	A1NCPU				
	A2NCPU(S1)				
	A3NCPU				
	A3MCPU				
	A3HCPU				
	A2ACPU(S1)				
	A3ACPU				
	A2UCPU(S1)				
	A3UCPU				
	A4UCPU				
Q2ACPU(S1)					
Q3ACPU					
Q4ACPU					
Q4ARCPU					
Data link and network	Remote I/O station of MELSECNET		Not applicable	Not applicable	
	Remote I/O station of MELSECNET/B				
	Remote I/O station of MELSECNET/10	AJ72LP25	Not applicable	No limitations	
		AJ72BR15			
AJ72QLP25					
AJ72QBR15					



## 3. Specifications

### 3.1 Performance specifications

The table below lists the performance specifications of DN91. The table below lists the performance specifications of DN91.

Item		Specifications						
Node type		Group 2 dedicated client						
Station numbers which can be set		0 to 63						
Number of connections which can be generated		63 connections for I/O communications 63 connections for message communications						
Communications data	Rate of communications	I/O communications	Transmitting	2048 points (256 bytes) *2				
			Receiving	2048 points (256 bytes) *2				
	Message communications	Transmitting	240 bytes					
		Receiving	240 bytes					
Communications speed		One speed can be selected from 125kbps, 250kbps, and 500kbps.						
Maximum cable length *1		Communications speed	Maximum transmitting distance of trunk line			Length of drop line		
			Thick Cables	Thick and Thin Cables	Thick and thin cables coexist	Maximum	Total	
			125 kbaud	500m	100m	See Section 3.1.1	6m	156 m
			250 kbaud	250m				78m
500 kbaud	100m	39m						
Number of input/output occupied points		Special 32 points						
Internal current consumption (5V DC)(A)		0.24						
Mass(kg)		A1SJ71DN91: 0.23, AJ71DN91: 0.43						

\*1: The maximum cable length complies with that in the DeviceNet specification (Release 2.0) Volumes 1 and 2.

\*2: Up to 255 bytes can be transferred per slave station.

#### 3.1.1 Maximum Transmitting Distance when Thick and Thin Cables Coexist

The table below lists both the maximum transmitting distance when thick and thin cables coexist.

Communications speed	Maximum transmitting distance of trunk line when thick and thin cables coexist
125kbaud	Thick cable length+5×Thin cable length≤500m
250kbaud	Thick cable length+2.5×Thin cable length≤250m
500kbaud	Thick cable length+Thin cable length≤100m

## 4. Part Names

### 4.1 Part Names

This section describes the part names of DN91.

AJ71DN91

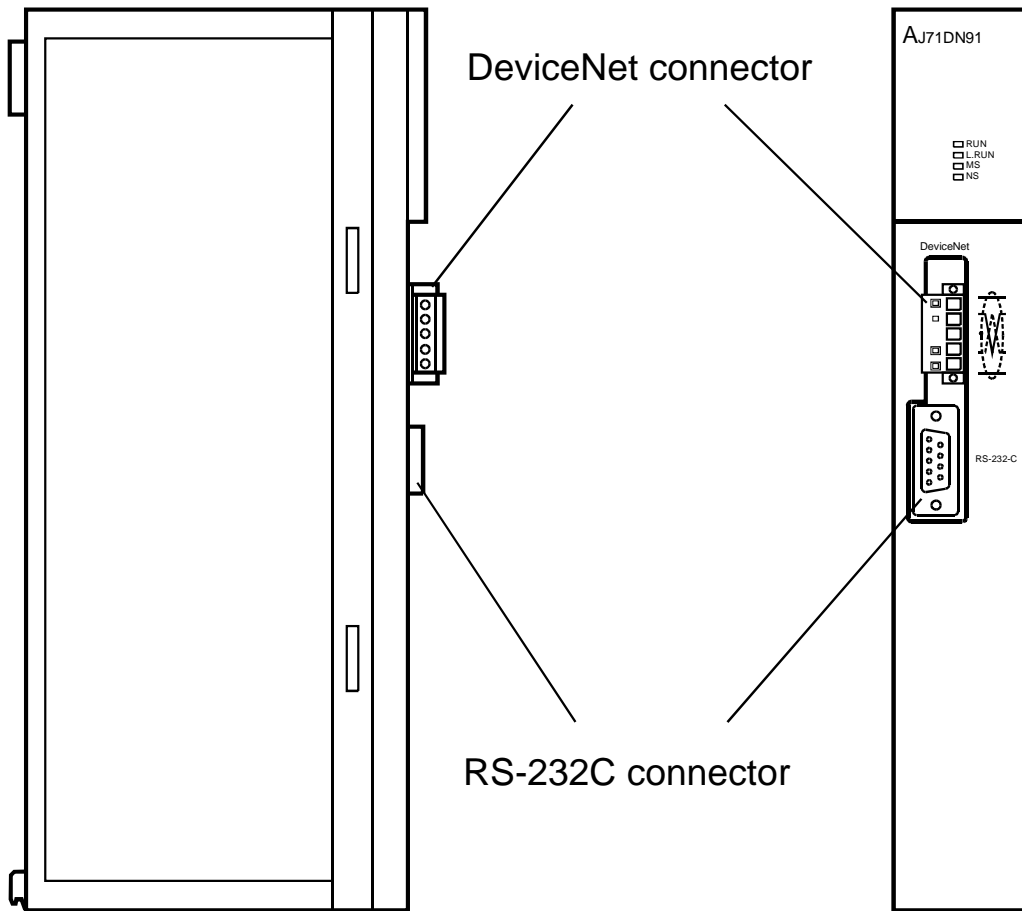

A1SJ71DN91

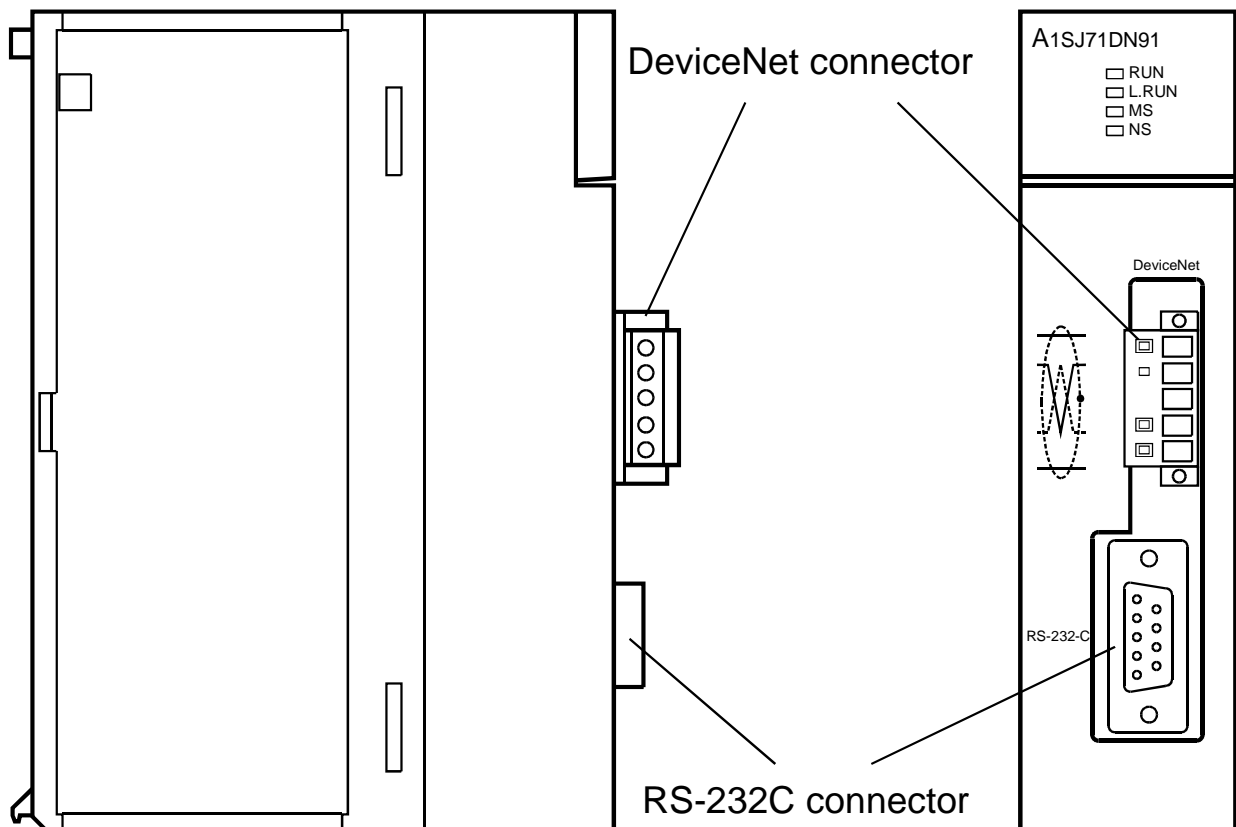

### 4.1.1 LED Display and Its Details

The table below explains LED display and its details.

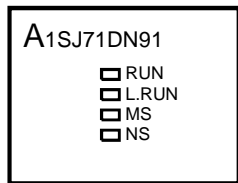
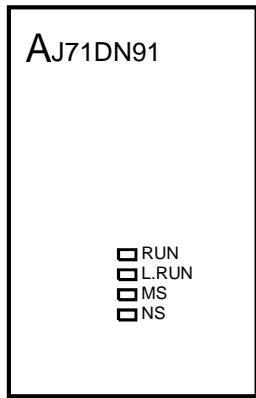

LED name	Color	Details	State of LED	
RUN	Red	Displaying normal operation	illuminating	In normal operation
			Not illuminating	Module error detected
				Power not supplied
			Flickering	Module error detected
Parameter being loaded				
L.RUN	Red	Displaying communications state	illuminating	In communications
			Not illuminating	Communications stopped
			Flickering (periodically)	Communications ready
			Flickering (random)	Communications parameter error
MS	Green (top)	Displaying module state	illuminating	DeviceNet interface in normal operation
			Flickering	Parameter error
	Red (bottom)	Displaying module state	Unused	
NS	Green (top)	Displaying network state	illuminating	In on-line state and communications possible with slave station
			Flickering	In on-line state but communications impossible with slave station
	Red (bottom)	Displaying network state	illuminating	Duplicated MAC ID error
				Bus off error occurred.

## 5. Handling Precautions

This section describes the cautions for handling the module.

- (1) Do not drop or give a hard physical shock to the enclosure and terminal block of the module as they are made of resin.
- (2) Do not remove the printed circuit board from the enclosure for the module. Removing it could cause a failure.
- (3) When wiring, make sure that no foreign materials such as wire pieces may be caught inside the module. Remove them if they are caught.
- (4) Apply a torque as specified in the table below for tightening fitting or terminal screws for the module.

Type of screw	Tightening torque range
A1SJ71DN91 Module mounting screw (M4)	78 to 118 N • cm
DeviceNet Connector screw	35.3 to 48.0 N • cm
DeviceNet Connector wire screw	60.8 to 82.3 N • cm

## 6. Wiring

This section describes the communications cable and RS-232C cable.

### 6.1 Wiring Communications Cable

The DeviceNet connector of DN91 is configured as illustrated below, where a seal corresponding to its cable color is adhered to the top surface of the connector.

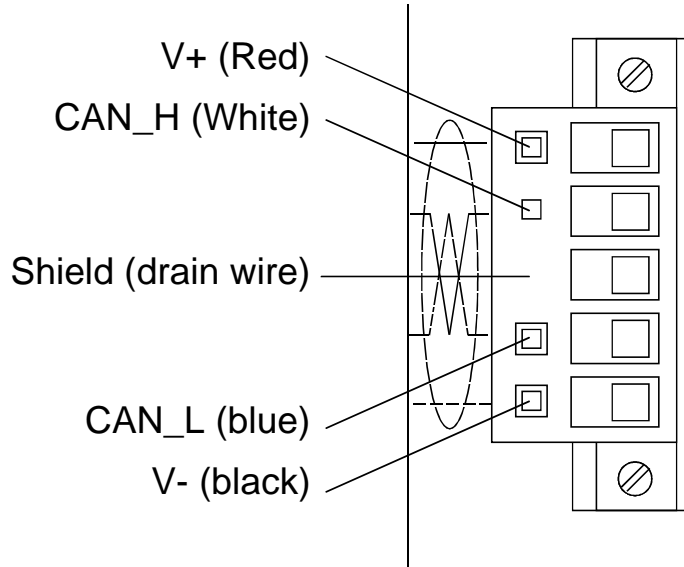

### 6.2 Wiring RS-232C Cable

The illustration below explains how to wire the RS-232C cable connecting DN91 with a PC/AT personal computer.

Dsub female  
connector for  
A(15)D530N15  
(9 pins)

Dsub female  
connector for PC/AT  
personal computer (9  
pins)

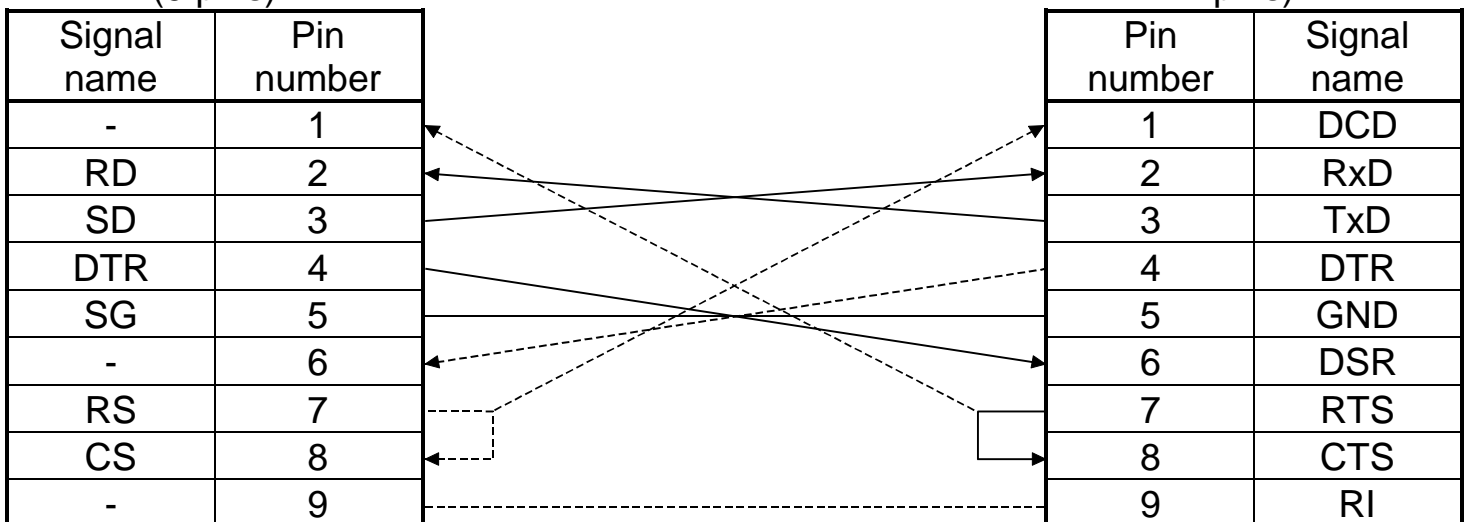

(1) Applying shielded cables are recommended.

(2) ----- indicates that no connection is needed but it is recommended to make a connection to eliminate specific orientation.

# 7. Outside Dimensions

(1) AJ71DN91

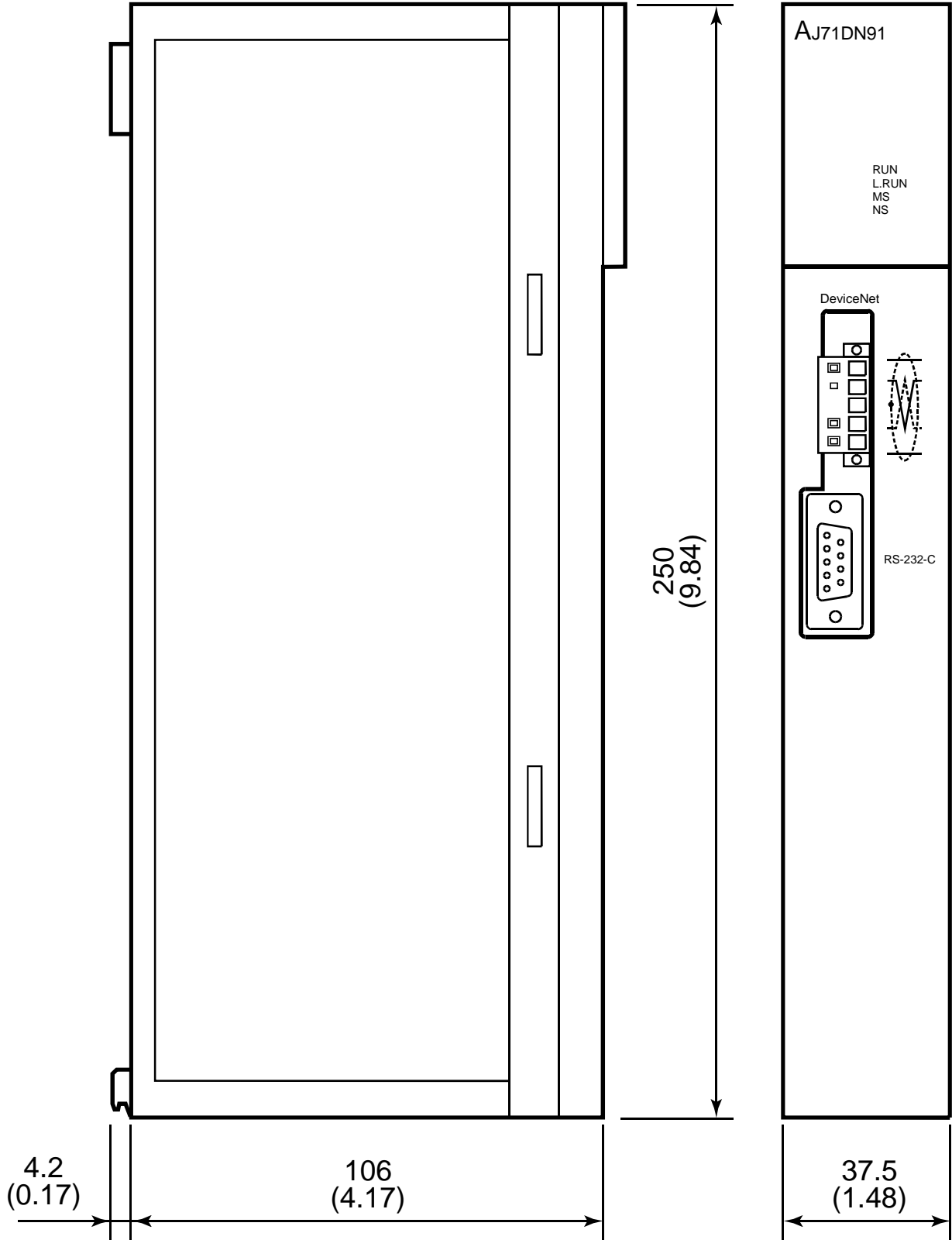

Unit: mm (inch)

(2) A1SJ71DN91

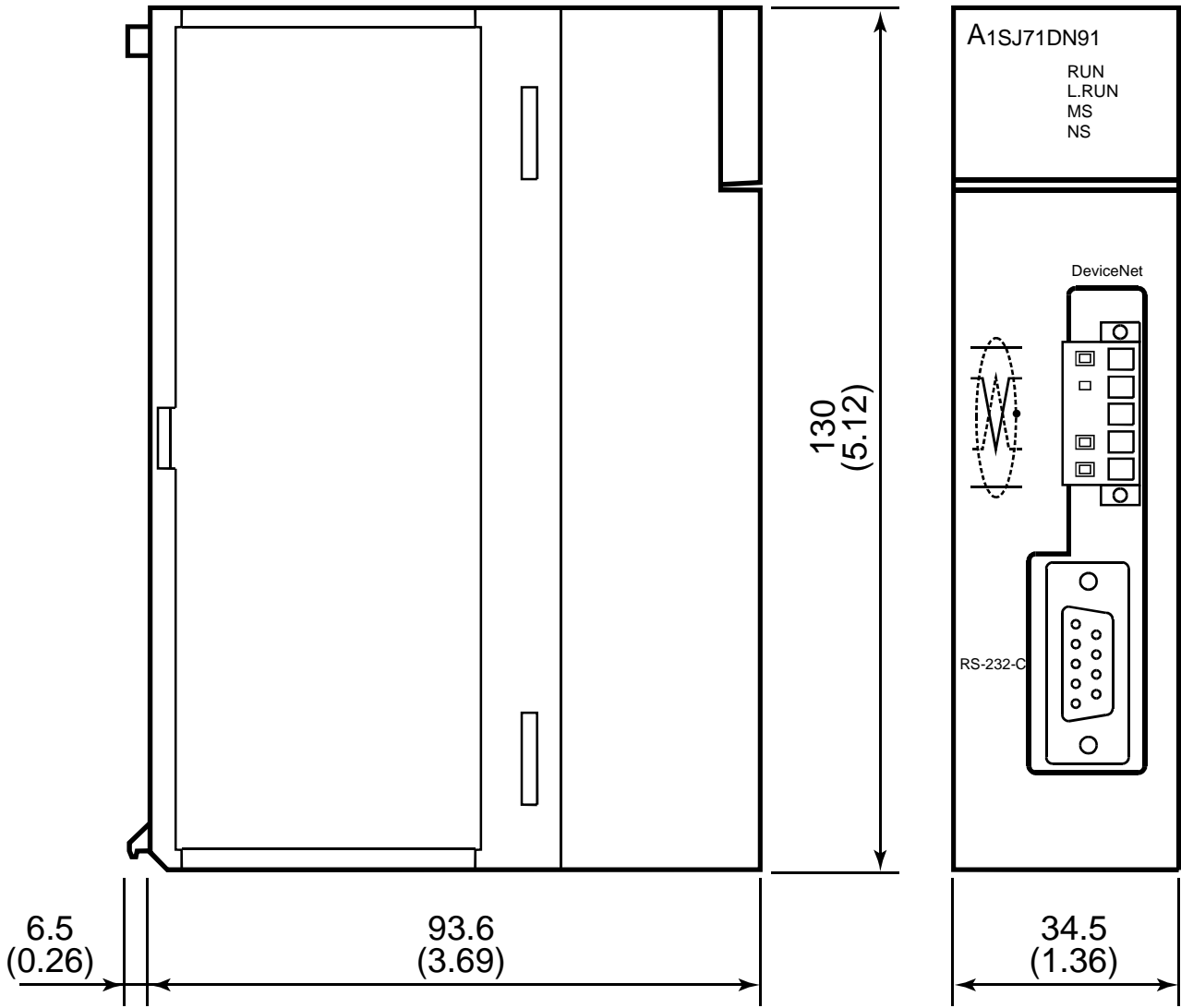

Unit : mm (inch)

## Warranty

Mitsubishi will not be held liable for damage caused by factors found not to be the cause of Mitsubishi; machine damage or lost profits caused by faults in the Mitsubishi products; damage, secondary damage, accident compensation caused by special factors unpredictable by Mitsubishi; damages to products other than Mitsubishi products; and to other duties.

### ⚠ For safe use

- This product has been manufactured as a general-purpose part for general industries, and has not been designed or manufactured to be incorporated in a device or system used in purposes related to human life.
- Before using the product for special purposes such as nuclear power, electric power, aerospace, medicine or passenger movement vehicles, consult with Mitsubishi.
- This product has been manufactured under strict quality control. However, when installing the product where major accidents or losses could occur if the product fails, install appropriate backup or failsafe functions in the system.

Country/Region	Sales office/Tel	Country/Region	Sales office/Tel
U.S.A	Mitsubishi Electric Automation Inc. 500 Corporate Woods Parkway Vernon Hills, IL 60061 Tel : +1-847-478-2100	Hong Kong	Ryoden Automation Ltd. 10th Floor, Manulife Tower, 169 Electric Road, North Point, HongKong Tel : +852-2887-8870
Brazil	MELCO-TEC Rep. Com.e Assessoria Tecnica Ltda. AV. Paulista 1471, Conj. 308, Sao Paulo City, Sao Paulo State, Brazil Tel : +55-11-283-2423	China	Ryoden Automation Shanghai Ltd. 3F Block5 Building Automation Instrumentation Plaza 103 Cao Bao Rd. Shanghai 200233 China Tel : +86-21-6475-3228
Germany	Mitsubishi Electric Europe B.V. German Branch Gothaer Strasse 8 D-40880 Ratingen, GERMANY Tel : +49-2102-486-0	Taiwan	Setsuyo Enterprise Co., Ltd. 6F., No.105 Wu-Kung 3rd.RD, Wu-Ku Hsiang, Taipei Hsine, Taiwan Tel : +886-2-2299-2499
U.K	Mitsubishi Electric Europe B.V. UK Branch Travellers Lane, Hatfield, Herts., AL10 8XB,UK Tel : +44-1707-276100	Korea	HAN NEUNG TECHNO CO.,LTD. 1F Dong Seo Game Channel Bldg., 660-11, Deungchon-dong Kangsec-ku, Seoul, Korea Tel : +82-2-3660-9552
Italy	Mitsubishi Electric Europe B.V. Italian Branch Centro Dir. Colleoni, Pal. Perseo-Ingr.2 Via Paracelso 12, 20041 Agrate B., Milano, Italy Tel : +39-039-6053344	Singapore	Mitsubishi Electric Asia Pte, Ltd. 307 ALEXANDRA ROAD #05-01/02, MITSUBISHI ELECTRIC BUILDING SINGAPORE 159943 Tel : +65-6473-2308
Spain	Mitsubishi Electric Europe B.V. Spanish Branch Carretera de Rubi 76-80 08190 - Sant Cugat del Valles, Barcelona, Spain Tel : +34-93-565-3131	Thailand	F. A. Tech Co.,Ltd. 898/28,29,30 S.V.City Building,Office Tower 2,Floor 17-18 Rama 3 Road, Bangkokpang, Yannawa, Bangkok 10120 Tel : +66-2-682-6522
France	Mitsubishi Electric Europe B.V. French Branch 25 Boulevard des Bouvets, F-92741 Nanterre Cedex, France TEL: +33-1-5568-5568	Indonesia	P.T. Autoteknindo SUMBER MAKMUR Jl. Muara Karang Selatan Block A Utara No.1 Kav. No.11 Kawasan Industri/ Pergudangan Jakarta - Utara 14440 Tel : +62-21-663-0833
South Africa	Circuit Breaker Industries LTD. Tripswitch Drive, Elandsfontein Gauteng, South Africa Tel : +27-11-928-2000	India	Messung Systems Put,Ltd. Electronic Sadan NO:111 Unit No15, M.I.D.C BHOSARI,PUNE-411026 Tel : +91-20-712-2807
		Australia	Mitsubishi Electric Australia Pty. Ltd. 348 Victoria Road, PostalBag, No 2, Rydalmere, N.S.W 2116, Australia Tel : +61-2-9684-7777

## MITSUBISHI ELECTRIC CORPORATION

HEAD OFFICE : 1-8-12, OFFICE TOWER Z 14F HARUMI CHUO-KU 104-6212, JAPAN  
NAGOYA WORKS : 1-14, YADA-MINAMI 5-CHOME, HIGASHI-KU, NAGOYA, JAPAN

When exported from Japan, this manual does not require application to the Ministry of Economy, Trade and Industry for service transaction permission.

Specifications subject to change without notice.  
Printed in Japan on recycled paper.