

Thermocouple Input Module
Channel Isolated Thermocouple/Micro Voltage Input Module

User's Manual

mitsubishi

Q series
Q series

Mitsubishi
Programmable Controller

MELSEC-Q

Q64TD

Q64TDV-GH

GX Configurator-TI
(SW1D5C-QTIU-E)

• SAFETY PRECAUTIONS •

(Always read these instructions before using this equipment.)

Before using this product, please read this manual and the relevant manuals introduced in this manual carefully and pay full attention to safety to handle the product correctly.

The instructions given in this manual are concerned with this product. For the safety instructions of the programmable controller system, please read the user's manual for the CPU module to use.

In this manual, the safety instructions are ranked as "DANGER" and "CAUTION".



Indicates that incorrect handling may cause hazardous conditions, resulting in death or severe injury.



Indicates that incorrect handling may cause hazardous conditions, resulting in medium or slight personal injury or physical damage.

Note that the  CAUTION level may lead to a serious consequence according to the circumstances. Always follow the instructions of both levels because they are important to personal safety.

Please store this manual in a safe place and make it accessible when required. Always forward it to the end user.

[DESIGN PRECAUTION]

DANGER

- Do not write data into the "system area" of the buffer memory of intelligent function modules. Also, do not use any "prohibited to use" signals as an output signal to an intelligent function module from the CPU.
Writing data into the "system area" or outputting a signal for "prohibited to use" may cause a programmable controller system malfunction.

CAUTION

- Do not bunch the control wires or communication cables with the main circuit or power wires, or install them close to each other.
They should be installed 100mm(3.94inch) or more from each other.
Not doing so could result in noise that may cause malfunction.

[INSTALLATION PRECAUTIONS]

CAUTION

- Use the programmable controller in an environment that meets the general specifications contained in the user's manual of the CPU module to use.
Using this programmable controller in an environment outside the range of the general specifications may cause electric shock, fire, malfunction, and damage to or deterioration of the product.
- While pressing the installation lever located at the bottom of module, insert the module fixing tab into the fixing hole in the base unit until it stops. Then, securely mount the module with the fixing hole as a supporting point.
Improper installation may result in malfunction, breakdown or the module coming loose and dropping.
Securely fix the module with screws if it is subject to vibration during use.
- Tighten the screws within the range of specified torque.
If the screws are loose, it may cause the module to fallout, short circuits, or malfunction.
If the screws are tightened too much, it may cause damage to the screw and/or the module, resulting in fallout, short circuits or malfunction.
- Be sure to shut off all phases of the external power supply used by the system before mounting or removing the module.
Not doing so may cause damage to the module.
In the system where a CPU module supporting the online module change is used and on the MELSECNET/H remote I/O stations, modules can be replaced online (during energizing). However, there are some restrictions on replaceable modules and the replacement procedures are predetermined for each module.
For details, refer to the chapter of the online module change in this manual.
- Do not directly touch the conductive area or electronic components of the module.
Doing so may cause malfunction or failure in the module.

[WIRING PRECAUTIONS]

CAUTION

- Always ground the FG terminal for the programmable controller. There is a risk of electric shock or malfunction.
- When turning on the power and operating the module after wiring is completed, always attach the terminal cover that comes with the product.
There is a risk of electric shock if the terminal cover is not attached.
- Tighten the terminal screws within the range of specified torque.
If the terminal screws are loose, it may result in short circuits or malfunction.
If the terminal screws are tightened too much, it may cause damage to the screw and/or the module, resulting in short circuits or malfunction.
- Be careful not to let foreign matter such as sawdust or wire chips get inside the module.
They may cause fires, failure or malfunction.
- The top surface of the module is covered with protective film to prevent foreign objects such as cable offcuts from entering the module when wiring.
Do not remove this film until the wiring is complete.
Before operating the system, be sure to remove the film to provide adequate ventilation.
- Use applicable solderless terminals and tighten them with the specified torque.
If any solderless spade terminal is used, it may be disconnected when the terminal screw comes loose, resulting in failure.
- Always place the thermocouple at least 100mm(3.94inch) away from the main circuit cables and AC control lines. Fully keep it away from high-voltage cables and circuits which include harmonics, such as an inverter's load circuit.
Not doing so will make the module more susceptible to noises, surges and inductions.

[STARTING AND MAINTENANCE PRECAUTIONS]

CAUTION

- Do not disassemble or modify the modules.
Doing so could cause failure, malfunction injury or fire.
- Be sure to shut off all phases of the external power supply used by the system before mounting or removing the module.
Not doing so may cause damage to the module.
In the system where a CPU module supporting the online module change is used and on the MELSECNET/H remote I/O stations, modules can be replaced online (during energizing).
However, there are some restrictions on replaceable modules and the replacement procedures are predetermined for each module.
For details, refer to the chapter of the online module change in this manual.
- Do not install/remove the module to/from the base unit, or the terminal block to/from the module more than 50 times after the first use of the product. (IEC 61131-2 compliant)
Failure to do so may cause malfunction.
- Do not touch the connector while the power is on.
Doing so may cause malfunction.
- Switch off all phases of the externally supplied power used in the system when cleaning the module or retightening the terminal or module fixing screws.
Not doing so may cause failure or malfunction of the module.
If the screws are loose, it may cause the module to fallout, short circuits, or malfunction.
If the screws are tightened too much, it may cause damages to the screws and/or the module, resulting in the module falling out, short circuits or malfunction.
- Always make sure to touch the grounded metal to discharge the electricity charged in the body, etc., before touching the module.
Failure to do so may cause a failure or malfunctions of the module.

[DISPOSAL PRECAUTIONS]

CAUTION

- When disposing of this product, treat it as industrial waste.

REVISIONS

* The manual number is given on the bottom left of the back cover.

Print Date	* Manual Number	Revision
Nov., 2000	SH (NA)-080141-A	First printing
Jun., 2001	SH (NA)-080141-B	<p>Addition Selection 2.1, 2.2</p> <p>Correction Conformation to the EMC Directive and Low Voltage Instruction, About the Generic Terms and Abbreviations, Product Structure, Section 3.1.1, Section 5.2, 5.2.1, 5.2.2, 5.3.3</p>
Feb., 2002	SH (NA)-080141-C	<p>Q64TDV-GH was added as a new model.</p> <p>Addition Section 3.1.2, 3.2.1, 3.2.3, 3.4.2, 3.4.10, 3.4.11, 3.4.20, 3.4.21, Section 5.6.3, Chapter 7, Section 8.2.8, Appendix 4 to 6</p> <p>Correction SAFETY PRECAUTIONS, About the Generic Terms and Abbreviations, Chapter 1, Section 1.1, Section 2.1, 2.2, Section 3.1.1, 3.2, 3.2.2, 3.3.1, 3.3.2, 3.4.1, 3.4.3 to 3.4.9, 3.4.13 to 3.4.16, 3.4.18, 3.4.19, Section 4.2, 4.3, 4.4.1, 4.4.2, 4.5 to 4.7, Section 5.1, 5.2.1, 5.2.2, 5.4, 5.5, 5.6.1, 5.6.2, Chapter 6, Chapter 8, Section 8.1, 8.2.1, 8.2.5 to 8.2.7, 8.2.9, Appendix 7</p>
Feb., 2003	SH (NA)-080141-D	<p>Addition Section 1.2, Section 5.6.4</p> <p>Correction SAFETY PRECAUTIONS, Section 2.1, Section 3.1.1, 3.1.2, 3.2, 3.3.1, 3.3.2, 3.4.1, 3.4.2, 3.4.4, 3.4.7, 3.4.8, 3.4.13 to 3.4.19, 3.4.21, Section 4.3, 4.5, 4.6, Section 5.1, 5.2.1, 5.2.2, 5.3.2, 5.3.3, 5.4, 5.5, 5.6.1 to 5.6.3, Section 6.1, 6.1.1, 6.1.2, 6.2, 6.2.1, 6.2.2, 7.3.1, 7.3.3, 7.3.4, 7.3.6, 7.4, Section 8.1, 8.2.1, 8.2.5, Appendix 4.1, Appendix 5.2, Appendix 5.3</p>
Sep., 2003	SH (NA)-080141-E	<p>Addition Section 3.4.1, 3.4.2, 3.4.21, Section 4.5, 4.6</p> <p>Correction Section 3.1.1, 3.1.2, 3.3.1, 3.3.2, 3.4.1 to 3.4.21, Section 4.5, 4.6, Section 5.1, 5.2.1, 5.3.1, 5.3.2, 5.5, 5.6.1 to 5.6.4, Section 6.1.1, 6.2.1, Chapter 7, Section 7.3.4, 7.3.6, 7.4, Appendix 5.2, Appendix 5.3, Appendix 7</p>
May, 2004	SH (NA)-080141-F	<p>Correction Section 2.2, Section 3.4.14, Section 7.1, 7.3.1 to 7.3.6</p>
Oct., 2004	SH (NA)-080141-G	<p>Correction SAFETY PRECAUTIONS, Section 2.1, Section 3.1.1, Section 4.1, Section 6.2, 6.2.1</p>

Print Date	* Manual Number	Revision
Sep., 2005	SH(NA)-080141-H	<p>Addition Section 3.2.4, 3.4.20, 3.4.21, Appendix 4.2</p> <p>Correction Conformation to the EMC Directive and Low Voltage Instruction, Section 1.2, Section 2.1, 2.2, Section 3.1.1, 3.1.2, 3.2, 3.2.3, 3.3.1, 3.3.2, 3.4.1, 3.4.2, 3.4.6, 3.4.14, 3.4.19, Section 5.1, 5.2.2, Section 6.1.1, 6.2.1, 6.2.2, Section 8.2.9, Appendix 4.1</p>
Feb., 2006	SH(NA)-080141-I	<p>Addition Appendix 5.1</p> <p>Correction SAFETY PRECAUTIONS, Section 1.2, Section 2.2, Section 3.4.14, Section 7.3.3, 7.3.5, Appendix 5, INDEX</p> <p>Section number changed Appendix 5.1 → Appendix 5.2, Appendix 5.2 → Appendix 5.3, Appendix 5.3 → Appendix 5.4</p>
Mar., 2006	SH(NA)-080141-J	<p>Correction Section 3.1.1</p>
Oct., 2007	SH(NA)-080141-K	<p>Correction About the Generic Terms and Abbreviations, Section 1.1, Section 2.1, Section 3.1.1, Section 3.2.4, Section 3.3.2, Section 3.4.1, Section 3.4.2, Section 3.4.3, Section 3.4.12, Section 3.4.18, Section 3.4.20, Section 6.2.1, Section 6.2.2, Section 7.4, Appendix 7</p>
Jan., 2008	SH(NA)-080141-L	<p>Correction SAFETY PRECAUTIONS, CONTENTS, About the Generic Terms and Abbreviations, Section 2.2, Section 2.3, Section 4.1, Section 5.2.2</p>
May, 2008	SH(NA)-080141-M	<p>Correction SAFETY PRECAUTIONS, Compliance with the EMC and Low Voltage Directives, About the Generic Terms and Abbreviations, Section 2.1, Section 2.3, Section 3.4.1, Section 3.4.18, Section 4.1, Section 5.2.1, Section 5.3, Section 7.1, Appendix 1 to 3</p>

Japanese Manual Version SH-080132-L

This manual confers no industrial property rights or any rights of any other kind, nor does it confer any patent licenses. Mitsubishi Electric Corporation cannot be held responsible for any problems involving industrial property rights which may occur as a result of using the contents noted in this manual.

© 2000 MITSUBISHI ELECTRIC CORPORATION

INTRODUCTION

Thank you for purchasing the MELSEC-Q series programmable controller.
Before using the equipment, please read this manual carefully to develop full familiarity with the functions and performance of the Q series programmable controller you have purchased, so as to ensure correct use. Please forward a copy of this manual to the end user.

CONTENTS

SAFETY PRECAUTIONS.....	A- 1
REVISIONS	A- 4
INTRODUCTION.....	A- 6
Compliance with the EMC and Low Voltage Directives.....	A- 10
About the Generic Terms and Abbreviations	A- 10
Product Lineup	A- 10
1 OVERVIEW	1- 1 to 1- 3
1.1 Features	1- 2
1.2 Added Functions	1- 3
2 SYSTEM CONFIGURATION	2- 1 to 2- 7
2.1 Applicable Systems.....	2- 1
2.2 About Use of the Q64TD/Q64TDV-GH with the Q12PRH/Q25PRHCPU.....	2- 5
2.3 How to Check the Function Version, Product Information and Software Version	2- 6
3 SPECIFICATIONS	3- 1 to 3-41
3.1 Performance Specifications	3- 1
3.1.1 Specifications of Q64TD	3- 1
3.1.2 Specifications of Q64TDV-GH.....	3- 4
3.2 Function List.....	3- 7
3.2.1 Micro voltage input/output conversion characteristic (Q64TDV-GH only)	3- 8
3.2.2 Temperature conversion system (Q64TD).....	3- 9
3.2.3 Temperature/micro voltage conversion system (Q64TDV-GH)	3-10
3.2.4 Conversion setting for disconnection detection function	3-12
3.3 I/O Signals Transferred to/from CPU	3-13
3.3.1 I/O signal list	3-13
3.3.2 I/O signal details	3-14
3.4 Buffer Memory.....	3-19
3.4.1 Buffer memory assignment (Q64TD)	3-19
3.4.2 Buffer memory assignment (Q64TDV-GH).....	3-22
3.4.3 Conversion enable/disable setting (Un\G0)	3-25
3.4.4 CH <input type="checkbox"/> time/count averaging setting (Un\G1 to 4)	3-26
3.4.5 Averaging processing specification (Un\G9).....	3-26
3.4.6 Conversion completion flag (Un\G10)	3-27
3.4.7 CH <input type="checkbox"/> measured temperature value/micro voltage value (Un\G11 to 14)	3-28
3.4.8 Error code (Un\G19).....	3-29
3.4.9 Setting range (Q64TD) (Un\G20)	3-29
3.4.10 Setting range 1 (Q64TDV-GH) (Un\G20).....	3-30
3.4.11 Setting range 2 (Q64TDV-GH) (Un\G21).....	3-30
3.4.12 Warning output enable/disable setting (Un\G47).....	3-31

3.4.13 Warning output flag (Un\G48).....	3-31
3.4.14 Disconnection detection flag (Un\G49).....	3-32
3.4.15 CH <input type="checkbox"/> scaling value (Un\G50 to 53).....	3-33
3.4.16 CH <input type="checkbox"/> scaling range upper/lower limit values (Un\G62 to 69).....	3-33
3.4.17 CH <input type="checkbox"/> scaling width upper/lower limit values (Un\G78 to 85).....	3-34
3.4.18 CH <input type="checkbox"/> warning output upper/lower limit values (Un\G86 to 101).....	3-34
3.4.19 CH <input type="checkbox"/> offset/gain temperature value (Q64TD)/CH <input type="checkbox"/> offset/gain setting value (Q64TDV-GH) (Un\G118 to 125).....	3-36
3.4.20 Conversion setting for disconnection detection (Un\G148).....	3-37
3.4.21 Conversion setting value for disconnection detection (Un\G150 to 153).....	3-39
3.4.22 Mode switching setting (Un\G158 to 159).....	3-39
3.4.23 Factory default offset/gain value/User range settings offset/gain value/User range settings thermal EMF offset/gain value (Un\G160 to 191).....	3-40

4 SETUP AND PROCEDURES BEFORE OPERATION	4- 1 to 4-13
--	---------------------

4.1 Handling Precautions.....	4- 1
4.2 Setup and Procedures before Operation.....	4- 2
4.3 Part Names and Settings.....	4- 3
4.4 Wiring.....	4- 4
4.4.1 Wiring Instructions.....	4- 4
4.4.2 External Wiring.....	4- 4
4.5 Switch Setting for Intelligent Function Module.....	4- 6
4.6 Offset/Gain Setting.....	4- 8
4.7 Cold Junction Temperature Compensation Yes/No Setting.....	4-13

5 UTILITY PACKAGE (GX Configurator-TI)	5- 1 to 5-23
---	---------------------

5.1 Utility Package Functions.....	5- 1
5.2 Installing and Uninstalling the Utility Package.....	5- 3
5.2.1 Handling precautions.....	5- 3
5.2.2 Operating environment.....	5- 5
5.3 Utility Package Operation.....	5- 7
5.3.1 Common utility package operations.....	5- 7
5.3.2 Operation overview.....	5- 9
5.3.3 Starting the Intelligent function module utility.....	5-11
5.4 Initial Setting.....	5-13
5.5 Auto Refresh Settings.....	5-14
5.6 Monitoring/Test.....	5-16
5.6.1 Monitor/test screen.....	5-16
5.6.2 Offset/gain setting operation (Function version C or later).....	5-19
5.6.3 Offset/gain setting operation (Function version B).....	5-21
5.6.4 OMC (Online Module Change) refresh data.....	5-22

6 PROGRAMMING	6- 1 to 6-10
----------------------	---------------------

6.1 Programs Used in Normal System Configuration.....	6- 1
6.1.1 Program example when utility package is used.....	6- 2
6.1.2 Program example when utility package is not used.....	6- 3

6.2 Programs Used on Remote I/O Network	6- 4
6.2.1 Program example when utility package is used.....	6- 5
6.2.2 Program example when utility package is not used.....	6- 7

7 ONLINE MODULE CHANGE	7- 1 to 7-34
-------------------------------	---------------------

7.1 Online Module Change Conditions.....	7- 2
7.2 Online Module Change Operations	7- 3
7.3 Online Module Change Procedure	7- 4
7.3.1 When factory default is used and initial setting was made with GX Configurator-TI	7- 4
7.3.2 When factory default is used and initial setting was made with sequence program	7- 9
7.3.3 When user range setting is used and initial setting was made with GX Configurator-TI (other system is available).....	7-14
7.3.4 When user range setting is used and initial setting was made with GX Configurator-TI (other system is unavailable).....	7-19
7.3.5 When user range setting is used and initial setting was made with sequence program (other system is available).....	7-24
7.3.6 When user range setting is used and initial setting was made with sequence program (other system is unavailable).....	7-29
7.4 Range Reference Table.....	7-34
7.5 Precautions for Online Module Change	7-34

8 TROUBLESHOOTING	8- 1 to 8- 5
--------------------------	---------------------

8.1 Error Code List	8- 1
8.2 Troubleshooting	8- 2
8.2.1 RUN LED is extinguished	8- 2
8.2.2 RUN LED flickers	8- 2
8.2.3 ERROR LED flickers	8- 2
8.2.4 ERROR LED is lit	8- 2
8.2.5 Disconnection detection flag (XC) has turned on.....	8- 3
8.2.6 Measured temperature value/micro voltage conversion value cannot be read	8- 3
8.2.7 Measured temperature value is abnormal.....	8- 3
8.2.8 Micro voltage conversion value is abnormal	8- 3
8.2.9 Checking the Q64TD/Q64TDV-GH status using GX Developer system monitor.....	8- 4

APPENDIX	App.- 1 to App.-44
-----------------	---------------------------

Appendix 1 Usual Operation Limits and Superheated Operating Limits.....	App.- 1
Appendix 2 Allowable Temperature Differences.....	App.- 1
Appendix 3 Thermal Electromotive Force Chart.....	App.- 2
Appendix 3.1 Standard Thermal Electromotive Force of B	App.- 2
Appendix 3.2 Standard Thermal Electromotive Force of R	App.- 6
Appendix 3.3 Standard Thermal Electromotive Force of S	App.-10
Appendix 3.4 Standard Thermal Electromotive Force of K	App.-14
Appendix 3.5 Standard Thermal Electromotive Force of E	App.-18
Appendix 3.6 Standard Thermal Electromotive Force of J	App.-21
Appendix 3.7 Standard Thermal Electromotive Force of T.....	App.-25
Appendix 3.8 Standard Thermal Electromotive Force of N	App.-27

Appendix 4 Upgrading of Q64TD/Q64TDV-GH FunctionsApp.-31

 Appendix 4.1 Comparison between Q64TD and Q64TDV-GH FunctionsApp.-31

 Appendix 4.2 When the Q64TD/Q64TDV-GH has Product Information which First 5 Digits are
 07071 or EarlierApp.-32

Appendix 5 Dedicated InstructionApp.-33

 Appendix 5.1 Dedicated Instruction List and Available Device.....App.-33

 Appendix 5.2 G(P).OFFGANApp.-34

 Appendix 5.3 G(P).OGLOADApp.-36

 Appendix 5.4 G(P).OGSTOR.....App.-39

Appendix 6 Differences between Q64TD and Q64TDV-GHApp.-43

Appendix 7 External Dimension DiagramApp.-44

INDEX	Index- 1 to Index- 2
-------	----------------------

Compliance with the EMC and Low Voltage Directives

(1) For programmable controller system

To configure a system meeting the requirements of the EMC and Low Voltage Directives when incorporating the Mitsubishi programmable controller (EMC and Low Voltage Directives compliant) into other machinery or equipment, refer to Chapter 9 "EMC AND LOW VOLTAGE DIRECTIVES" of the QCPU User's Manual (Hardware Design, Maintenance and Inspection).
The CE mark, indicating compliance with the EMC and Low Voltage Directives, is printed on the rating plate of the programmable controller.

(2) For the product

No additional measures are necessary for the compliance of this product with the EMC and Low Voltage Directives.

About the Generic Terms and Abbreviations

Unless otherwise specified, this manual uses the following general terms and abbreviations.

Abbreviation/general terms	Description of the abbreviation/general terms
Q64TD	Abbreviation of Q64TD thermocouple input module.
Q64TDV-GH	Abbreviation of Q64TDV-GH channel isolated thermocouple/micro voltage input module.
Personal computer	IBM PC/AT [®] or compatible computer with DOS/V.
GX Developer	Generic product name for the SWnD5C-GPPW-E, SWnD5C-GPPW-EA, SWnD5C-GPPW-EV and SWnD5C-GPPW-EVA. ("n" is 4 or greater.) "-A" and "-V" denote volume license product and upgraded product respectively.
GX Configurator-TI	Generic term for thermocouple input module setting and monitor tool GX Configurator-TI (SW1D5C-QTIU-E).
QCPU (Q mode)	Generic term for Q00JCPU, Q00CPU, Q01CPU, Q02CPU, Q02HCPU, Q06HCPU, Q12HCPU, Q25HCPU, Q02PHCPU, Q06PHCPU, Q12PHCPU, Q25PHCPU, Q12PRHCPU, Q25PRHCPU, Q02UCPU, Q03UDCPU, Q04UDHCPU, Q06UDHCPU, Q13UDHCPU, Q26UDHCPU, Q03UDECPU, Q04UDEHCPU, Q06UDEHCPU, Q13UDEHCPU, Q26UDEHCPU.
Process CPU	Generic term for Q02PHCPU, Q06PHCPU, Q12PHCPU, Q25PHCPU.
Windows Vista [®]	Generic term for the following: Microsoft [®] Windows Vista [®] Home Basic Operating System, Microsoft [®] Windows Vista [®] Home Premium Operating System, Microsoft [®] Windows Vista [®] Business Operating System, Microsoft [®] Windows Vista [®] Ultimate Operating System, Microsoft [®] Windows Vista [®] Enterprise Operating System.
Windows [®] XP	Generic term for the following: Microsoft [®] Windows [®] XP Professional Operating System, Microsoft [®] Windows [®] XP Home Edition Operating System.

Product Lineup

The product lineup is given in the table below.

Type	Product	Quantity
Q64TD	Q64TD thermocouple input module	1
Q64TDV-GH	Q64TDV-GH channel isolated thermocouple/micro voltage input module	1
SW1D5C-QTIU-E	GX Configurator-TI Version 1 (Single license product) (CD-ROM)	1
SW1D5C-QTIU-EA	GX Configurator-TI Version 1 (Volume license product) (CD-ROM)	1

1 OVERVIEW

This user's manual provides the specifications, handling instructions, programming procedures and others of the Q64TD thermocouple input module (abbreviated to the Q64TD) and Q64TDV-GH channel isolated thermocouple/micro voltage input module (abbreviated to the Q64TDV-GH) used with the MELSEC-Q series CPU module (hereafter abbreviated to the CPU).

The Q64TD is a module designed to convert thermocouple input values from outside the programmable controller into 16-bit signed binary measured temperature values and 16-bit signed binary scaling values (ratios).

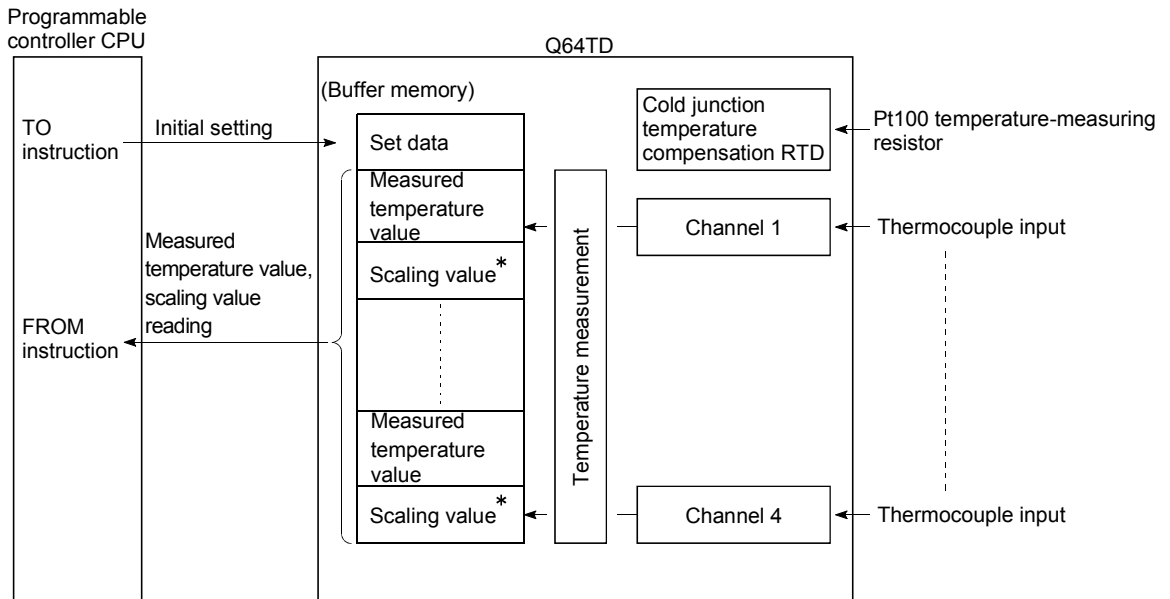

*: Refer to Section 3.4.15 for details of the scaling values.

In addition to the temperature measurement functions of the Q64TD, the Q64TDV-GH has a function that converts a micro voltage signal into a 16-bit, signed binary data.

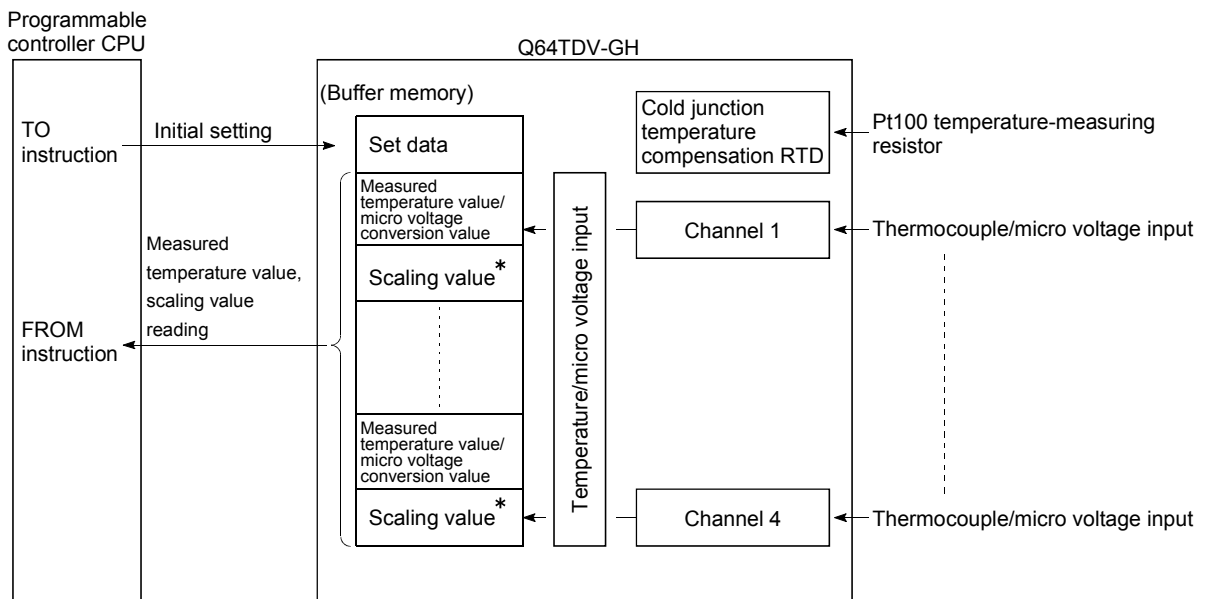

*: Refer to Section 3.4.15 for details of the scaling value.

1.1 Features

1

- (1) **Channels isolated**
Both the Q64TD and Q64TDV-GH are channel isolated modules.
- (2) **4 channels of temperatures measured by one module**
One Q64TD module can measure temperatures of four channels.
It can also convert the detected temperature values into scaling values (ratios (%)).
- (3) **Micro voltages of four channels can be converted on one module (Q64TDV-GH only)**
One Q64TDV-GH module can make micro voltage conversion of four channels.
It can also convert the detected micro voltage conversion values into scaling values (ratio values (%)).
- (4) **Setting of conversion enable/disable**
You can make a conversion enable/disable setting for each channel. Disabling unused channels for conversion reduces sampling time.
It also prevents unnecessary disconnection detection on unused channels.
- (5) **Thermocouples conforming to JIS Standards usable**
You can use eight different thermocouples (K, E, J, T, B, R, S, N) conforming to the JIS Standards. You can also select the thermocouple type for each channel using GX Developer.
- (6) **Disconnection detection**
The disconnection of a thermocouple or compensation conductor can be detected on each channel.
- (7) **Selection of sampling processing/time averaging processing/count averaging processing**
As a conversion processing method, you can choose sampling processing, time averaging processing or count averaging processing on each channel.
- (8) **Pt100 temperature-measuring resistor for cold junction temperature compensation**
The Pt100 temperature-measuring resistor connected makes cold junction temperature compensation automatically.
- (9) **Setting of Pt100 cold junction temperature compensation enable/disable**
Disabling cold junction temperature compensation with Pt100 temperature-measuring resistor enables cold junction temperature compensation to be made outside the module.
If the cold junction temperature compensation accuracy of the Pt100 temperature-measuring resistor cannot be ignored (± 1 °C), use of an external precision ice bath improves the cold junction temperature compensation accuracy.
- (10) **Error compensation by offset/gain value setting**
Error compensation can be made by setting offset and gain values on each channel. As the offset and gain values, you can make selection from user range setting and factory default setting.

(11) Warning output

If the temperature detected is outside the preset measurement range, an warning can be output on each channel.

(12) Online module change

You can perform a module change without stopping the system.

Further "inheritance of offset/gain settings to the new Q64TD/Q64TDV-GH after online module change" and "transfer of offset/gain settings to the other Q64TD/Q64TDV-GH mounted on the other slot" can be performed by executing the dedicated instructions (G(P).OGLOAD, G(P).OGSTOR) or performing write to buffer memory and turning the Y signal ON. (These functions are limited to between the modules of the same model.)

(13) Utility package for ease of setting

The optional utility package (GX Configurator-TI) is available.

Though it is not required to use the utility package, the utility package allows you to make initial setting and automatic refresh setting on-screen, reducing sequence programs and facilitating the checking of the setting and operating statuses.

1.2 Added Functions

The following is a function added for the Q64TD/Q64TDV-GH.

Item	Applicable module	Function overview	Reference section
Online module change	Function version C or later	You can change the module without stopping the system. The CPU of function version C or later is required.	Chapter 7
Mode switching that does not require CPU to be reset	Function version C or later	Using the mode switching setting (buffer memory addresses 158, 159: Un\G158, Un\G159) and operating condition setting request (Y9), the module is switched between the normal mode and offset/gain setting mode without the CPU being reset.	Section 3.4.22
		Using the dedicated instruction (G(P).OFFGAN), the module is switched between the normal mode and offset/gain setting mode without the CPU being reset.	Appendix 5.2
		Using GX Configurator-TI, the module is switched between the normal mode and offset/gain setting mode without the CPU being reset.	Section 5.6.2
Conversion setting for disconnection detection	First 5 digits of product information are 07072 or later	For values to be stored in the CH□ measured temperature value/micro voltage conversion value (buffer memory addresses 11 to 14: Un\G11 to 14) in the case of disconnection detection, any of "Value immediately before disconnection", "Up scale (maximum value of measured temperature range + 5% of measured temperature range)", "Down scale (minimum value of measured temperature range - 5% of measured temperature range)" or "Given value" can be selected.	Section 3.2.4

POINT

- (1) Refer to Appendix 4.1 for the function comparison between function versions.
- (2) For the Q64TD/Q64TDV-GH whose first 5 digits of product information are 07071 or earlier or 07072 or later, refer to Appendix 4.2.
- (3) Refer to Section 2.2 for how to check the function version and product information.

2 SYSTEM CONFIGURATION

This chapter explains the system configuration of the Q64TD/Q64TDV-GH.

2.1 Applicable Systems

This section describes the applicable systems.

(1) Applicable modules and base units, and No. of modules

(a) When mounted with a CPU module

The table below shows the CPU modules and base units applicable to the Q64TD/Q64TDV-GH and quantities for each CPU model.

Depending on the combination with other modules or the number of mounted modules, power supply capacity may be insufficient. Pay attention to the power supply capacity before mounting modules, and if the power supply capacity is insufficient, change the combination of the modules.

Applicable CPU module		No. of modules * ¹	Base unit * ²		
CPU type	CPU model		Main base unit	Extension base unit	
Programmable controller CPU	Basic model QCPU	Q00JCPU	Up to 16		
		Q00CPU	Up to 24	○	
		Q01CPU		○	
	High Performance model QCPU	Q02CPU	Up to 64	○	○
		Q02HCPU			
		Q06HCPU			
		Q12HCPU			
		Q25HCPU			
	Process CPU	Q02PHCPU	Up to 64	○	○
		Q06PHCPU			
		Q12PHCPU			
		Q25PHCPU			
	Redundant CPU	Q12PRHCPU	Up to 53 * ³	×	○
		Q25PRHCPU			
	Universal model QCPU	Q02UCPU	Up to 36	○	○
		Q03UDCPU	Up to 64		
		Q04UDHCPU			
Q06UDHCPU					
Q13UDHCPU					
Q26UDHCPU					
Q03UDECPU					
Q04UDEHCPU					
Q06UDEHCPU					
Q13UDEHCPU					
Q26UDEHCPU					
Safety CPU	QS001CPU	N/A	×	×	
C Controller module	Q06CCPU-V	Up to 64	○	○	
	Q06CCPU-V-B				

○:Applicable, ×:N/A

*1 Limited within the range of I/O points for the CPU module.

*2 Can be installed to any I/O slot of a base unit.

*3 Use the Q64TD/Q64TDV-GH whose serial No. (first five digits) is 09012 or later.

(b) Mounting to a MELSECNET/H remote I/O station

The table below shows the network modules and base units applicable to the Q64TD/Q64TDV-GH and quantities for each network module model. Depending on the combination with other modules or the number of mounted modules, power supply capacity may be insufficient. Pay attention to the power supply capacity before mounting modules, and if the power supply capacity is insufficient, change the combination of the modules.

Applicable network module	No. of modules * 1	Base unit * 2	
		Main base unit of remote I/O station	Extension base unit of remote I/O station
QJ72LP25-25	Up to 64	○	○
QJ72LP25G			
QJ72LP25GE			
QJ72BR15			

○: Applicable, ×:N/A

* 1 Limited within the range of I/O points for the network module.
 * 2 Can be installed to any I/O slot of a base unit.

Remark

The Basic model QCPU or C Controller module cannot create the MELSECNET/H remote I/O network.

(2) Support of the multiple CPU system

When using the Q64TD/Q64TDV-GH in a multiple CPU system, refer to the following manual first.

- QCPU User's Manual (Multiple CPU System)

(a) Compatible Q64TD/Q64TDV-GH

Use a Q64TD/Q64TDV-GH with function version B or higher if using the module in a multiple CPU system.

(b) Intelligent function module parameters

Write intelligent function module parameters to only the control CPU of the Q64TD/Q64TDV-GH.

(3) Compatibility with online module change

To make an online module change, use the Q64TD/Q64TDV-GH of function version C or later.

Refer to Chapter 7.

(4) Q64TD-compatible software packages

Relation between the system containing the Q64TD and software package is shown in the following table.

GX Developer is necessary when using the Q64TD.

		Software Version	
		GX Developer	GX Configurator-TI *1*2
Q00J/Q00/Q01CPU	Single CPU system	Version 7 or later	Version 1.10L or later
	Multiple CPU system	Version 8 or later	
Q02/Q02H/Q06H/ Q12H/Q25HCPU	Single CPU system	Version 4 or later	Version 1.00A or later
	Multiple CPU system	Version 6 or later	
Q02PH/Q06PHCPU	Single CPU system	Version 8.68W or later	Version 1.13P or later
	Multiple CPU system		
Q12PH/Q25PHCPU	Single CPU system	Version 7.10L or later	Version 1.14Q or later
	Multiple CPU system		
Q12PRH/Q25PRHCPU	Redundant CPU system	Version 8.45X or later	Version 1.14Q or later
Q02U/Q03UD/ Q04UDH/Q06UDHCPU	Single CPU system	Version 8.48A or later	Version 1.24AA or later
	Multiple CPU system		
Q13UDH/Q26UDHCPU	Single CPU system	Version 8.62Q or later	Version 1.24AA or later
	Multiple CPU system		
Q03UDE/Q04UDEH/ Q06UDEH/Q13UDEH/ Q26UDEHCPU	Single CPU system	Version 8.68W or later	Version 1.24AA or later
	Multiple CPU system		
If installed in a MELSECNET/H remote I/O station		Version 6 or later	Version 1.00A or later

*1 The product of Version 1.14Q or earlier is not compatible with "normal mode - offset/gain setting mode switching" and "OMC refresh data". Use the product of Version 1.15R or later.

*2 The product of Version 1.20W or earlier is not compatible with "Conversion setting for disconnection detection function". Use the product of Version 1.21X or later.

(5) Q64TDV-GH-compatible software packages

Relation between the system containing the Q64TDV-GH and software package is shown in the following table.

GX Developer is necessary when using the Q64TDV-GH.

		Software Version	
		GX Developer	GX Configurator-TI *1*2
Q00J/Q00/Q01CPU	Single CPU system	Version 7 or later	Version 1.13P or later
	Multiple CPU system	Version 8 or later	
Q02/Q02H/Q06H/ Q12H/Q25HCPU	Single CPU system	Version 4 or later	
	Multiple CPU system	Version 6 or later	
Q02PH/Q06PHCPU	Single CPU system	Version 8.68W or later	
	Multiple CPU system		
Q12PH/Q25PHCPU	Single CPU system	Version 7.10L or later	
	Multiple CPU system		
Q12PRH/Q25PRHCPU	Redundant CPU system	Version 8.45X or later	Version 1.14Q or later
Q02U/Q03UD/ Q04UDH/Q06UDHCPU	Single CPU system	Version 8.48A or later	Version 1.24AA or later
	Multiple CPU system		
Q13UDH/Q26UDHCPU	Single CPU system	Version 8.62Q or later	
	Multiple CPU system		
Q03UDE/Q04UDEH/ Q06UDEH/Q13UDEH/ Q26UDEHCPU	Single CPU system	Version 8.68W or later	
	Multiple CPU system		
If installed in a MELSECNET/H remote I/O station		Version 6 or later	Version 1.13P or later

*1 The product of Version 1.14Q or earlier is not compatible with "OMC refresh data". Use the product of Version 1.15R or later.

*2 The product of Version 1.20W or earlier is not compatible with "Conversion setting for disconnection detection function". Use the product of Version 1.21X or later.

POINT
<p>(1) The Q64TD of function version A is not available. The Q64TDV-GH of function version B is not available. The products of function version C include the functions of the products of function version A and B.</p> <p>(2) Depending on the version of GX Configurator-TI, applicable system, CPU module and functions of Q64TD / Q64TDV-GH varies.</p>

2.2 About Use of the Q64TD/Q64TDV-GH with the Q12PRH/Q25PRHCPU

Here, use of the Q64TD/Q64TDV-GH with the Q12PRH/Q25PRHCPU is explained.

(1) Dedicated instruction

The dedicated instruction cannot be used.

(2) GX Configurator-TI

When using GX Developer to access the Q12PRH/Q25PRHCPU through the intelligent function module on the extension base unit, GX Configurator-TI cannot be used.

Connect a personal computer to the Q12PRH/Q25PRHCPU with a communication path indicated below.

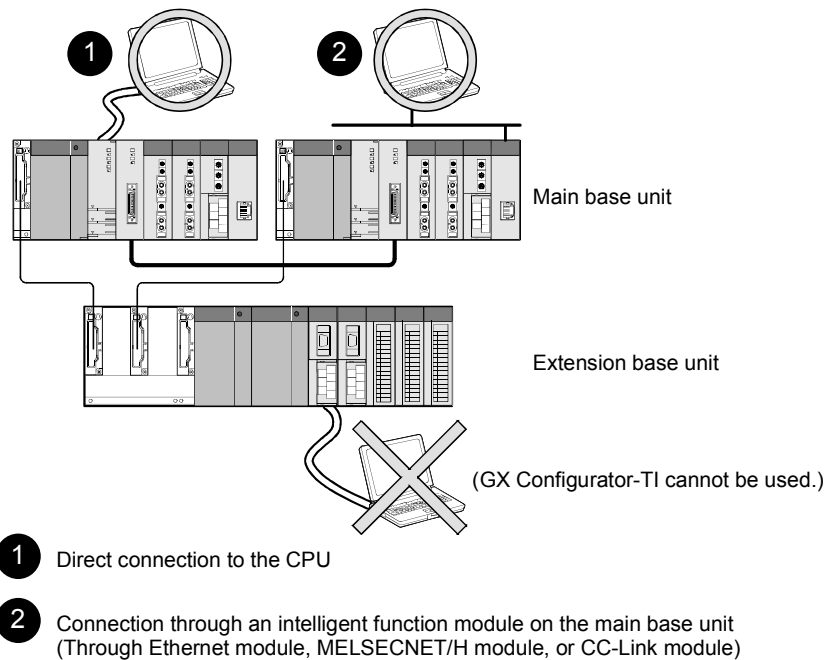

2.3 How to Check the Function Version, Product Information and Software Version

This section describes how to check the function version and product information of the Q64TD/Q64TDV-GH and the GX Configuration-TI software version.

(1) Checking the function version and product information of the Q64TD/Q64TDV-GH

- (a) To check the version using the "SERIAL column of the rating plate" located on the side of the module

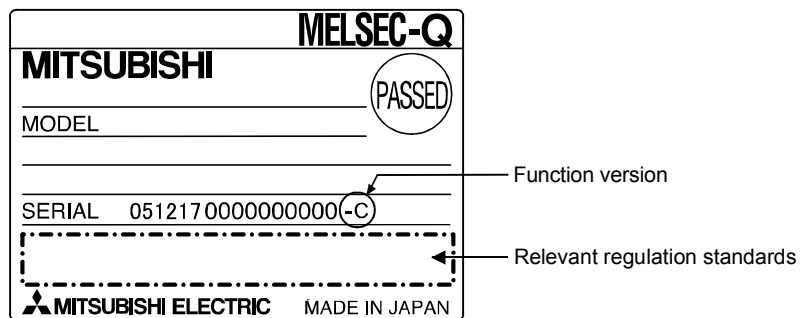

- (b) To check the function version and product information using the GX Developer
See Section 8.2.9 of this manual.

POINT

The serial No. on the rating plate may be different from the serial No. displayed on the product information screen of GX Developer.

- The serial No. on the rating plate indicates the management information of the product.
- The serial No. displayed on the product information screen of GX Developer indicates the function information of the product.

The function information of the product is updated when a new function is added.

(2) Checking the software version of GX Configurator- TI

The software version of GX Configurator- TI can be checked in GX Developer's "Product information" screen.

[Operating procedure]

GX Developer → [Help] → [Product information]

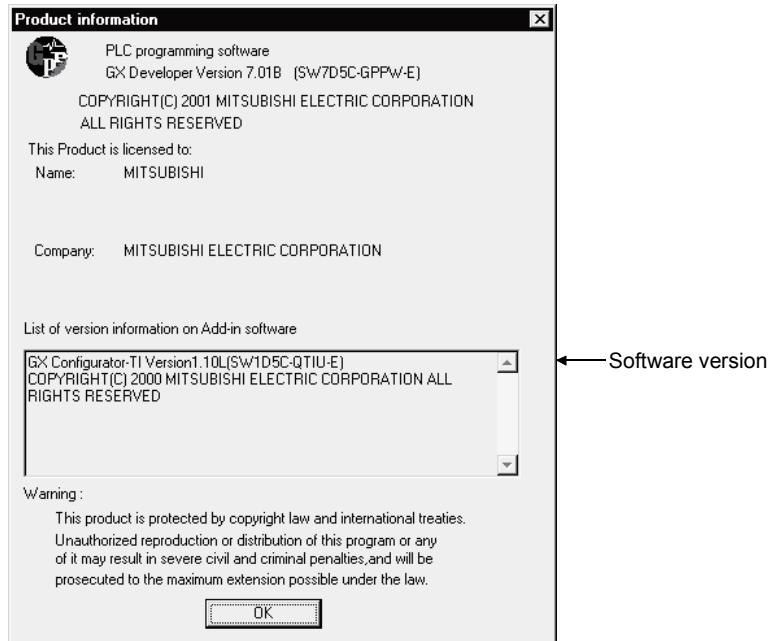

(In the case of GX Developer Version 7)

3 SPECIFICATIONS

3.1 Performance Specifications

The following are the performance specifications of the Q64TD/Q64TDV-GH.

3.1.1 Specifications of Q64TD

(1) Performance specification list

Item	Specifications															
Number of channels	4 channels															
Output	Temperature conversion value (-2700 to 18200: Value to the first decimal place × 10 times)															
	Scaling value															
Standard with which thermocouple conforms	JIS C1602-1995															
Usable thermocouples and measured temperature range accuracies	Refer to Section (2)															
Cold junction temperature compensation accuracy	±1.0°C															
Accuracy	As per calculation expression marked * 1															
Resolution	B,R,S,N : 0.3°C K,E,J,T : 0.1°C															
Conversion speed	40ms/channel * 2															
Number of analog input points	4 channels + Pt100 connection channel/module															
Isolation	<table border="1"> <thead> <tr> <th>Specific isolated area</th> <th>Isolation method</th> <th>Dielectric withstand voltage</th> <th>Isolation resistance</th> </tr> </thead> <tbody> <tr> <td>Between thermocouple input and programmable controller power supply</td> <td>Transformer isolation</td> <td rowspan="2">1780VrmsAC /3 cycles (Altitude 2000m)</td> <td>100MΩ or more using 500VDC isolation resistance tester</td> </tr> <tr> <td>Between thermocouple input channels</td> <td>Transformer isolation</td> <td>10MΩ or more using 500VDC isolation resistance tester</td> </tr> <tr> <td>Between cold junction temperature compensation channel and programmable controller power supply</td> <td>No insulation</td> <td>—</td> <td>—</td> </tr> </tbody> </table>	Specific isolated area	Isolation method	Dielectric withstand voltage	Isolation resistance	Between thermocouple input and programmable controller power supply	Transformer isolation	1780VrmsAC /3 cycles (Altitude 2000m)	100MΩ or more using 500VDC isolation resistance tester	Between thermocouple input channels	Transformer isolation	10MΩ or more using 500VDC isolation resistance tester	Between cold junction temperature compensation channel and programmable controller power supply	No insulation	—	—
	Specific isolated area	Isolation method	Dielectric withstand voltage	Isolation resistance												
	Between thermocouple input and programmable controller power supply	Transformer isolation	1780VrmsAC /3 cycles (Altitude 2000m)	100MΩ or more using 500VDC isolation resistance tester												
	Between thermocouple input channels	Transformer isolation		10MΩ or more using 500VDC isolation resistance tester												
Between cold junction temperature compensation channel and programmable controller power supply	No insulation	—	—													
Wire break detection	Yes (Each channel independent) * 3															
E ² PROM write count	Max. 100 thousand times															
Number of occupied I/O points	16 points (I/O assignment: Intelligent 16 points)															
Connection terminals	18-point terminal block															
Applicable wire size	0.3 to 0.75mm ²															
Applicable crimping terminals	1.25-3 R1.25-3(Sleeved crimping terminals are unusable)															
Internal current consumption (5VDC)	0.50A															
Weight	0.25kg															
Outline dimensions	98(H) × 27.4(W) × 112(D)mm															

* 1: Calculate the accuracy in the following method.

(Accuracy) = (conversion accuracy) + (temperature characteristic) × (operating ambient temperature variation) + (cold junction temperature compensation accuracy)

An operating ambient temperature variation indicates a deviation of the operating ambient temperature from the 25±5°C range.

Example: When the thermocouple used is B (Refer to Section 3.1.1 (2)), the operating ambient temperature is 35°C, and the measured temperature is 1000°C, the accuracy is: (±2.5°C) + (±0.4°C) × (35°C - 30°C) + (±1°C) = ±5.5°C

* 2: The conversion speed is a period from when a temperature is input and converted into a corresponding digital value until the value is stored into the buffer memory. When two or more channels are used, the conversion speed is "40ms × number of conversion enabled channels".

*3: For output in the case of disconnection detection, select any of "Value immediately before disconnection", "UP scale (maximum value of measured temperature range + 5% of measured temperature range)", "Down scale (minimum value of measured temperature range – 5% of measured temperature range)" or "Given value". (see Section 3.2.4.)

(2) Usable thermocouples and measured temperature range accuracies

This section explains the usable thermocouples and measured temperature range accuracies.

Usable Thermocouple Type	Measured Temperature Range * 1	Conversion Accuracy (At operating ambient temperature 25±5°C)	Temperature Characteristic (Per operating ambient temperature variation of 1°C)	Max. Temperature Error at Ambient Temperature 55°C
B	0 to 600°C	_____ * 3	_____ * 3	_____ * 3
	600 to 800°C * 2	±3.0°C	±0.4°C	±13.0°C
	800 to 1700°C * 2	±2.5°C		±12.5°C
	1700 to 1820°C	_____ * 3	_____ * 3	_____ * 3
R	-50 to 0°C	_____ * 3	_____ * 3	_____ * 3
	0 to 300°C * 2	±2.5°C	±0.4°C	±12.5°C
	300 to 1600°C * 2	±2.0°C	±0.3°C	±9.5°C
	1600 to 1760°C	_____ * 3	_____ * 3	_____ * 3
S	-50 to 0°C	_____ * 3	_____ * 3	_____ * 3
	0 to 300°C * 2	±2.5°C	±0.4°C	±12.5°C
	300 to 1600°C * 2	±2.0°C	±0.3°C	±9.5°C
	1600 to 1760°C	_____ * 3	_____ * 3	_____ * 3
K	-270 to -200°C	_____ * 3	_____ * 3	_____ * 3
	-200 to 0°C * 2	Larger value of ±0.5°C and ±0.5% of measured temperature	Larger value of ±0.06°C and ±0.2% of measured temperature	±11.0°C
	0 to 1200°C * 2	Larger value of ±0.5°C and ±0.25% of measured temperature	Larger value of ±0.06°C and ±0.02% of measured temperature	±9.0°C
	1200 to 1370°C	_____ * 3	_____ * 3	_____ * 3
E	-270 to -200°C	_____ * 3	_____ * 3	_____ * 3
	-200 to 0°C * 2	Larger value of ±0.5°C and ±0.5% of measured temperature	Larger value of ±0.06°C and ±0.15% of measured temperature	±8.5°C
	0 to 900°C * 2	Larger value of ±0.5°C and ±0.25% of measured temperature	Larger value of ±0.06°C and ±0.02% of measured temperature	±6.75°C
	900 to 1000°C	_____ * 3	_____ * 3	_____ * 3
J	-210 to -40°C	_____ * 3	_____ * 3	_____ * 3
	-40 to 750°C * 2	Larger value of ±0.5°C and ±0.25% of measured temperature	Larger value of ±0.06°C and ±0.02% of measured temperature	±5.625°C
	750 to 1200°C	_____ * 3	_____ * 3	_____ * 3
T	-270 to -200°C	_____ * 3	_____ * 3	_____ * 3
	-200 to 0°C * 2	Larger value of ±0.5°C and ±0.5% of measured temperature	Larger value of ±0.06°C and ±0.1% of measured temperature	±6.0°C
	0 to 350°C * 2	Larger value of ±0.5°C and ±0.25% of measured temperature	Larger value of ±0.06°C and ±0.02% of measured temperature	±2.625°C
	350 to 400°C	_____ * 3	_____ * 3	_____ * 3
N	-270 to -200°C	_____ * 3	_____ * 3	_____ * 3
	-200 to 0°C * 2	Larger value of ±0.5°C and ±0.5% of measured temperature	Larger value of ±0.06°C and ±0.2% of measured temperature	±11.0°C
	0 to 1250°C * 2	Larger value of ±0.5°C and ±0.25% of measured temperature	Larger value of ±0.06°C and ±0.02% of measured temperature	±9.375°C
	1250 to 1300°C	_____ * 3	_____ * 3	_____ * 3

* 1: If a value entered from the thermocouple is outside the measured temperature range given in the table, it is handled as the maximum/minimum value of the measured temperature range.

* 2: The accuracies only in the temperature ranges of Class 1 to 3 (shaded areas) in JIS C1602-1995 apply.

* 3: Temperature measurement can be made, but accuracy is not guaranteed.

3.1.2 Specifications of Q64TDV-GH

(1) Performance specifications

Item		Specifications			
Number of channels		4 channels			
Output	Temperature conversion value	16-bit, signed binary (-2700 to 18200: Value to the first decimal place × 10 times)			
	Micro voltage conversion value	16-bit signed binary (-25000 to 25000)			
	Scaling value	16-bit, signed binary			
Standard with which thermocouple conforms		JIS C1602-1995			
Usable thermocouples and measured temperature range accuracies		Refer to Section (2)			
Cold junction temperature compensation accuracy		±1.0°C			
Thermocouple input accuracy		As per calculation expression marked *1			
Micro voltage input range		-100mV to +100mV (input resistance 2MΩ or more)			
Micro voltage input accuracy		Refer to Section (3)			
Resolution	Thermocouple input	B:0.7°C R,S:0.8°C K,T:0.3°C E:0.2°C J:0.1°C N:0.4°C			
	Micro voltage input	4μV			
Sampling period		20ms/channel *2			
Conversion speed		Sampling period × 3 *3			
Number of analog input points		4 channels + Pt100 connection channel/module			
Absolute maximum input		±5V			
Isolation	Specific isolated area	Isolation method	Dielectric withstand voltage	Isolation resistance	
	Between thermocouple input/micro voltage input and programmable controller power supply	Transformer isolation	1780VrmsAC/3 cycles (Altitude 2000m)	100MΩ or more using 500VDC isolation resistance tester	
	Between thermocouple input/micro voltage input channels	Transformer isolation		10MΩ or more using 500VDC isolation resistance tester	
	Between cold junction temperature compensation channel and programmable controller power supply	No insulation	—	—	
Wire break detection		Yes (Each channel independent) *4			
E ² PROM write count		Max. 100 thousand times			
Number of occupied I/O points		16 points (I/O assignment: Intelligent 16 points)			
Connection terminals		18-point terminal block			
Applicable wire size		0.3 to 0.75mm ²			
Applicable crimping terminals		1.25-3 R1.25-3(Sleeved crimping terminals are unusable)			
Internal current consumption (5VDC)		0.50A			
Weight		0.25kg			
Outline dimensions		98(H) × 27.4(W) × 112(D)mm			

*1: Calculate the accuracy in the following method.

(Accuracy) = (conversion accuracy) + (temperature characteristic) × (operating ambient temperature variation) + (cold junction temperature compensation accuracy)

An operating ambient temperature variation indicates a deviation of the operating ambient temperature from the 25±5°C range.

Example: When the thermocouple used is B (Refer to Section 3.1.2 (2)), the operating ambient temperature is 35°C, and the measured temperature is 1000°C, the accuracy is: (±3.5°C) + (±0.4°C) × (35°C - 30°C) + (±1°C) = ±6.5°C

*2: A period until a thermocouple input value/micro voltage input value is converted into a measured temperature value/micro voltage conversion value.

*3: A period until a thermocouple input value/micro voltage input value is converted into a measured temperature value/micro voltage conversion value and the resultant value is stored into the buffer memory.

The conversion speed is a delay time that occurs during sampling processing. It is independent of averaging processing.

Example: When two channels are enabled for conversion

$$\begin{aligned} \text{(Conversion speed)} &= (\text{sampling period}) \times 3 \\ &= (20\text{ms} \times 2 \text{ channels}) \times 3 \\ &= 120\text{ms} \end{aligned}$$

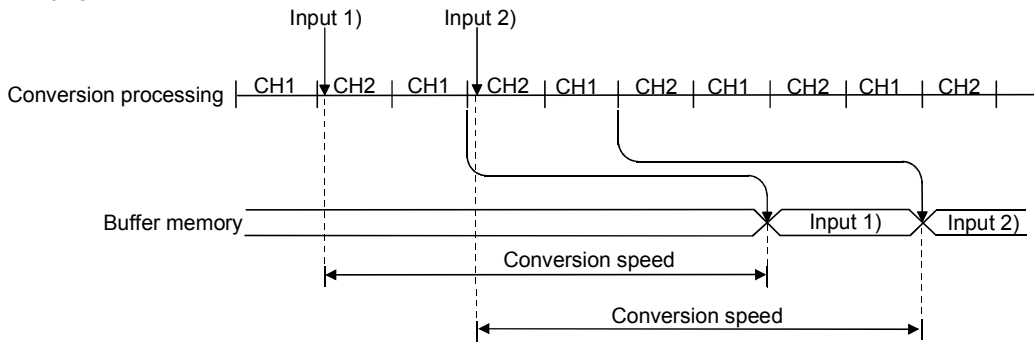

*4: For output in the case of disconnection detection, select any of "Value immediately before disconnection", "Up scale (maximum value of measured temperature range + 5% of measured temperature range)", "Down scale (minimum value of measured temperature range - 5% of measured temperature range)" or "Given value". (see Section 3.2.4.)

(2) Usable Thermocouples and Measured Temperature Range Accuracies

The usable thermocouples and measured temperature range accuracies will be explained.

Usable Thermocouple Type	Measured Temperature Range * 1	Conversion Accuracy (At operating ambient temperature 25±5°C)		Temperature Characteristic (Per operating ambient temperature variation of 1°C)	Max. Temperature Error at Ambient Temperature 55°C
		(At 25±5°C operating ambient temperature)	(At 0 to 55°C operating ambient temperature)		
B	0 to 600°C	_____ * 3	_____ * 3	_____ * 3	_____ * 3
	600 to 800°C * 2	±4.0°C	±0.4°C	±0.4°C	±14.0°C
	800 to 1700°C * 2	±3.5°C	±0.4°C		±13.5°C
	1700 to 1820°C	_____ * 3	_____ * 3	_____ * 3	_____ * 3
R	-50 to 0°C	_____ * 3	_____ * 3	_____ * 3	_____ * 3
	0 to 300°C * 2	±4.0°C	±0.4°C	±0.4°C	±14.0°C
	300 to 1600°C * 2	±3.5°C	±0.4°C		±13.5°C
	1600 to 1760°C	_____ * 3	_____ * 3	_____ * 3	_____ * 3
S	-50 to 0°C	_____ * 3	_____ * 3	_____ * 3	_____ * 3
	0 to 300°C * 2	±4.0°C	±0.4°C	±0.4°C	±14.0°C
	300 to 1600°C * 2	±3.5°C	±0.4°C		±13.5°C
	1600 to 1760°C	_____ * 3	_____ * 3	_____ * 3	_____ * 3
K	-270 to -200°C	_____ * 3	_____ * 3	_____ * 3	_____ * 3
	-200 to 0°C * 2	±2.0°C	±0.25°C	±0.25°C	±8.25°C
	0 to 200°C * 2	±1.5°C			±7.75°C
	0 to 1200°C * 2	±2.0°C			±8.25°C
	1200 to 1370°C	_____ * 3	_____ * 3	_____ * 3	_____ * 3
E	-270 to -200°C	_____ * 3	_____ * 3	_____ * 3	_____ * 3
	-200 to 200°C * 2	±1.5°C	±0.15°C	±0.15°C	±5.25°C
	200 to 900°C * 2	±2.0°C			±5.75°C
	900 to 1000°C	_____ * 3	_____ * 3	_____ * 3	_____ * 3
J	-210 to -40°C	_____ * 3	_____ * 3	_____ * 3	_____ * 3
	-40 to 200°C * 2	±1.5°C	±0.15°C	±0.15°C	±5.25°C
	200 to 750°C * 2	±2.0°C			±5.75°C
	750 to 1200°C	_____ * 3	_____ * 3	_____ * 3	_____ * 3
T	-270 to -200°C	_____ * 3	_____ * 3	_____ * 3	_____ * 3
	-200 to 0°C * 2	±2.0°C	±0.1°C	±0.1°C	±4.5°C
	0 to 350°C * 2	±1.5°C			±4.0°C
	350 to 400°C	_____ * 3	_____ * 3	_____ * 3	_____ * 3
N	-270 to -200°C	_____ * 3	_____ * 3	_____ * 3	_____ * 3
	-200 to 0°C * 2	±2.5°C	±0.25°C	±0.25°C	±8.75°C
	0 to 200°C * 2	±2.0°C			±8.25°C
	0 to 1250°C * 2	±2.5°C			±8.75°C
	1250 to 1300°C	_____ * 3	_____ * 3	_____ * 3	_____ * 3

* 1: If a value entered from the thermocouple is outside the measured temperature range given in the table, it is handled as the maximum/minimum value of the measured temperature range.

* 2: The accuracies only in the temperature ranges of Class 1 to 3 (shaded areas) in JIS C1602-1995 apply.

* 3: Temperature measurement can be made, but accuracy is not guaranteed.

(3) Micro voltage input range and accuracies

The micro voltage input range and accuracies will be explained.

Input Type	Measurable Voltage Range	Conversion Accuracy	
		(At 25±5°C operating ambient temperature)	(At 0 to 55°C operating ambient temperature)
Micro voltage input	-100 to 100mV	±0.2mV	±0.8mV

3.2 Function List

The following table lists the Q64TD/Q64TDV-GH functions.

Item	Description	Refer To
Temperature conversion function	This function allows temperature data to be imported by connecting a thermocouple. Temperature data are 16-bit signed binary (-2700 to 18200) and stored into buffer memory.	Section 3.4.7
Micro voltage conversion function (Q64TDV-GH only)	This function converts a -100mV to +100mV micro voltage into a 16-bit, signed binary (-25000 to 25000) and stores it into the buffer memory.	—
Temperature conversion system (Q64TD)	(1) Sampling processing A temperature input value is converted into a temperature one by one on each channel and a measured temperature value is output after every conversion. (2) Averaging processing Temperature conversion is averaged by count or time on each channel and an averaged value is stored.	Section 3.2.2
Temperature/micro voltage conversion system (Q64TDV-GH)	(1) Sampling processing A temperature/micro voltage input value is converted one by one on each channel and a measured temperature value is output after every conversion. (2) Averaging processing Temperature conversion is averaged by count or time on each channel and an averaged value/micro voltage conversion value is stored.	Section 3.2.3
Conversion enable/disable function	This function specifies whether temperature/micro voltage conversion is enabled or disabled on each channel. Setting temperature/micro voltage conversion enable/disable reduces the processing time of unused channels. In addition, it prevents unnecessary disconnection detection of unused channels.	Section 3.4.3 Section 3.4.6
Input type selection function	This function sets the input type per channel.	Section 4.5
Disconnection detection function	This function detects the disconnection of the connected thermocouple/micro voltage signal cable on each channel.	Section 3.4.14
Conversion setting for disconnection detection function	For values to be stored in the CH□ measured temperature value/micro voltage value (buffer memory addresses 11 to 14: Un\G11 to 14) in the case of disconnection detection, any of "Value immediately before disconnection", "Up scale (maximum value of measured temperature range + 5% of measured temperature range)", "Down scale (minimum value of measured temperature range - 5% of measured temperature range)" or "Given value" can be selected.	Section 3.2.4
Pt100 cold junction temperature compensation yes/no setting function	This function determines whether cold junction temperature compensation is made or not using the Pt100 attached to the terminals. Use this function when you want to measure temperatures at so high accuracy that the cold junction temperature compensation accuracy ($\pm 1^{\circ}\text{C}$) of the Pt100 cannot be ignored as an error. The cold junction temperature compensation accuracy can be improved by disabling the cold junction temperature compensation of the Pt100 and providing a precision ice bath externally.	Section 4.7
Warning output function	This function outputs a warning if a temperature/micro voltage falls outside the user-set temperature/micro voltage input range.	Section 3.4.13 Section 3.4.18
Scaling function	This function can convert a measured temperature value/micro voltage conversion value into a preset range ratio (%) and import it into buffer memory.	Section 3.4.15 Section 3.4.16 Section 3.4.17
Offset/gain setting function	This function compensates for an error of a measured temperature value or changes the conversion characteristic of a micro voltage conversion value.	Section 3.4.19 Section 4.6
Online module change	A module change is made without the system being stopped.	Chapter 7

3.2.1 Micro voltage input/output conversion characteristic (Q64TDV-GH only)

A micro voltage input/output conversion characteristic indicates the slope of a straight line that connects an offset value and gain value when an external micro voltage signal is converted into a digital value.

Offset value

A micro voltage input value whose digital output value will be -25000.

Gain value

A micro voltage input value whose digital output value will be 25000.

The following indicates the micro voltage input/output conversion characteristic as set at the factory (offset value: -100mV, gain value: 100mV).

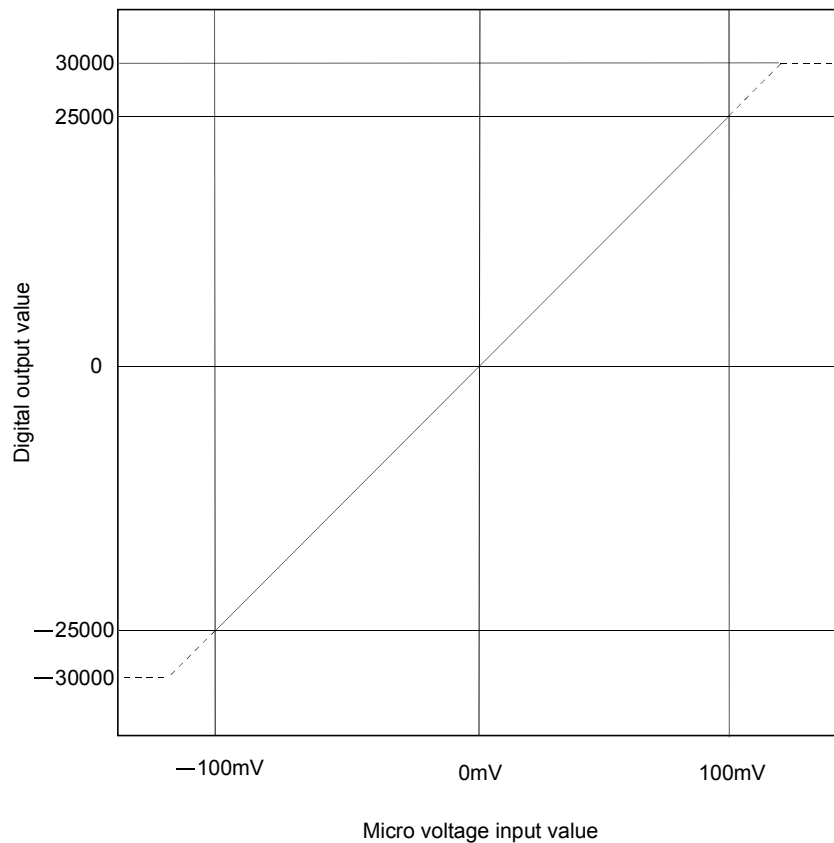

POINT
(1) Use the module within the micro voltage input range and digital output range. Outside those ranges, the maximum resolution and accuracy may not fall within the ranges of the performance specifications. (Avoid using the dotted line areas in the chart.)
(2) Do not input $\pm 5V$ or more. Doing so may damage the elements.

3.2.2 Temperature conversion system (Q64TD)

There are two temperature conversion systems, sampling processing and averaging processing.

(1) Sampling processing

A temperature input value is converted into a measured temperature value successively and the digital output value is stored into the buffer memory. Sampling processing time varies with the number of used channels (number of channels set to enable temperature conversion).

$$(\text{Processing time}) = (\text{number of used channels}) \times (40\text{ms})$$

[Example]

Sampling time is 120ms when three channels, channels 1, 2 and 4, are enabled for conversion.

$$\underline{3 \text{ channels} \times 40\text{ms} = 120\text{ms}}$$

(2) Averaging processing

The temperatures of the channels specified for averaging processing are converted by the preset count or for the preset period of time, the sum of the resultant values except the maximum and minimum values is averaged, and the result is stored into the buffer memory.

Averaging processing requires at least 2 times of conversion processing excluding the maximum and the minimum values.

(a) Time averaging processing

The processing count within the preset time varies with the number of used channels (number of channels set to enable temperature conversion).

$$(\text{Processing count}) = \frac{(\text{preset time})}{(\text{number of used channels}) \times (40\text{ms})}$$

Setting range of preset time is 160 to 5000ms.

When setting a value out of the setting range, an error (error code 20□) occurs.

[Example]

The sampling count is 4.75 when four channels, channels 1, 2, 3 and 4, are enabled for conversion and the preset time is 760ms.

$$\underline{760\text{ms} \div (4 \text{ channels} \times 40\text{ms}) = 4.75}$$

Since the fractional portion of an indivisible value is dropped, the sampling count is 4 times.

(b) Count averaging processing

The time taken to store a count-averaged value into buffer memory varies with the number of used channels (number of channels set to enable temperature conversion).

$$(\text{Processing time}) = (\text{preset count}) \times (\text{number of used channels}) \times (40\text{ms})$$

Setting range of preset count is 4 to 62500times.

When setting a value out of the setting range, an error (error code 30□) occurs.

[Example]

An average value is output ever 320ms when two channels, channels 3 and 4, are enabled for conversion and the preset count is 4.

$$\underline{4 \text{ times} \times (2 \text{ channels} \times 40\text{ms}) = 320\text{ms}}$$

3.2.3 Temperature/micro voltage conversion system (Q64TDV-GH)

Temperature/micro voltage conversion can either be made by sampling processing or averaging processing.

(1) Sampling processing

A temperature/micro voltage input value is converted successively and a digital output value is stored into the buffer memory.

The conversion speed changes depending on the number of channels used (number of channels set for conversion enable).

$$\begin{aligned} (\text{Conversion speed}) &= (\text{sampling period}) \times 3 \\ &= \{(\text{number of used channels}) \times (20\text{ms})\} \times 3 \end{aligned}$$

[Example] When 2 channels are enabled for conversion

$$\begin{aligned} (\text{Conversion speed}) &= (\text{sampling period}) \times 3 \\ &= (20\text{ms} \times 2 \text{ channels}) \times 3 \\ &= 120\text{ms} \end{aligned}$$

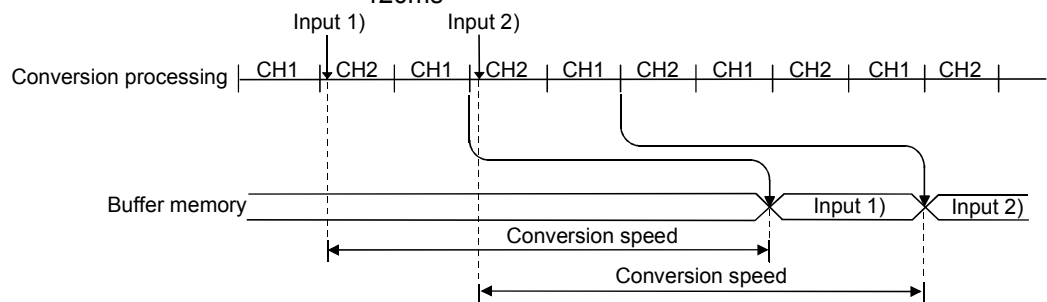

(2) Averaging processing

The input value of the channel specified for averaging processing is converted by the preset number of times or for the preset period of time, the sum of the resultant values except the maximum and minimum values is averaged, and the average value is stored into the buffer memory.

Averaging processing requires at least 2 times of conversion processing excluding the maximum and the minimum values.

(a) Time averaging processing

The number of processings performed within the preset time changes depending on the number of channels used (number of channels set for conversion enable).

$$(\text{Processing count}) = \frac{(\text{preset time})}{(\text{number of used channels}) \times (20\text{ms})}$$

Setting range of preset time is 80 to 2500ms.

When setting a value out of the setting range, an error (error code 20□) occurs.

[Example]

When four channels, channels 1, 2, 3 and 4, are enabled for conversion and the preset time is 760ms, the sampling count is 9.5.

$$\frac{760\text{ms}}{4 \text{ channels} (20\text{ms})} = 9.5$$

If the result cannot be divided, its fractional portion is rounded down and the sampling count is 4 times.

(b) Count averaging processing

The time when the count-based average value is stored into the buffer memory changes depending on the number of channels used (number of channels set for conversion enable).

$$(\text{Processing time}) = (\text{preset count}) \times (\text{number of used channels}) \times (20\text{ms})$$

Setting range of preset count is 4 to 62500ms.

When setting a value out of the setting range, an error (error code 30□) occurs.

[Example]

When two channels, channels 3 and 4, are enabled for conversion and the preset count is 4, the average value is output per 320ms.

$$\underline{4 \text{ times} \times (2 \text{ channels} \times 20\text{ms}) = 160\text{ms}}$$

3.2.4 Conversion setting for disconnection detection function

- (1) For values to be stored in the CH□ measured temperature value/micro voltage value (buffer memory addresses 11 to 14: Un\G11 to 14) in the case of disconnection detection, any of "Value immediately before disconnection", "Up scale (maximum value of measured temperature range + 5% of measured temperature range)", "Down scale (minimum value of measured temperature range – 5% of measured temperature range)" or "Given value" can be selected. Setting is available for each channel.
- (2) This function can be utilized only for channels where temperature conversion is enabled.
- (3) When Up scale (1H) or Down scale (2H) is set, an Up scale value (maximum value of measured temperature range + 5% of measured temperature range) or a Down scale value (minimum value of measured temperature range – 5% of measured temperature range) of the individual range is stored respectively.

Input type	Set value	Measurement range	Up scale	Down scale
Thermocouple K	0	-270 to 1370°C	1452.0°C	-352.0°C
Thermocouple E	1	-270 to 1000°C	1063.5°C	-333.5°C
Thermocouple J	2	-210 to 1200°C	1270.5°C	-280.5°C
Thermocouple T	3	-270 to 400°C	433.5°C	-303.5°C
Thermocouple B	4	0 to 1820°C	1911.0°C	-91.0°C
Thermocouple R	5	-50 to 1760°C	1850.5°C	-140.5°C
Thermocouple S	6	-50 to 1760°C	1850.5°C	-140.5°C
Thermocouple N	7	-270 to 1300°C	1378.5°C	-348.5°C
Micro voltage input	8	-30000 to 30000°C	32767 *	-32768 *

* For the Up scale and Down scale of the micro voltage input, the maximum and minimum of the micro voltage conversion values are applied.

- (4) When Given value(3H) is selected, set a value for the CH□ conversion setting for disconnection detection (buffer memory addresses 150 to 153: Un\G150 to 153) in units of 0.1°C.
The value set in the area is stored in CH□ measured temperature value/micro voltage value when disconnection is detected.

3.3 I/O Signals Transferred to/from CPU

This section describes the I/O signal assignment and signal functions.

3.3.1 I/O signal list

The following are the I/O signals of the Q64TD/Q64TDV-GH.

The I/O numbers (X/Y) given in this chapter and later assume that the first I/O number of the Q64TD is set to 0.

Input Signal (Signal Direction: Programmable controller CPU ← Q64TD/Q64TDV-GH)		Output Signal (Signal Direction: Programmable controller CPU → Q64TD/Q64TDV-GH)	
Device No.	Signal name	Device No.	Signal name
X0	Module Ready	Y0	Reserved *
X1	CH1 Offset/Gain Setting Status Signal	Y1	CH1 Offset Setting Request
X2	CH2 Offset/Gain Setting Status Signal	Y2	CH1 Gain Setting Request
X3	CH3 Offset/Gain Setting Status Signal	Y3	CH2 Offset Setting Request
X4	CH4 Offset/Gain Setting Status Signal	Y4	CH2 Gain Setting Request
X5	Reserved *	Y5	CH3 Offset Setting Request
X6		Y6	CH3 Gain Setting Request
X7		Y7	CH4 Offset Setting Request
X8		Y8	CH4 Gain Setting Request
X9	Operating Condition Setting Completion Signal	Y9	Operating Condition Setting Request
XA	Offset/Gain Setting Mode Status Flag	YA	User Range Write Request
XB	Reserved *	YB	Reserved *
XC	Disconnection Detection Flag	YC	
XD	Warning Output Signal	YD	
XE	Conversion Completion Flag	YE	
XF	Error Flag	YF	Error Clear Request

POINT

The reserved signals marked * are used by the system and are unavailable for the user. Should they be turned on/off in a sequence program, we cannot guarantee the functions of the Q64TD/Q64TDV-GH.

REMARK

Between the Q64TD/Q64TDV-GH whose first 5 digits of product information are 07071 or earlier and those of 07072 or later, the Conversion Completion Flag (XE) operation is different.

For details, refer to Appendix 4.2.

3.3.2 I/O signal details

The following are details of the Q64TD/Q64TDV-GH I/O signals.

(1) Input signals

Device No.	Signal Name	Description
X0	Module Ready	<p>(1) If the module is in the normal mode at power-on or resetting of the programmable controller CPU, this signal turns on to start conversion processing as soon as it gets ready for conversion.</p> <p>(2) When this signal (X0) is off in the normal mode, conversion processing is not performed. In the offset/gain setting mode, conversion processing is performed if this signal (X0) is off.</p> <p>(3) This signal (X0) turns off when:</p> <ul style="list-style-type: none"> • The module is in the offset/gain setting mode; • The Q64TD/Q64TDV-GH is in a watchdog timer error *1; or • The module can be changed during online module change
X1 X2 X3 X4	CH□ Offset/Gain Setting Status Signal	<p>(1) This signal is used as an interlock condition to turn on/off the CH□ Offset Setting Request (Y1, Y3, Y5, Y7)/CH□ Gain Setting Request (Y2, Y4, Y6, Y8) when offset/gain setting is made.</p> <p>(2) When the CH□ Offset Setting Request (Y1, Y3, Y5, Y7) or CH□ Gain Setting Request (Y2, Y4, Y6, Y8) is turned from ON to OFF in the offset/gain setting mode, this signal (X1 to 4) corresponding to the user range setting, conversion-enabled channel turns on.</p>
X9	Operating Condition Setting Completion Signal	<p>(1) This signal is used as an interlock condition to turn on/off the Operating Condition Setting Request (Y9) when the "Conversion enable/disable setting", "CH□ time/count averaging setting", "Averaging processing specification", "Warning output enable/disable setting", "Scaling range upper/lower limit value", "CH□ scaling width upper/lower limit value", "CH□ warning output upper/lower limit value", "Conversion setting for disconnection detection" or "CH□ Conversion setting value for disconnection detection" is changed.</p> <p>(2) Conversion processing is not performed when this signal (X9) is off.</p> <p>(3) This signal (X9) turns off when:</p> <ul style="list-style-type: none"> • The Module Ready (X0) is off in the normal mode; or • The Operating Condition Setting Request (Y9) is on.

*1 Occurs if program operation is not completed within the intended time due to a hardware fault of the Q64TD/Q64TDV-GH. The RUN LED of the Q64TD/Q64TDV-GH goes off when a watchdog timer error occurs.

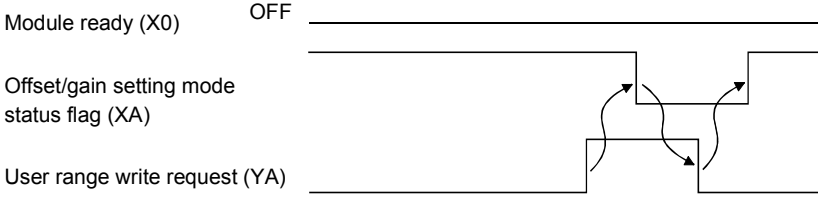
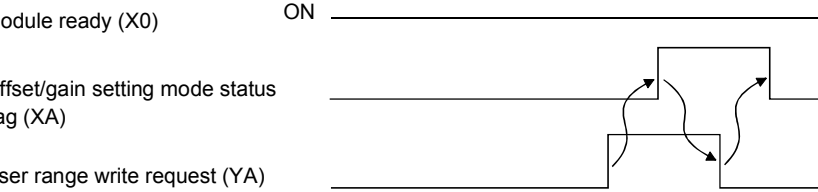
Device No.	Signal Name	Description
XA	Offset/Gain Setting Mode Status Flag	<p>[In offset/gain setting mode]</p> <p>(1) This signal is used as an interlock condition to turn ON/OFF the User range write request (YA) when the value at completion of offset/gain setting adjustment is registered.</p> <p>(2) See Section 4.6 regarding the offset/gain settings.</p> 
		<p>[In normal mode]</p> <p>(1) This signal is used as an interlock condition to turn ON/OFF the User range write request (YA) when the user range is restored.</p> <p>(2) Refer to Chapter 7 for the user range restoration.</p> 
XC	Disconnection Detection Flag	<p>(1) The input circuit for the thermocouple of the conversion-enabled channel turns ON the Disconnection Detection Flag (XC) when any input signal line including the thermocouple/micro voltage signal line is disconnected.</p> <p>For the channel where disconnection is detected, a value based on the Conversion setting for disconnection detection (buffer memory address 148: Un\G148) is stored in the CH□ measured temperature value/micro voltage conversion value (buffer memory addresses 11 to 14: Un\G11 to 14).</p> <p>Conversion of the channels not disconnected is continued.</p> <p>(2) For temperature conversion values to be stored when the Disconnection Detection Flag (XC) turns ON, any of "Value immediately before disconnection", "Up scale (maximum value of measured temperature range + 5% of measured temperature range)", "Down scale (minimum value of measured temperature range - 5% of measured temperature range)" or "Given value" can be selected. (Refer to Section 3.2.2.)</p> <p>(3) Removing the cause of disconnection and turning ON the Error Clear Request (YF) turns OFF the Disconnection Detection Flag (XC).</p> <p>(4) When the line connection is recovered, the temperature conversion value update is restarted independently of the Disconnection Detection Flag (XC) reset.</p>
XD	Warning Output Signal	<p>(1) This signal turns on when the measured temperature value/micro voltage conversion value has fallen out of the temperature range set in the warning output upper/lower limit values (buffer memory addresses 86 to 101: Un\G86 to 101) on any of the channels enabled for conversion.</p> <p>(2) This signal turns off automatically as soon as the measured temperature value/micro voltage conversion value returned to within the ranges on all channels enabled for conversion.</p>

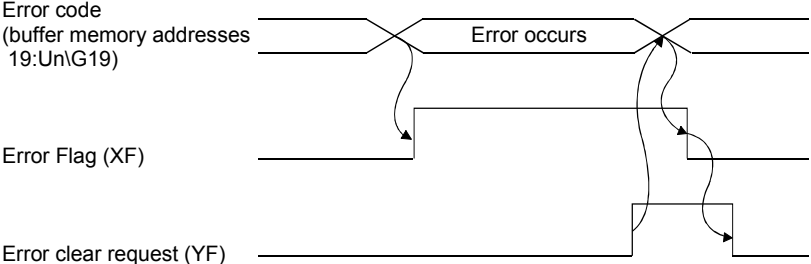
Device No.	Signal Name	Description
XE	Conversion Completion Flag	<p>(1) This signal (XE) turns on when the measured temperature value/micro voltage conversion value of all channels enabled for conversion are stored into buffer memory after power-on or hardware reset.</p> <p>(2) When averaging processing is performed, this signal also turns on when the measured temperature value/micro voltage conversion value are stored into buffer memory after completion of averaging processing.</p> <p>(3) This signal (XE) varies as described below depending on whether the Operation Condition Setting Completed Signal (X9) has turned on or off.</p> <ul style="list-style-type: none"> • When the Operation Condition Setting Completed Signal (X9) has turned on (stop → conversion) <ol style="list-style-type: none"> 1) Temperature conversions of the enabled channels are started. 2) After the measured temperature value/micro voltage conversion value are stored into buffer memory, the Conversion completion flags (buffer memory address 10: Un\G10) are turned on. 3) This signal (XE) is turned on after the measured temperature value/micro voltage conversion value of all channels enabled for conversion are stored into buffer memory. • When the Operation Condition Setting Completed Signal (X9) has turned off (conversion → stop) <ol style="list-style-type: none"> 1) The Conversion completion flags (buffer memory address 10: Un\G10) of all channels are turned off. 2) This signal (XE) is turned off. <p>Note that if conversion is stopped, the measured temperature value/micro voltage conversion value stored in buffer memory are held at the data immediately before the stop.</p> <p>(4) This signal (XE) does not turn on when all channels are disabled for conversion.</p>
XF	Error Flag	<p>(1) This signal (XF) turns on when an error occurs.</p> <p>(2) To clear the error code, turn on the Error Clear Request (YF).</p>  <p>The diagram shows three signals over time: Error code (buffer memory addresses 19:Un\G19), Error Flag (XF), and Error clear request (YF). The Error code signal is active during an 'Error occurs' period. The Error Flag (XF) signal transitions from low to high when the error occurs and returns to low when the Error clear request (YF) signal transitions from low to high.</p>

(2) Output signals

Device No.	Signal name	Description
Y1 Y3 Y5 Y7	CH□ Offset Setting Request	<p>(1) This signal is made valid in the offset/gain setting mode.</p> <p>(2) This signal corrects the measured temperature value/micro voltage conversion value to be an offset value when it is on.</p> <p>(3) When this signal turns on while the Gain Setting Request on the same channel is on or they turn on simultaneously, an error will occur and the operation in (2) not performed.</p> <p>(4) For the on/off timing, refer to the field of the CH□ Offset/Gain Setting Status Signal (X1 to 4).</p>
Y2 Y4 Y6 Y8	CH□ Gain Setting Request	<p>(1) This signal is made valid in the offset/gain setting mode.</p> <p>(2) This signal corrects the measured temperature value/micro voltage conversion value to be a gain set value when it is on.</p> <p>(3) When this signal turns on while the Offset Setting Request on the same channel is on or they turn on simultaneously, an error will occur and the operation in (2) not performed.</p> <p>(4) For the on/off timing, refer to the field of the CH□ Offset/Gain Setting Status Signal (X1 to 4).</p>
Y9	Operating Condition Setting Request	<p>(1) This signal is turned on when the "Conversion enable/disable setting", "CH□ time/count averaging setting", "Averaging processing specification", "Warning output enable/disable setting", "CH□ scaling range upper/lower limit value", "CH□ scaling width upper/lower limit value", "CH□ warning output upper/lower limit value", "Mode switching setting", "Conversion setting for disconnection detection" or "CH□ Conversion setting value for disconnection detection" is made valid.</p> <p>(2) When this signal turns on, the Disconnection Detection Flag (XC) and Warning Output Signal (XD) turn off.</p> <p>(3) For the on/off timing, refer to the field of the Operation Condition Setting Completed Signal (X9).</p>
YA	User Range Write Request	<p>[In offset/gain setting mode]</p> <p>(1) This turns ON when the value for the adjusted offset/gain settings are registered in E²PROM.</p> <p>(2) See the XA column for ON/OFF timing. See Section 4.6 for offset/gain settings.</p> <p>[In normal mode]</p> <p>(1) This signal turns ON when the user range is restored.</p> <p>(2) Refer to the field of XA for the ON/OFF timing. Refer to Chapter 7 for user range restoration.</p>
YF	Error Clear Request	<p>(1) This signal is turned on when the Error Flag (XF) and Disconnection Detection Flag (XC) are cleared. However, the set value error of the intelligent function module switch setting cannot be cleared. Correct the set value.</p> <p>(2) For the on/off timing, refer to the field of the Error Flag (XF).</p>

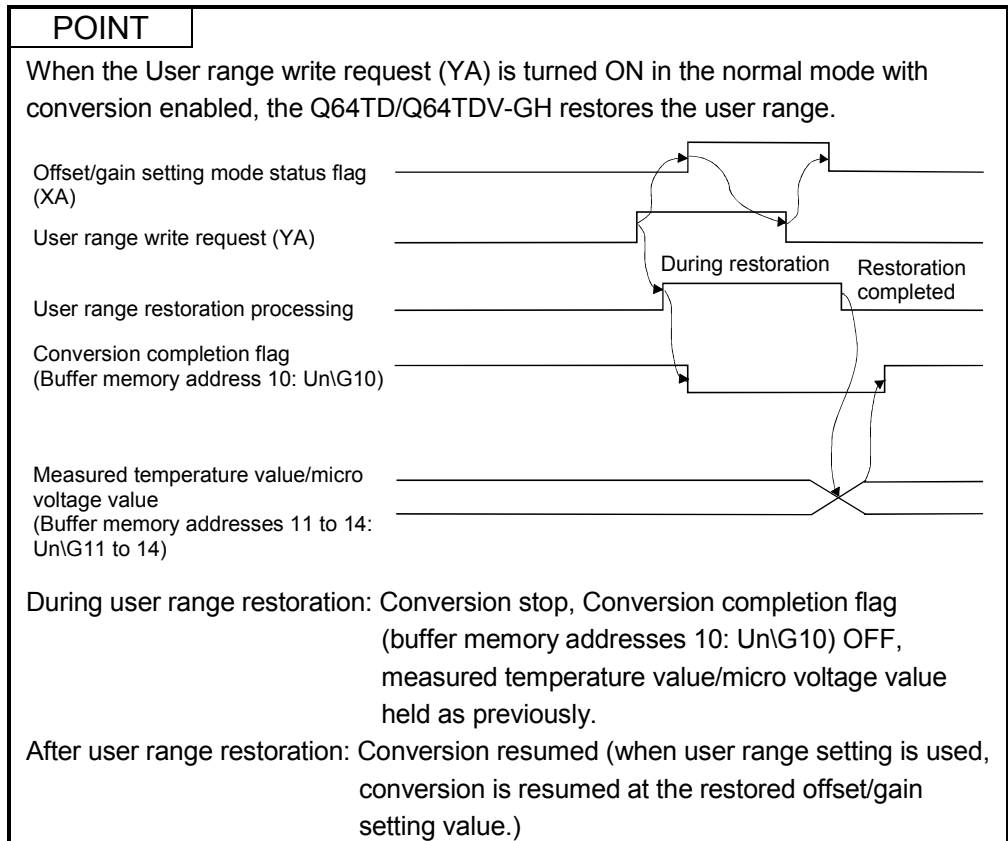

3.4 Buffer Memory

3.4.1 Buffer memory assignment (Q64TD)

This section describes the assignment of the Q64TD buffer memory.

POINT

Do not write data from system area or sequence program to the buffer memory area where writing is disabled. Doing so may cause malfunction.

Table 3.1 Buffer memory assignment (Q64TD) (1/2)

Addresses		Description	R/W * 1	Addresses		Description	R/W * 1
Hex.	Dec.			Hex.	Dec.		
01 H	0	Conversion enable/disable setting	R/W * 2	40 H	64	CH2 scaling range lower limit value	R/W * 2
02 H	1	CH1 time/count averaging setting	R/W * 2	41 H	65	CH2 scaling range upper limit value	R/W * 2
03 H	2	CH2 time/count averaging setting	R/W * 2	42 H	66	CH3 scaling range lower limit value	R/W * 2
04 H	3	CH3 time/count averaging setting	R/W * 2	43 H	67	CH3 scaling range upper limit value	R/W * 2
05 H	4	CH4 time/count averaging setting	R/W * 2	44 H	68	CH4 scaling range lower limit value	R/W * 2
06 H	5	System area	—	45 H	69	CH4 scaling range upper limit value	R/W * 2
to	to			46 H	70	System area	—
08 H	8			to	to		
09 H	9			Averaging processing specification	R/W * 2		
0A H	10	Conversion completion flag	R	4E H	78	CH1 scaling width lower limit value	R/W * 2
0B H	11	CH1 measured temperature value	R	4F H	79	CH1 scaling width upper limit value	R/W * 2
0C H	12	CH2 measured temperature value	R	50 H	80	CH2 scaling width lower limit value	R/W * 2
0D H	13	CH3 measured temperature value	R	51 H	81	CH2 scaling width upper limit value	R/W * 2
0E H	14	CH4 measured temperature value	R	52 H	82	CH3 scaling width lower limit value	R/W * 2
0F H	15	System area	—	53 H	83	CH3 scaling width upper limit value	R/W * 2
to	to			54 H	84	CH4 scaling width lower limit value	R/W * 2
12 H	18			55 H	85	CH4 scaling width upper limit value	R/W * 2
13 H	19	Error code	R	56 H	86	CH1 warning output lower lower limit value	R/W * 2
14 H	20	Setting range	R	57 H	87	CH1 warning output lower upper limit value	R/W * 2
15 H	21	System area	—	58 H	88	CH1 warning output upper lower limit value	R/W * 2
to	to			59 H	89	CH1 warning output upper upper limit value	R/W * 2
2E H	46			5A H	90	CH2 warning output lower lower limit value	R/W * 2
2F H	47			Warning output enable/disable setting	R/W * 2	5B H	91
30 H	48	Warning output flag	R	5C H	92	CH2 warning output upper lower limit value	R/W * 2
31 H	49	Disconnection detection flag	R	5D H	93	CH2 warning output upper upper limit value	R/W * 2
32 H	50	CH1 scaling value	R	5E H	94	CH3 warning output lower lower limit value	R/W * 2
33 H	51	CH2 scaling value	R	5F H	95	CH3 warning output lower upper limit value	R/W * 2
34 H	52	CH3 scaling value	R	60 H	96	CH3 warning output upper lower limit value	R/W * 2
35 H	53	CH4 scaling value	R	61 H	97	CH3 warning output upper upper limit value	R/W * 2
36 H	54	System area	—				
to	to						
3D H	61						
3E H	62	CH1 scaling range lower limit value	R/W * 2				
3F H	63	CH1 scaling range upper limit value	R/W * 2				

Table 3.1 Buffer memory assignment (Q64TD) (2/2)

Addresses		Description	RW * 1	Addresses		Description	RW * 1
Hex.	Dec.			Hex.	Dec.		
62 H	98	CH4 warning output lower lower limit value	R/W * 2	A3 H	163	CH1 user range settings gain value * 3	R/W
63 H	99	CH4 warning output lower upper limit value	R/W * 2	A4 H	164	CH1 user range settings offset value * 3 (L) (H)	R/W
64 H	100	CH4 warning output upper lower limit value	R/W * 2	A5 H	165		
65 H	101	CH4 warning output upper upper limit value	R/W * 2	A6 H	166	CH1 user range settings gain value * 3 (L) (H)	R/W
66 H	102	System area	—	A7 H	167		
to	to			A8 H	168	CH2 factory default offset value * 3	R/W
75 H	117			A9 H	169	CH2 factory default gain value * 3	R/W
76 H	118			CH1 offset temperature set value	R/W * 2	AA H	170
77 H	119	CH1 gain temperature set value	R/W * 2	AB H	171	CH2 user range settings gain value * 3	R/W
78 H	120	CH2 offset temperature set value	R/W * 2	AC H	172	CH2 user range settings offset value * 3 (L) (H)	R/W
79 H	121	CH2 gain temperature set value	R/W * 2	AD H	173		
7A H	122	CH3 offset temperature set value	R/W * 2	AE H	174	CH2 user range settings gain value * 3 (L) (H)	R/W
7B H	123	CH3 gain temperature set value	R/W * 2	AF H	175		
7C H	124	CH4 offset temperature set value	R/W * 2	B0 H	176	CH3 factory default offset value * 3	R/W
7D H	125	CH4 gain temperature set value	R/W * 2	B1 H	177	CH3 factory default gain value * 3	R/W
7E H	126	System area	—	B2 H	178	CH3 user range settings offset value * 3	R/W
to	to			B3 H	179	CH3 user range settings gain value * 3	R/W
93 H	147			B4 H	180	CH3 user range settings offset value * 3 (L) (H)	R/W
94 H	148			Conversion setting for disconnection detection	R/W * 2		
95 H	149	System area	—	B6 H	182	CH3 user range settings gain value * 3 (L) (H)	R/W
96 H	150	CH1 Conversion setting for disconnection detection	R/W * 2	B7 H	183		
97 H	151	CH2 Conversion setting for disconnection detection	R/W * 2	B8 H	184	CH4 factory default offset value * 3	R/W
98 H	152	CH3 Conversion setting for disconnection detection	R/W * 2	B9 H	185	CH4 factory default gain value * 3	R/W
99 H	153	CH4 Conversion setting for disconnection detection	R/W * 2	BA H	186	CH4 user range settings offset value * 3	R/W
9A H	154	System area	—	BB H	187	CH4 user range settings gain value * 3	R/W
to	to			BC H	188	CH4 user range settings offset value * 3 (L) (H)	R/W
9D H	157			BD H	189		
9E H	158			Mode switching setting	R/W	BE H	190
9F H	159	to	to	BF H	191		
A0 H	160	CH1 factory default offset value * 3	R/W	C0 H	192	System area	—
A1 H	161	CH1 factory default gain value * 3	R/W	to	to		
A2 H	162	CH1 user range settings offset value * 3	R/W				

*1 Indicates whether reading from and writing to a sequence program are enabled.

R : Read enabled W : Write enabled

*2 Data must be written to buffer memory under the interlock conditions (buffer memory write conditions) of the following I/O signals.

• Operation condition setting



• Offset setting



• Gain setting



*3 This area is related with the user range save/restore function and allows users to re-set the offset/gain values easily in the case of online module change.

3.4.2 Buffer memory assignment (Q64TDV-GH)

The assignment of the Q64TDV-GH buffer memory will be explained.

POINT
Do not write data from system area or sequence program to the buffer memory area where writing is disabled. Doing so may cause malfunction.

Table 3.2 Buffer memory assignment (Q64TDV-GH) (1/2)

Addresses		Description	R/W * 1	Addresses		Description	R/W * 1
Hex.	Dec.			Hex.	Dec.		
00 H	0	Conversion enable/disable setting	R/W * 2	46 H	70	System area	—
01 H	1	CH1 time/count averaging setting	R/W * 2	to	to		
02 H	2	CH2 time/count averaging setting	R/W * 2	4D H	77		
03 H	3	CH3 time/count averaging setting	R/W * 2	4E H	78	CH1 scaling width lower limit value	R/W * 2
04 H	4	CH4 time/count averaging setting	R/W * 2	4F H	79	CH1 scaling width upper limit value	R/W * 2
05 H	5	System area	—	50 H	80	CH2 scaling width lower limit value	R/W * 2
to	to			51 H	81	CH2 scaling width upper limit value	R/W * 2
08 H	8			52 H	82	CH3 scaling width lower limit value	R/W * 2
09 H	9			Averaging processing specification	R/W * 2	53 H	83
0A H	10	Conversion completion flag	R	54 H	84	CH4 scaling width lower limit value	R/W * 2
0B H	11	CH1 measured temperature value/micro voltage conversion value	R	55 H	85	CH4 scaling width upper limit value	R/W * 2
0C H	12	CH2 measured temperature value/micro voltage conversion value	R	56 H	86	CH1 warning output lower lower limit value	R/W * 2
0D H	13	CH3 measured temperature value/micro voltage conversion value	R	57 H	87	CH1 warning output lower upper limit value	R/W * 2
0E H	14	CH4 measured temperature value/micro voltage conversion value	R	58 H	88	CH1 warning output upper lower limit value	R/W * 2
0F H	15	System area	—	59 H	89	CH1 warning output upper upper limit value	R/W * 2
to	to			5A H	90	CH2 warning output lower lower limit value	R/W * 2
12 H	18			13 H	19	Error code	R
14 H	20	Setting range 1	R	5B H	91	CH2 warning output lower upper limit value	R/W * 2
15 H	21	Setting range 2	R	5C H	92	CH2 warning output upper lower limit value	R/W * 2
16 H	22	System area	—	5D H	93	CH2 warning output upper upper limit value	R/W * 2
to	to			5E H	94	CH3 warning output lower lower limit value	R/W * 2
2E H	46			2F H	47	Warning output enable/disable setting	R/W * 2
30 H	48	Warning output flag	R	5F H	95	CH3 warning output lower upper limit value	R/W * 2
31 H	49	Disconnection detection flag	R	60 H	96	CH3 warning output upper lower limit value	R/W * 2
32 H	50	CH1 scaling value	R	61 H	97	CH3 warning output upper upper limit value	R/W * 2
33 H	51	CH2 scaling value	R	62 H	98	CH4 warning output lower lower limit value	R/W * 2
34 H	52	CH3 scaling value	R	63 H	99	CH4 warning output lower upper limit value	R/W * 2
35 H	53	CH4 scaling value	R	64 H	100	CH4 warning output upper lower limit value	R/W * 2
36 H	54	System area	—	65 H	101	CH4 warning output upper upper limit value	R/W * 2
to	to			66 H	102	System area	—
3D H	61			3E H	62		
3E H	62	CH1 scaling range lower limit value	R/W * 2	to	to		
3F H	63	CH1 scaling range upper limit value	R/W * 2	75 H	117		
40 H	64	CH2 scaling range lower limit value	R/W * 2				
41 H	65	CH2 scaling range upper limit value	R/W * 2				
42 H	66	CH3 scaling range lower limit value	R/W * 2				
43 H	67	CH3 scaling range upper limit value	R/W * 2				
44 H	68	CH4 scaling range lower limit value	R/W * 2				
45 H	69	CH4 scaling range upper limit value	R/W * 2				

Table 3.2 Buffer memory assignment (Q64TDV-GH) (2/2)

Addresses		Description	RW * 1	Addresses		Description	RW * 1
Hex.	Dec.			Hex.	Dec.		
76 H	118	CH1 offset setting value	R/W * 2	A4 H	164	CH1 user range settings thermal EMF (L)	R/W
77 H	119	CH1 gain setting value	R/W * 2	A5 H	165	offset value * 3 (H)	
78 H	120	CH2 offset setting value	R/W * 2	A6 H	166	CH1 user range settings thermal EMF (L)	R/W
79 H	121	CH2 gain setting value	R/W * 2	A7 H	167	gain value * 3 (H)	
7A H	122	CH3 offset setting value	R/W * 2	A8 H	168	CH2 factory default offset value * 3	R/W
7B H	123	CH3 gain setting value	R/W * 2	A9 H	169	CH2 factory default gain value * 3	R/W
7C H	124	CH4 offset setting value	R/W * 2	AA H	170	CH2 user range settings offset value * 3	R/W
7D H	125	CH4 gain setting value	R/W * 2	AB H	171	CH2 user range settings gain value * 3	R/W
7E H	126	System area	—	AC H	172	CH2 user range settings thermal EMF (L)	R/W
to	to			AD H	173	offset value * 3 (H)	
93 H	147			AE H	174	CH2 user range settings thermal EMF (L)	R/W
94 H	148	AF H	175	gain value * 3 (H)			
95 H	149	Conversion setting for disconnection detection	R/W * 2	B0 H	176	CH3 factory default offset value * 3	R/W
96 H	150	System area	—	B1 H	177	CH3 factory default gain value * 3	R/W
96 H	150	CH1 Conversion setting for disconnection detection	R/W * 2	B2 H	178	CH3 user range settings offset value * 3	R/W
97 H	151	CH2 Conversion setting for disconnection detection	R/W * 2	B3 H	179	CH3 user range settings thermal EMF gain value * 3	R/W
98 H	152	CH3 Conversion setting for disconnection detection	R/W * 2	B4 H	180	CH3 user range settings thermal EMF (L)	R/W
99 H	153	CH4 Conversion setting for disconnection detection	R/W * 2	B5 H	181	offset value * 3 (H)	
9A H	154	System area	—	B6 H	182	CH3 user range settings gain value * 3 (L)	R/W
to	to			B7 H	183	offset value * 3 (H)	
93 H	147			B8 H	184	CH4 factory default offset value * 3	R/W
94 H	148	Conversion setting for disconnection detection	R/W * 2	B9 H	185	CH4 factory default gain value * #	R/W
95 H	149	System area	—	BA H	186	CH4 user range settings offset value * 3	R/W
96 H	150	CH1 Conversion setting value for disconnection detection	R/W * 2	BB H	187	CH4 user range settings gain value * #	R/W
97 H	151	CH2 Conversion setting value for disconnection detection	R/W * 2	BC H	188	CH4 user range settings thermal EMF (L)	R/W
98 H	152	CH3 Conversion setting value for disconnection detection	R/W * 2	BD H	189	offset value * 3 (H)	
99 H	153	CH4 Conversion setting value for disconnection detection	R/W * 2	BE H	190	CH4 user range settings thermal EMF (L)	R/W
9A H	154	System area	—	BF H	191	gain value * 3 (H)	
to	to			C0 H	192	System area	—
9D H	157			to	to		
9E H	158	Mode switching setting	R/W				
9F H	159						
A0 H	160	CH1 factory default offset value * 3	R/W				
A1 H	161	CH1 factory default gain value * 3	R/W				
A2 H	162	CH1 user range settings offset value * 3	R/W				
A3 H	163	CH1 user range settings gain value * 3	R/W				

*1 Indicates whether reading from and writing to a sequence program are enabled.
 R : Read enabled W : Write enabled

*2 Data must be written to buffer memory under the interlock conditions (buffer memory write conditions) of the following I/O signals.

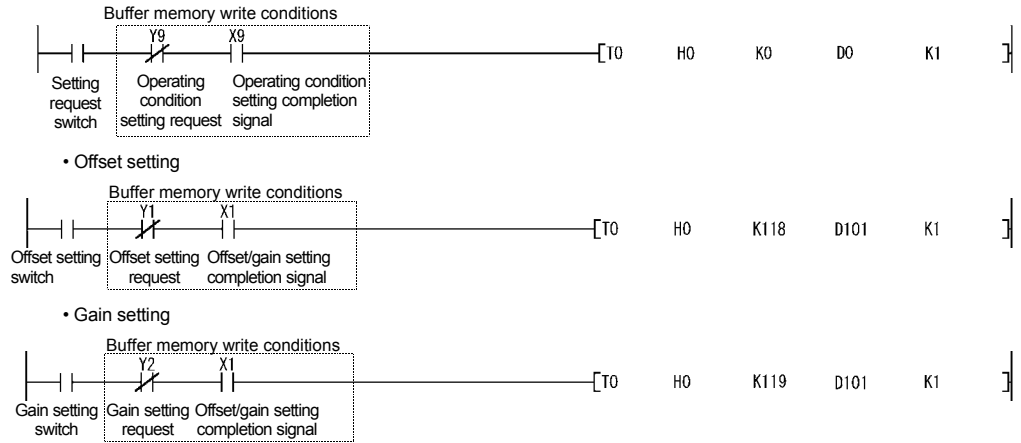

*3 This area is related with the user range save/restore function and allows users to re-set the offset/gain values easily in the case of online module change.

3.4.3 Conversion enable/disable setting (Un\G0)

- (1) You can make setting to enable/disable temperature conversion on each channel.
- (2) Specifying unused channels as "conversion disabled" prevents unnecessary disconnection detection and also reduces sampling time.
- (3) At power-on or reset, the conversion enable/disable setting is set to 000FH (all channels disabled).

b15	b14	b13	b12	b11	b10	b9	b8	b7	b6	b5	b4	b3	b2	b1	b0
0	0	0	0	0	0	0	0	0	0	0	0	CH4	CH3	CH2	CH1

0: Conversion enabled
1: Conversion disabled

[Example]

b15	b14	b13	b12	b11	b10	b9	b8	b7	b6	b5	b4	b3	b2	b1	b0
0	0	0	0	0	0	0	0	0	0	0	0	1	1	0	0

Channels 1 and 2 are conversion enabled.

- (4) The Operating Condition Setting Request (Y9) must be turned on/off to make the conversion enable/disable setting valid.

3.4.4 CH □ time/count averaging setting (Un\G1 to 4)

- (1) Set the averaging time or averaging count for each channel when averaging processing is selected. (buffer memory address 9: Un\G9).
- (2) Setting can be made within the following ranges.
 Time averaging processing: 160 to 5000ms (Q64TD)
 80 to 2500ms (Q64TDV-GH)
 Count averaging processing: 4 to 62500 times
 If you set any value outside the range, it will result in an error and the previous setting will not be updated.
- (3) This setting will be invalid if sampling is specified in the averaging processing specification (buffer memory address 9: Un\G9).
- (4) At power-on or reset, this area is set to 0000H (averaging time 0/averaging count 0).
- (5) The Operating Condition Setting Request (Y9) must be turned on/off to make this setting valid.
- (6) Refer to Section 3.4.5 for details of sampling processing/time averaging processing/count averaging processing.

3.4.5 Averaging processing specification (Un\G9)

- (1) To select sampling or averaging processing, write values to the buffer memory address 9 (Un\G9).
- (2) When you selected averaging processing, choose time averaging or count averaging.
- (3) The default is set to sampling processing for all channels.

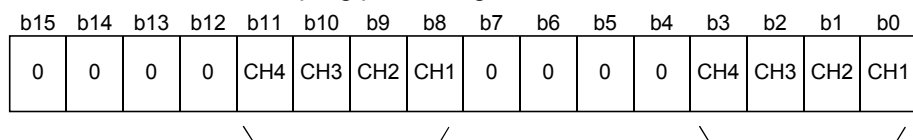

Setting of channels
 1: Averaging processing
 0: Sampling processing

Selection of time/count
 1: Time averaging
 0: Count averaging

- (4) The Operating Condition Setting Request (Y9) must be turned on/off to make this setting valid.

Example

To specify count averaging for channels 1, time averaging for channels 2 and sampling processing for other channels, store 0302H (770) into the buffer memory address 9 (Un\G9).

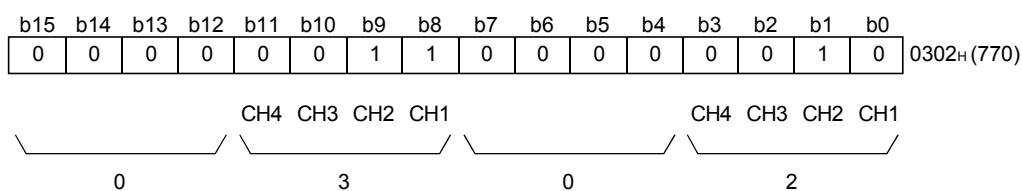

3.4.6 Conversion completion flag (Un\G10)

- (1) You can check whether the channels specified for conversion enable succeeded in normal conversion.
- (2) You can make check on each channel using the conversion completion flag.
- (3) The conversion completion flag is cleared when the Operating Condition Setting Request (Y9) is turned from ON to OFF.
- (4) The Conversion Completion Flag (XE) turns on when conversions of all conversion-enabled channels are completed.
 - When conversion enable/disable setting is turned from 1 (disable) to 0 (enable)
After the measured temperature value/micro voltage conversion voltage is stored into the buffer memory, the conversion completion flag of the corresponding channel is turned to 1.
 - When the conversion enable/disable setting is turned from 0 (enable) to 1 (disable)
The conversion completion flag of the corresponding channel is turned to 0.

b15	b14	b13	b12	b11	b10	b9	b8	b7	b6	b5	b4	b3	b2	b1	b0
0	0	0	0	0	0	0	0	0	0	0	0	CH4	CH3	CH2	CH1

1: Conversion completed
0: During conversion or unused

REMARK

Between the Q64TD/Q64TDV-GH whose first 5 digits of product information are 07071 or earlier and those of 07072 or later, the Conversion Completion Flag (Un\G10) operation is different.
For details, refer to Appendix 4.2.

3.4.7 CH □ measured temperature value/micro voltage value (Un\G11 to 14)

(1) Thermocouple input

- (a) The "thermal EMF value" input from the thermocouple is converted into a "temperature value" to detect a temperature.
- (b) The value of the measured temperature to the first decimal place is multiplied by 10 and the result is stored into buffer memory in 16-bit signed binary. (The second decimal place and on are rounded down.)
- (c) A negative measured temperature value is displayed as two's complement.
- (d) At power-on or reset, all channels are set to 0.

[Example 1] At the measured temperature value of 123.025°C 1230 is stored.

b15	b14	b13	b12	b11	b10	b9	b8	b7	b6	b5	b4	b3	b2	b1	b0
0	0	0	0	0	1	0	0	1	1	0	0	1	1	1	0

[Example 2] At the measured temperature value of -123.025°C -1230 is stored.

b15	b14	b13	b12	b11	b10	b9	b8	b7	b6	b5	b4	b3	b2	b1	b0
1	1	1	1	1	0	1	1	0	0	1	1	0	0	1	0

(2) Micro voltage input

- (a) A micro voltage of -100mV to +100mV is converted into a 16-bit, signed binary value of -25000 to 25000, and the result is stored.
- (b) A negative micro voltage conversion value is displayed as two's complement.
- (c) At power-on or reset, all channels are set to 0.

[Example 1] At the micro voltage input value of 51.300mV 12825 is stored.

b15	b14	b13	b12	b11	b10	b9	b8	b7	b6	b5	b4	b3	b2	b1	b0
0	0	1	1	0	0	1	0	0	0	0	1	1	0	0	1

[Example 2] At the micro voltage input value of -51.300mV -12825 is stored.

b15	b14	b13	b12	b11	b10	b9	b8	b7	b6	b5	b4	b3	b2	b1	b0
1	1	0	0	1	1	0	1	1	1	1	0	0	1	1	1

3.4.8 Error code (Un\G19)

- (1) When the Q64TD/Q64TDV-GH has detected a set value or operation procedure error, the corresponding error code is stored.
- (2) The error code is stored as a 16-bit binary value.
- (3) When an error occurs, the "ERROR LED" of the Q64TD/Q64TDV-GH is lit.
- (4) The following are main checking details.

Timing	Description
At start	<ul style="list-style-type: none"> • Check on the intelligent function module switch settings of GX Developer
When Operating Condition Setting Request (Y9) has turned from ON to OFF	<ul style="list-style-type: none"> • Check on averaging processing specification • Check on averaging time and averaging count • Check on warning output upper/upper limit values
When Offset Setting Request (Y1, Y3, Y5, Y7) or Gain Setting Request (Y2, Y4, Y6, Y8) is turned on	<ul style="list-style-type: none"> • Check on offset/gain setting • Check on preset CH <input type="checkbox"/> offset temperature value/CH <input type="checkbox"/> gain temperature value • Check whether Offset Setting Request (Y1, Y3, Y5, Y7) and Gain Setting Request (Y2, Y4, Y6, Y8) are not turned on at the same time.
When User Range Write Request (YA) has turned from ON to OFF*	<ul style="list-style-type: none"> • Check whether the same data was written consecutively or not. • Check whether the pass data has been set or not.
When G(P).OGSTOR instruction is executed in sequence program*	<ul style="list-style-type: none"> • Check whether the same data was written consecutively or not. • Check whether a different model has been mounted or not by an online module change.

* Supported by the module of function version C or later.

- (5) When two or more errors occurred, the error code of the error found first is stored and latter errors are not stored. However, you can confirm the latter errors in the error history of the detailed module information of GX Developer.
- (6) Giving the Error Clear Request (YF) clears the error code and turns off the lit "ERROR LED".
- (7) Clearing the error stores 0.

3.4.9 Setting range (Q64TD) (Un\G20)

- (1) The settings of the "thermocouple type" and "offset/gain setting" are stored.
- (2) Use the intelligent function module switches of GX Developer to make settings of the "thermocouple type" and "offset/gain setting".
Refer to Section 4.5 for details of the setting method.

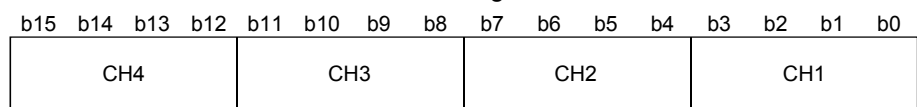

Set value of offset/gain setting	
Offset/Gain Setting	Set Value
Factory default	0
User range setting	1

Set value of thermocouple type	
Thermocouple Type	Set Value
K	0
E	1
J	2
T	3
B	4
R	5
S	6
N	7

3.4.10 Setting range 1 (Q64TDV-GH) (Un\G20)

- (1) The setting of the "input type" is stored.
- (2) Use the intelligent function module switches of GX Developer to make the setting of the "input type".

Refer to Section 4.5 for details of the setting method.

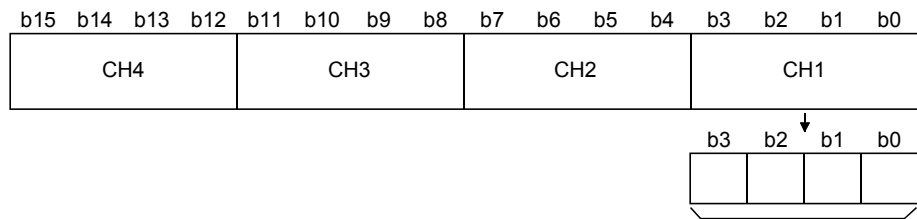

Set value of input type

Input Type	Set Value
Thermocouple K	0
Thermocouple E	1
Thermocouple J	2
Thermocouple T	3
Thermocouple B	4
Thermocouple R	5
Thermocouple S	6
Thermocouple N	7
Micro voltage input	8

3.4.11 Setting range 2 (Q64TDV-GH) (Un\G21)

- (1) The setting of the "offset/gain setting" is stored.
- (2) Use the intelligent function module switches of GX Developer to make the setting of the "offset/gain setting".

Refer to Section 4.5 for details of the setting method.

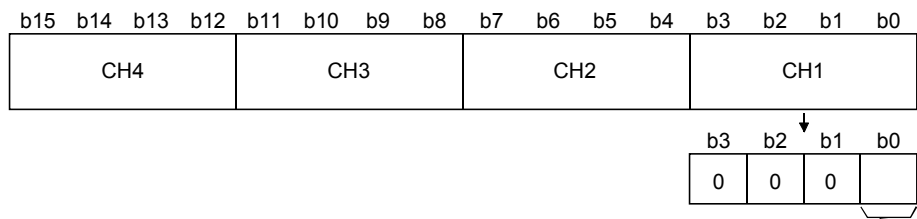

Set value of offset/gain setting

Offset/Gain Setting	Set Value
Factory default	0
User range setting	1

3.4.12 Warning output enable/disable setting (Un\G47)

- (1) This area is used to set whether a warning will be output or not per channel.
- (2) At power-on or reset, the warning output enable/disable setting is set to 000FH (all channels disabled).

b15	b14	b13	b12	b11	b10	b9	b8	b7	b6	b5	b4	b3	b2	b1	b0
0	0	0	0	0	0	0	0	0	0	0	0	CH4	CH3	CH2	CH1

0: Warning output enable
1: Warning output disable

[Example]

b15	b14	b13	b12	b11	b10	b9	b8	b7	b6	b5	b4	b3	b2	b1	b0
0	0	0	0	0	0	0	0	0	0	0	0	1	1	0	0

Channels 1 and 2 are warning output enabled.

- (3) The Operating Condition Setting Request (Y9) must be turned on/off to make the warning output enable/disable setting valid.

3.4.13 Warning output flag (Un\G48)

- (1) When a temperature/micro voltage detected is outside the range set for the CH□ warning output upper/lower limit value (buffer memory addresses 86 to 101: Un\G86 to 101), the warning output flag of the corresponding channel turns to 1.
- (2) You can check whether the warning given is the upper or lower limit value warning on each channel.
- (3) When the measured temperature value/micro voltage conversion value returned to within the measurement range, the flag is automatically reset.
- (4) If a warning is detected on any of the channels enabled for conversion, the Warning Output Signal (XD) turns on.
- (5) The warning output flag is cleared when the Operation Condition Setting Request (Y9) is turned on.

b15	b14	b13	b12	b11	b10	b9	b8	b7	b6	b5	b4	b3	b2	b1	b0
0	0	0	0	0	0	0	0	CH4 upper limit value	CH4 lower limit value	CH3 upper limit value	CH3 lower limit value	CH2 upper limit value	CH2 lower limit value	CH1 upper limit value	CH1 lower limit value

0: Normal
1: Out-of-range

POINT
Refer to Section 3.4.18 for details of the warning output.

3.4.14 Disconnection detection flag (Un\G49)

- (1) The disconnection detection flag of the corresponding channel turns to 1 when the disconnection of the thermocouple, compensation conductor or micro voltage signal cable is detected.
- (2) Disconnection detection is made on only the channels set for conversion enable.
- (3) Disconnection is detected on each channel.
- (4) For a channel where disconnection is detected, a value based on the Conversion setting for disconnection detection (buffer memory address 148: Un\G148) is stored in the CH□ measured temperature value/micro voltage value (buffer memory addresses 11 to 14: Un\G11 to 14).

Conversion of the channels not disconnected is continued.

b15	b14	b13	b12	b11	b10	b9	b8	b7	b6	b5	b4	b3	b2	b1	b0
0	0	0	0	0	0	0	0	0	0	0	0	CH4	CH3	CH2	CH1

0: Normal
1: Disconnection

- (5) The disconnection detection flag is cleared when the Operation Condition Setting Request (Y9) or Error Clear Request (YF) is turned on. Clearing of the disconnection detection flag using the Error Clear Request (YF) is supported by the module of function version C or later.
- (6) The relationships between disconnection detection and conversion enable/disable setting are indicated below.

Connection Status	Conversion Enable/Disable Setting	Disconnection Detection Flag
<p>Without disconnection</p>	Conversion enable	OFF
	Conversion disable	
<p>With disconnection</p>	Conversion enable	ON
	Conversion disable	OFF
<p>Without connection</p>	Conversion enable	ON
	Conversion disable	OFF

POINT

- Any channel where no thermocouple, compensation conductor or micro voltage signal cable is connected must be set to "conversion disable". Not doing so will turn on the disconnection detection flag.
- For temperature conversion values to be stored when the Disconnection Detection Flag (XC) turns ON, any of "Value immediately before disconnection", "Up scale (maximum value of measured temperature range + 5% of measured temperature range)", "Down scale (minimum value of measured temperature range - 5% of measured temperature range)" or "Given value" can be selected. (Refer to Section 3.2.4.)
- Refer to Section 4.4 for the wiring of the thermocouple, compensation conductor or micro voltage signal cable.
- Refer to Section 8.2.5 for the troubleshooting of disconnection detection.

3.4.15 CH □ scaling value (Un\G50 to 53)

- (1) The measured temperature value/micro voltage conversion value within the scaling range set for the CH □ scaling range upper/lower limit values (buffer memory address 62 to 69: Un\G62 to 69) is scaled to the scaling width set for the CH □ scaling width upper/lower limit values (buffer memory address 78 to 85: Un\G78 to 85) and the result is stored.
- (2) The following is how to calculate the scaling value.

$$\text{Scaling value} = \frac{(\text{Scaling width upper limit value} - \text{Scaling width lower limit value}) \times \text{Measured temperature value} / \text{micro voltage conversion value} - \text{Scaling range lower limit value}}{\text{Scaling range upper limit value} - \text{Scaling range lower limit value}} = \text{Scaling width lower limit value}$$

[Example]

To scale a temperature to a percent

When the CH1 measured temperature value of 360°C (measured temperature value = 3600) is scaled at the following settings,

Scaling range: -100 to 500°C (lower limit value = -1000, upper limit value = 5000)

Scaling width: 0 to 100% (lower limit value = 0, upper limit value = 100)

$$\text{Scaling value} = (100-0) \times \frac{3600 - (-1000)}{5000 - (-1000)} + 0 = 76.666666 \dots$$

Fractional portion is rounded off.

$$= 77[\%]$$

Stored into buffer memory address 50.

POINT

- (1) If the upper limit value is less than the lower limit value in the settings of the CH □ scaling range upper/lower limit values (buffer memory address 62 to 69: Un\G62 to 69) or CH □ scaling width upper/lower limit values (buffer memory address 78 to 85: Un\G78 to 85), it will not result in an error and the scaling value will be output using the above calculation expression to make calculation.
- (2) If the temperature/micro voltage measured is outside the range set by the upper and lower limit values of the scaling range, the value set as the upper or lower limit value of the scaling width is stored into the buffer memory.

3.4.16 CH □ scaling range upper/lower limit values (Un\G62 to 69)

- (1) Set the scaling range of the temperature measurement value/micro voltage conversion value on each channel.
The setting for the measured temperature value is in 0.1°C increments.
- (2) 0 is set at power-on or reset.
- (3) The scaling range that may be set is -32768 to 32767.
- (4) Scaling will not be made if the upper limit value and lower limit value are equal.
- (5) The Operating Condition Setting Request (Y9) must be turned on/off to make the setting valid.

3.4.17 CH □ scaling width upper/lower limit values (Un\G78 to 85)

- (1) Set the scaling width on each channel.
- (2) 0 is set at power-on or reset.
- (3) The scaling range that may be set is -32768 to 32767.
- (4) Set the upper and lower limit values to 0 when scaling will not be made.
- (5) The Operating Condition Setting Request (Y9) must be turned on/off to make the setting valid.

3.4.18 CH □ warning output upper/lower limit values (Un\G86 to 101)

- (1) Set the warning output range of the measured temperature value/micro voltage conversion value on each channel.
The setting for the measured temperature value is in 0.1°C increments.
- (2) The warning output range can be set in four levels of the warning output upper upper value, upper lower value, lower upper value and lower lower value.
- (3) When the detected measured temperature value is higher than or equal to the warning output upper upper limit value, or lower than or equal to the warning output lower lower limit value (when the value enters the warning output range), a warning occurs.
When a warning occurs, "1" is stored to the bit of the corresponding channel in the warning output flag (buffer memory address 48: Un\G48), and the warning output signal (XD) turns ON.
- (4) After a warning occurrence, when the temperature value is lower than the warning output upper lower limit value or higher than the warning output lower upper limit value (when the value returns to within the setting range), the warning is cleared.
When the warning is cleared, "0" is stored to the bit of the corresponding channel in the warning output flag (buffer memory address 48: Un\G48).
The warning output signal (XD) turns OFF only when the values for all channels return to within the setting range.

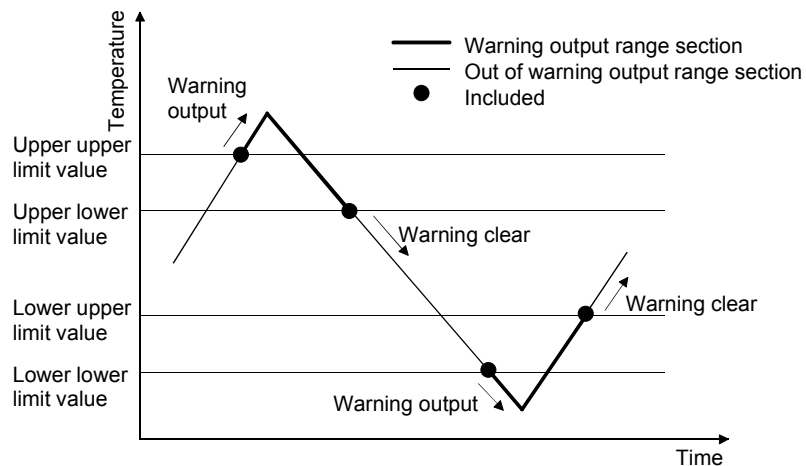

- (5) At power-on or reset, the minimum and maximum values of the accuracy guarantee range of the input type set as the input type (set using GX Developer) are stored.

The upper upper limit value is set to be equal to the upper lower limit value, and the lower upper limit value equal to the lower lower limit value.

Input type	Settings at Power-On or Reset				Available Temperature Range(Accuracy guarantee range)
	Lower upper limit value	Lower lower limit value	Upper upper limit value	Upper lower limit value	
Thermocouple K	-2000		12000		-2700 to 13700 (-2000 to 12000)
Thermocouple E	-2000		9000		-2700 to 10000 (-2000 to 9000)
Thermocouple J	-400		7500		-2100 to 12000 (-400 to 7500)
Thermocouple T	-2000		3500		-2700 to 4000 (-2000 to 3500)
Thermocouple B	6000		17000		0 to 18200 (-6000 to 17000)
Thermocouple R	0		1600		-500 to 17600 (-0 to 1600)
Thermocouple S	0		1600		-500 to 17600 (-0 to 1600)
Thermocouple N	-2000		12500		-2700 to 13000 (-2000 to 12500)
Micro voltage input	-2500		25000		-30000 to 30000 (-25000 to 25000)

- (6) When the settings below are applied, an error (error code 6△□) occurs. Then the error flag (XF) turns ON and the operation is carried out with the setting before the error occurrence.
- (a) Setting a value out of the above settable range.
 - (b) Setting a value that does not satisfy the following condition:
 $\text{Warning output lower lower limit value} \leq \text{lower upper limit value} \leq \text{upper lower limit value} \leq \text{upper upper limit value}$
- (7) If the lower upper limit value is equal to the upper lower limit value, an error does not occur and the warning output is made invalid.
- (8) The Operating Condition Setting Request (Y9) must be turned on/off to make the setting valid.

3.4.19 CH □ offset/gain temperature value (Q64TD)/CH □ offset/gain setting value (Q64TDV-GH) (Un\G118 to 125)

- (1) Offset/gain setting (error compensation) is a function designed to compensate for the value at any two points (offset value/gain value) within the operating range when the proper measured temperature value/micro voltage conversion value is not available at a system start or when the input type is changed.
- (2) When the Offset Setting Request/Gin Setting Request (Y1 to 8) is turned on in the offset/gain setting mode, the measured temperature value/micro voltage conversion value is corrected to be the set value written to this area. (Setting for measured temperature value in 0.1°C increments)
 [Example] To set to 80°C Store 800.
- (3) Error compensation is made by reading the measured temperature value/micro voltage conversion value of the buffer memory using a sequence program and monitoring the values on the peripheral device.
- (4) The following are the relationships between the measured temperature value/micro voltage conversion value and offset value/gain value relative to the input temperature.
 - (a) Thermocouple input

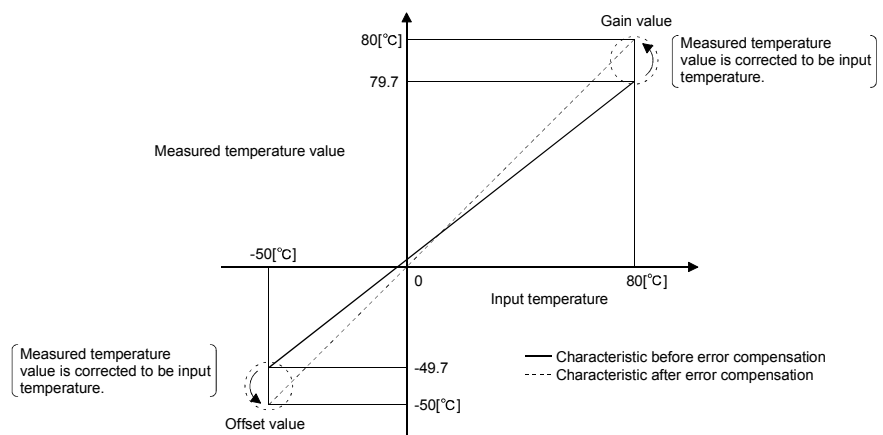

(b) Micro voltage input

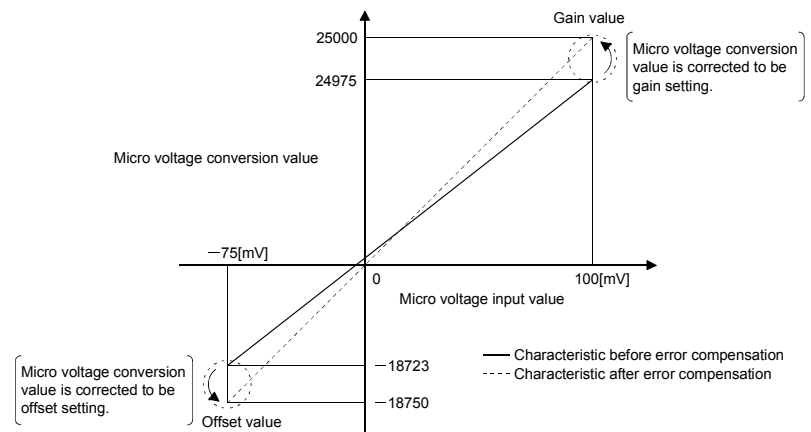

- (5) At power-on or reset, the minimum and maximum values in the accuracy guarantee range of the input type set as Input type (set using GX Developer) are stored.
 Refer to Section 3.4.18 for the accuracy guarantee range.

POINT
<ul style="list-style-type: none"> High accuracy is ensured for the offset and gain values when the minimum and maximum values within the operating range are used to make error compensation. Make offset/gain value setting while simultaneously reading the measured temperature value/micro voltage conversion value. Always set the offset and gain values so that they will satisfy the following conditions. An error will occur if the conditions are not satisfied. Condition 1: Within the input enabled range Condition 2: (Gain value) - (offset value) > 0.1 [°C] (for temperature input) or (Gain value) - (offset value) > 4 [μV] (for micro voltage input) By giving the user range write request, the offset and gain values are stored into the E²PROM of the Q64TD/Q64TDV-GH and will not be erased at power-off. For thermocouple input, error compensation may also be made using a standard DC voltage generator or like instead of inputting a temperature directly to the thermocouple. <div style="display: flex; justify-content: center; align-items: center; margin-top: 10px;"> <div style="border: 1px solid black; padding: 2px 5px; font-size: small;">Power value of standard DC voltage generator</div> = <div style="border: 1px solid black; padding: 2px 5px; font-size: small;">Thermoelectromotive force value of thermocouple used as offset/gain value relative to input temperature</div> </div>

3.4.20 Conversion setting for disconnection detection (Un\G148)

- (1) Select the value to be stored in the CH□ measured temperature value/micro voltage value (buffer memory address 11 to 14: Un\G11 to 14) in the case of disconnection detection.

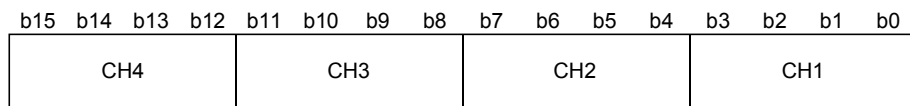

Setting value	Value to be stored in the CH□ measured temperature value in the case of disconnection detection.
0H	Value immediately before disconnection
1H	Up scale (maximum value of measured temperature range + 5% of measured temperature range)
2H	Down scale (minimum value of measured temperature range - 5% of measured temperature range)
3H	Given value (set a value for the CH□ conversion setting for disconnection state value)(refer to Section 3.4.21)

- (2) This is set to 0H (Value immediately before disconnection) when the module is powered up or reset.
- (3) The Operating Condition Setting Request (Y9) must be turned on/off to make the setting valid.
- (4) Do not set any value outside the setting range.
If it is set, the module operation cannot be guaranteed.

3.4.21 Conversion setting value for disconnection detection (Un\G150 to 153)

- (1) If Given value (3H) is set in the Conversion setting for disconnection detection (buffer memory address 148: Un\G148), when disconnection is detected, the value set in this area is stored in the CH□ measured temperature value/micro voltage value (buffer memory addresses 11 to 14: Un\G11 to 14).
If any of 0H to 2H is set in the Conversion setting for disconnection detection, setting of this area is ignored.
- (2) The setting range is from -32768 to 32767 (0000H to FFFFH). (Setting in 0.1°C increments.)
[Example] To set to 0.3°C Store 3.
- (3) This is set to 0 when the module is powered up or reset.
- (4) The Operating Condition Setting Request (Y9) must be turned on/off to make the setting valid.

3.4.22 Mode switching setting (Un\G158 to 159)

Used to change between the normal mode and offset/gain setting mode. You can change the mode without resetting the programmable controller CPU.

- (1) Set the value of the mode to which you want to switch.
- (2) After setting the value, turn the operating condition setting request (Y9) from OFF to ON to shift the mode.
- (3) When the mode is switched, this area is cleared to zero and the operating condition setting completion flag (X9) turns off.
After making sure that the operating condition setting completion flag (X9) has turned off, turn off the operating condition setting request (Y9).

Mode to Be Shifted to	Set Value	
	Buffer memory address 158	Buffer memory address 159
Normal mode	0964H	4144H
Offset/gain setting mode	4144H	0964H

POINT	If the value written is other than the above, mode switching is not performed and only the operating condition is changed.
--------------	--

3.4.23 Factory default offset/gain value/User range settings offset/gain value/User range settings thermal EMF offset/gain value (Un\G160 to 191)

- (1) This area is related with the user range save/restore function and allows users to re-set the offset/gain values easily in the case of online module change.
- (2) When the offset/gain values of the user range setting are restored, the used data are stored.
The data are stored (saved) when:
 - Initial setting write is performed by the utility;
 - The operating condition is set (Y9 turns from OFF to ON * 1)
 - The offset/gain values are written in the offset/gain setting mode (YA turns from OFF to ON).

*1: The data are not saved when values have been written to the mode switching setting area (buffer memory addresses 158, 159: Un\G158, Un\G159).
- (3) When restoring the offset/gain values of the user range setting, set the data saved here similarly into the corresponding area of the module where the data will be restored.
- (4) Buffer memory saving recording procedure for online module change
 - 1) Turn the operating condition setting request (Y9) from OFF to ON.
 - 2) Compare the Factory default offset/gain value/User range settings offset/gain value/User range settings thermal EMF offset/gain value (buffer memory addresses 160 to 191: Un\G160 to Un\G191) with the range reference values. Refer to Section 7.4 for the range reference values.
 - 3) If the values are proper, record the Factory default offset/gain value/User range settings offset/gain value/User range settings thermal EMF offset/gain value.
- (5) Refer to Chapter 7 for details of online module change.

POINT
This area is not used for the offset/gain settings. For the offset/gain settings, refer to section 4.6.

4 SETUP AND PROCEDURES BEFORE OPERATION

4.1 Handling Precautions

- (1) Do not drop the module or subject it to heavy impact.
- (2) Do not remove the PCB of the module from its case. Doing so may cause the module to fail.
- (3) Be careful not to let foreign particles such as swarf or wire chips enter the module. They may cause a fire, mechanical failure or malfunction.
- (4) The top surface of the module is covered with a protective film to prevent foreign objects such as wire burrs from entering the module during wiring. Do not remove this film until the wiring is complete. Before operating the system, be sure to remove the film to provide adequate ventilation.
- (5) Tighten the screws such as module fixing screws within the following ranges. Loose screws may cause short circuits, failures, or malfunctions.

Screw location	Tightening torque range
Module fixing screw (M3 screw) *1	0.36 to 0.48 N·m
Terminal block screw (M3 screw)	0.42 to 0.58 N·m
Terminal block mounting screw (M3.5 screw)	0.66 to 0.89 N·m

* 1: The module can be easily fixed onto the base unit using the hook at the top of the module.

However, it is recommended to secure the module with the module fixing screw if the module is subject to significant vibration.

- (6) To mount the module on the base unit, fully insert the module fixing latch into the fixing hole in the base unit and press the module using the hole as a fulcrum. Improper installation may result in a module malfunction, or may cause the module to fall off.

4.2 Setup and Procedures before Operation

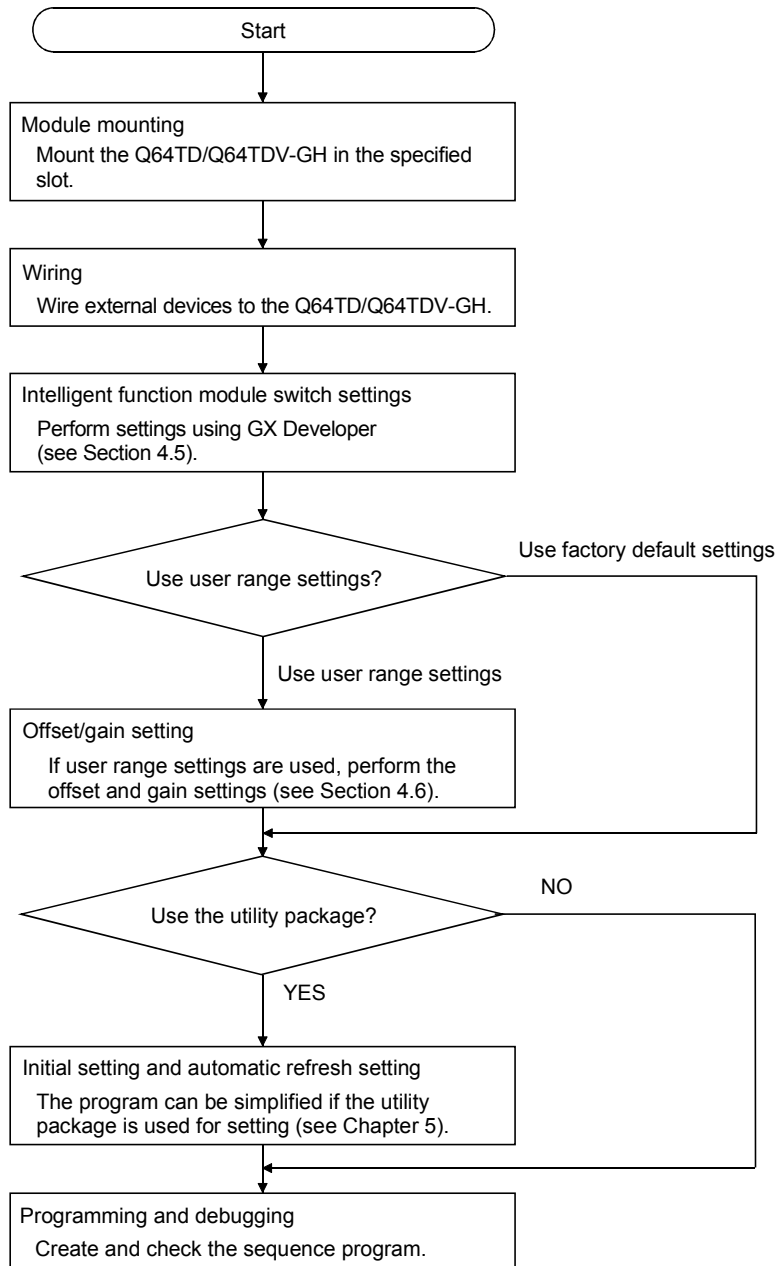

4.3 Part Names and Settings

The name of each part of the 64TD/Q64TDV-GH is listed below.

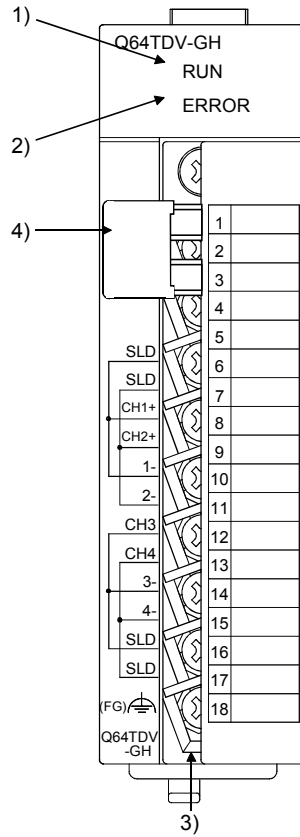
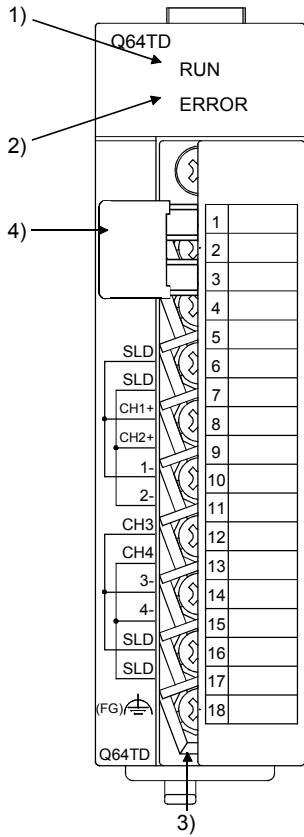

Terminal Block Layout	
Terminal number	Signal name
1	RTD +
2	Empty
3	RTD -
4	Empty
5	Empty
6	CH1 SLD
7	CH2 SLD
8	CH1 +
9	CH2 +
10	CH1 -
11	CH2 -
12	CH3 +
13	CH4 +
14	CH3 -
15	CH4 -
16	CH3 SLD
17	CH4 SLD
18	FG

Number	Name and Appearance	Description
1)	RUN LED	Indicates the operating status of the Q64TD. On : Operating normally. Flicker : Offset/gain setting mode Off : 5V power switched off, watchdog timer error occurred, or online module change enabled
2)	ERROR LED	Indicates the error status of the Q64TD. On : Error occurrence Flicker : Switch setting error Switch 5 was set to other than 0 in intelligent function module switch setting of GX Developer. Off : Operating normally.
3)	Terminal block	Used for wiring of the thermocouple, etc.
4)	Cold junction temperature compensation resistor	Used for cold junction temperature compensation using Pt100.

4.4 Wiring

The wiring precautions and examples of module connection are provided below.

4.4.1 Wiring instructions

In order to optimize the functions of the Q64TD/Q64TDV-GH and ensure system reliability, external wiring that is protected from noise is required.

Please observe the following precautions for external wiring:

- (1) Use separate cables for the AC control circuit and Q64TD/Q64TDV-GH's external input signals to avoid the influence of AC side surges and inductions.
- (2) Always place the thermocouple/micro voltage signal cable at least 100mm away from the main circuit cables and AC control lines.
Fully keep it away from high-voltage cables and circuits which include harmonics, such as an inverter's load circuit. Not doing so will make the module more susceptible to noises, surges and inductions.
- (3) Insulation-sleeved crimping terminals cannot be used with the terminal block. It is recommended to fit mark tubes or insulation tubes to the wire connection parts of the crimping terminals.

4.4.2 External wiring

(1) Thermocouple

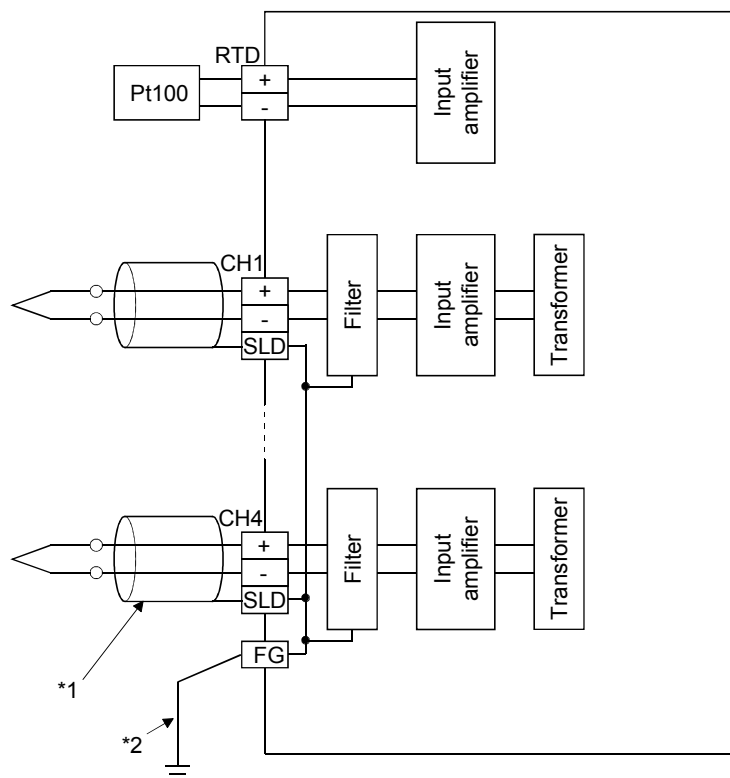

*1:As cables, always use shielded compensation conductors.

Also, wire the shielded cables as short as possible.

*2:Always connect to the earth terminal of the control box.

(2) Micro voltage signal

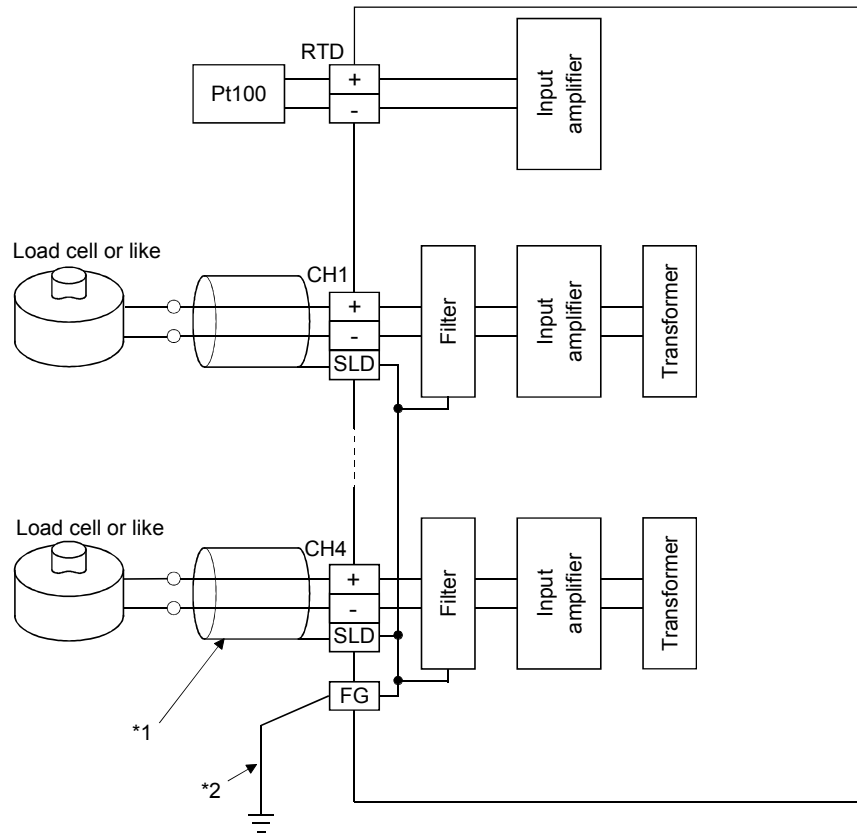

*1:As cables, always use shielded conductors.

Also, wire the shielded cables as short as possible.

*2:Always connect to the earth terminal of the control box.

4.5 Switch Setting for Intelligent Function Module

The settings for the intelligent function module are performed using the I/O assignment settings for GX Developer.

(1) Setting item

The intelligent function module switches consist of switches 1 to 5 and are set using 16 bit data. When the intelligent function module switches are not set, the default value for switches 1 to 5 is 0.

		Setting Item																				
Switch 1	<p>Input type setting</p> <p>CH4 CH3 CH2 CH1 H</p>	<table border="1"> <thead> <tr> <th>Input type</th> <th>Set value</th> </tr> </thead> <tbody> <tr> <td>Thermocouple K</td> <td>0</td> </tr> <tr> <td>Thermocouple E</td> <td>1</td> </tr> <tr> <td>Thermocouple J</td> <td>2</td> </tr> <tr> <td>Thermocouple T</td> <td>3</td> </tr> <tr> <td>Thermocouple B</td> <td>4</td> </tr> <tr> <td>Thermocouple R</td> <td>5</td> </tr> <tr> <td>Thermocouple S</td> <td>6</td> </tr> <tr> <td>Thermocouple N</td> <td>7</td> </tr> <tr> <td>Micro voltage input *1</td> <td>8</td> </tr> </tbody> </table>	Input type	Set value	Thermocouple K	0	Thermocouple E	1	Thermocouple J	2	Thermocouple T	3	Thermocouple B	4	Thermocouple R	5	Thermocouple S	6	Thermocouple N	7	Micro voltage input *1	8
Input type	Set value																					
Thermocouple K	0																					
Thermocouple E	1																					
Thermocouple J	2																					
Thermocouple T	3																					
Thermocouple B	4																					
Thermocouple R	5																					
Thermocouple S	6																					
Thermocouple N	7																					
Micro voltage input *1	8																					
Switch 2	<p>Offset/gain setting</p> <p>CH4 CH3 CH2 CH1 H</p>	<table border="1"> <thead> <tr> <th>Offset/gain setting</th> <th>Set value</th> </tr> </thead> <tbody> <tr> <td>Factory default</td> <td>0</td> </tr> <tr> <td>User range setting</td> <td>1</td> </tr> </tbody> </table>	Offset/gain setting	Set value	Factory default	0	User range setting	1														
Offset/gain setting	Set value																					
Factory default	0																					
User range setting	1																					
Switch 3	Empty																					
Switch 4	<p>0_H(numeric value other than 0_H) : With cold junction temperature compensation 1 to F_H *2 : Without cold junction temperature compensation Invalid when the setting of Switch 1 is 8 (micro voltage input)</p> <p>0_H(numeric value other than 0_H) : Normal mode 1 to F_H *2 : Offset/gain setting mode</p>																					
Switch 5	0 : Fixed																					

*1: Micro voltage input can be set on the Q64TDV-GH only.

*2: Setting any value within the setting range activates the same operation. In the setting range of 1 to FH, set 1 for example.

(2) Operating procedure

Start the settings with GX Developer assignment setting screen.

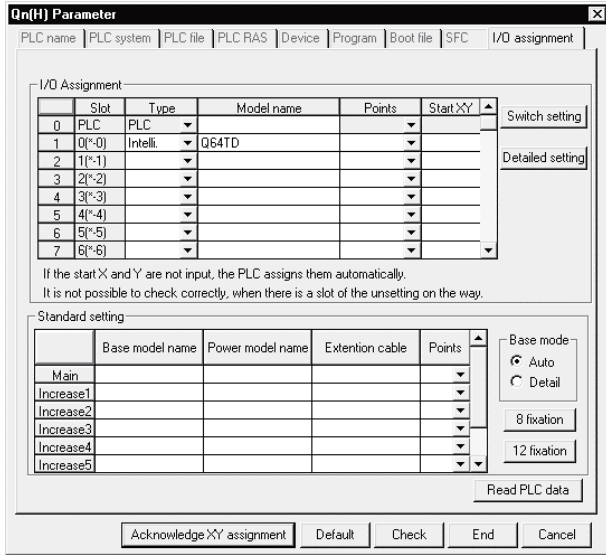

(a) I/O assignment setting screen

Set the following for the slot in which the Q64TD/Q64TDV-GH is mounted.

The type setting is required; set other items as needed.

- Type : Select "intelli."
- Model name : Enter the module model name.
- Points : Select 16 points.
- Start XY : Enter the start I/O number for the Q64TD/Q64TDV-GH.

Detailed setting : Specify the control PLC for the Q64TD/Q64TDV-GH. It is unnecessary to set the "Error time output mode" or "H/W error time PLC operation mode" since these settings are invalid for the Q64TD/Q64TDV-GH.

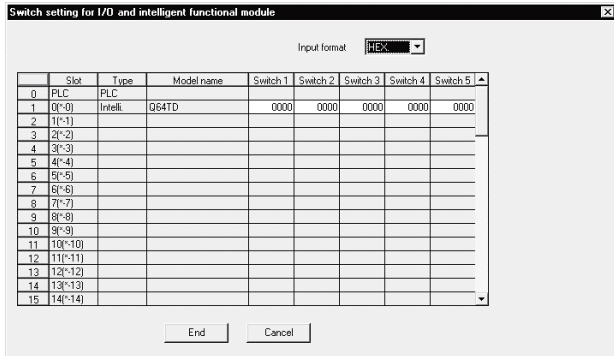

(b) Switch setting for intelligent function module screen

Click on [Switch setting] on the I/O assignment setting screen to display the screen shown at left, then set switches 1 to 5.

The switches can easily be set if values are entered in hexadecimal. Change the entry format to hexadecimal and then enter the values.

4.6 Offset/Gain Setting

Perform offset/gain settings in the procedure given in Section 4.6 (1) or Section 4.6 (2). When the industrial shipment setting is used, offset/gain setting is not necessary. If the utility package is installed, perform the offset/gain settings according to the procedure described in Section 5.6.2 or Section 5.6.3.

(1) Offset/gain setting for thermocouple input

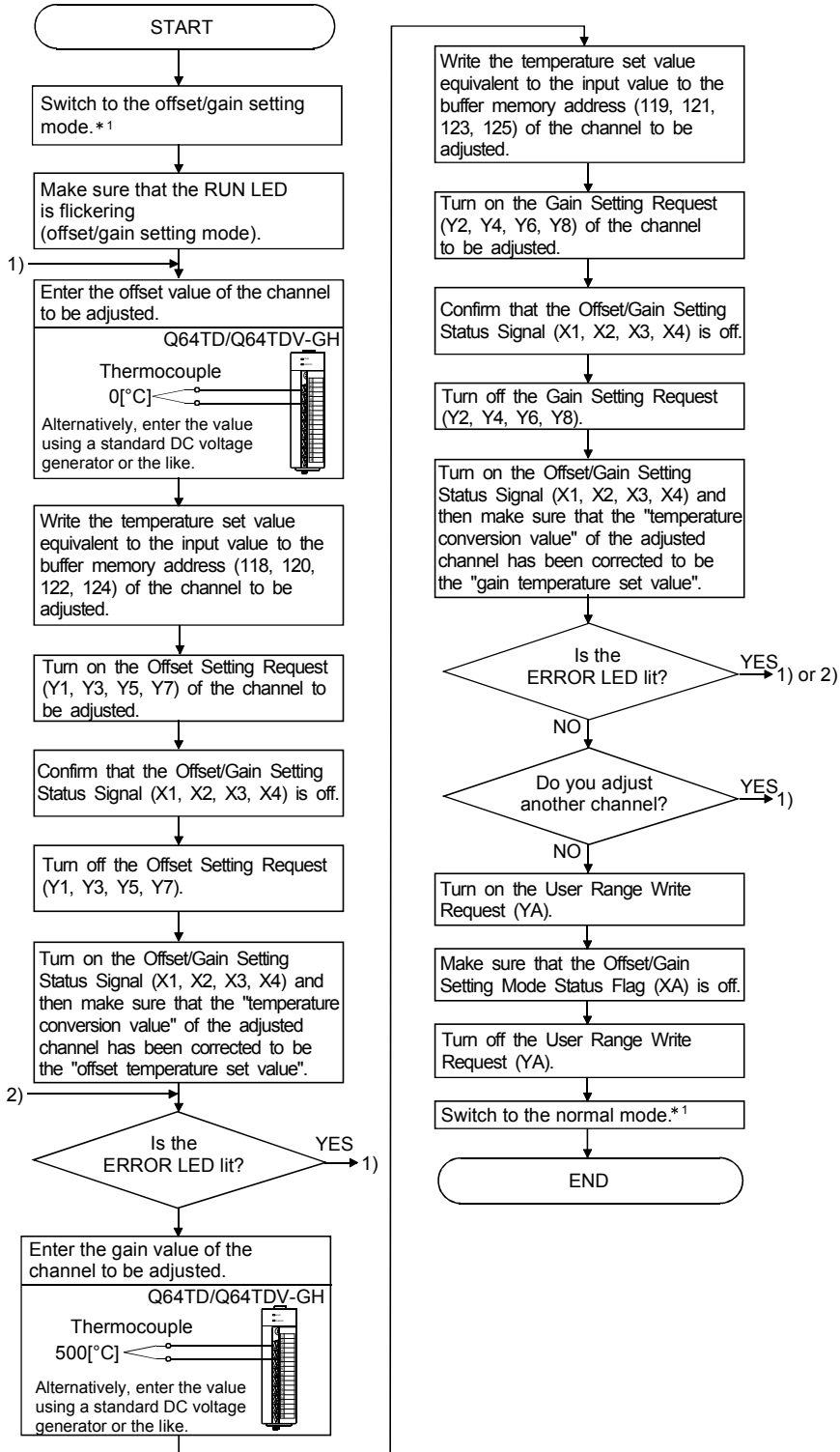

(2) Offset/gain setting for the micro voltage input

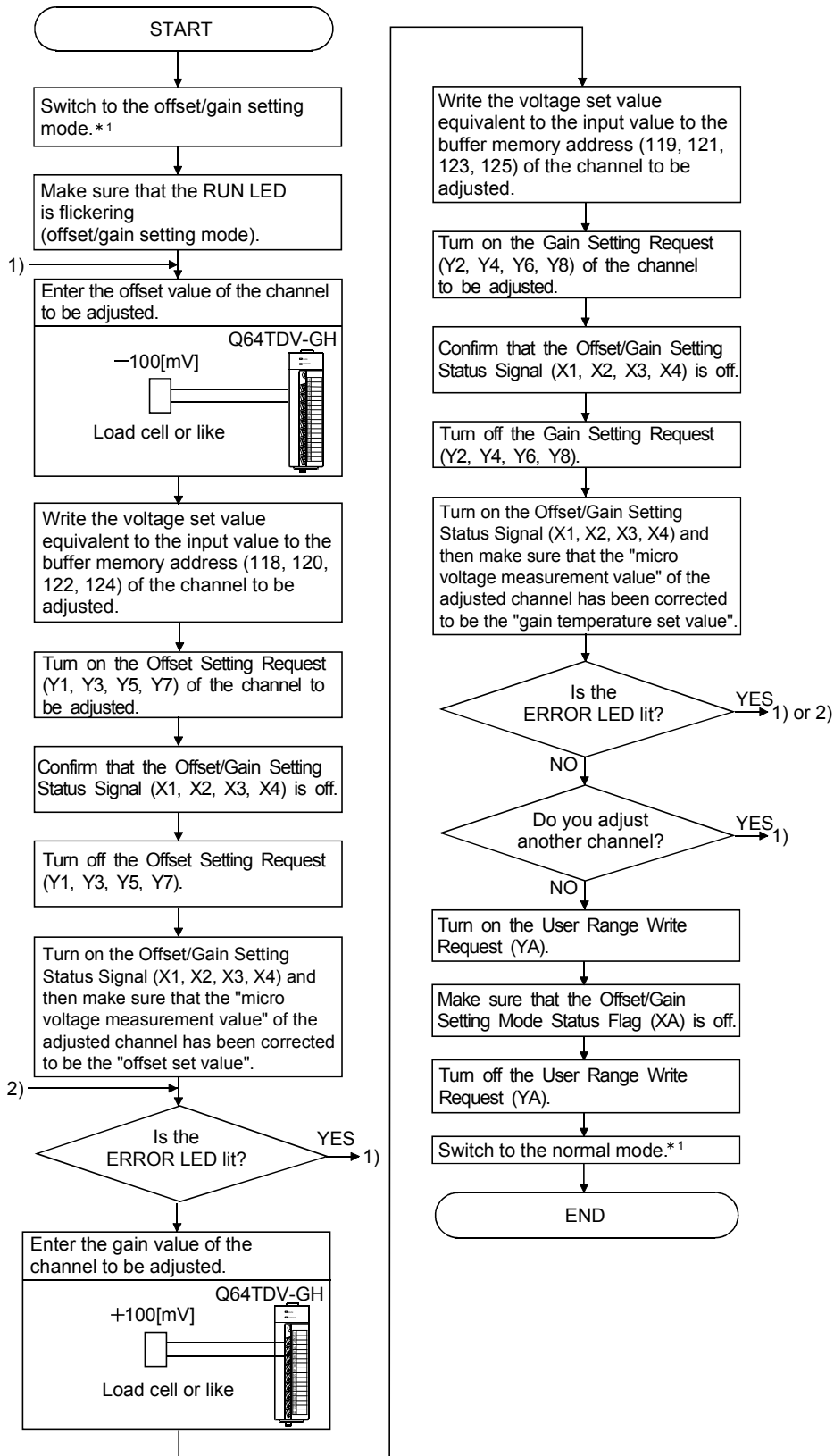

- *1 The mode switching (normal mode to offset/gain setting mode to normal mode) method is given below.
 - Dedicated instruction (G.OFFGAN) Refer to Section 4.6 (3), (a)
 - Setting made to mode switching setting (buffer memory addresses 158, 159: Un\G158, Un\G159) and turning the operation condition setting request (Y9) from OFF to ON Refer to Section 4.6 (3), (b)
 - Intelligent function module switch setting Refer to Section 4.5, Section 4.6 (3), (c) (After intelligent function module switch setting, reset the programmable controller CPU or switch power OFF, then ON.)

POINT
<ul style="list-style-type: none"> • Check the offset and gain values in the actual operating status. • By turning on the User Range Write Request (YA), the offset and gain values are stored into the E²PROM and will not be erased at power-off. • Make offset/gain setting within the measured temperature guarantee range (refer to Section 3.1.1 (2), Section 3.1.2 (2)) or within the measurable voltage range (refer to Section 3.1.2 (3)). If setting is made outside the measured temperature guarantee range or measurable voltage range, the resolution and accuracy may not fall within the ranges of the performance specifications. • Set the offset and gain values within the ranges where the following conditions are satisfied. (Gain value) - (offset value) > 0.1 [°C] (for temperature input) or (Gain value) - (offset value) > 4 [μV] (for micro voltage input) • Offset/gain setting may be made for two or more channels at the same time. • Do not set the offset and gain values concurrently. Doing so will cause an error, lighting up the ERROR LED. • If an error occurs during offset/gain setting, setting can be continued on another channel or the like. However, since the error remains occurring, turn on the Error Clear Request (YF) when you want to clear the error. • At the time of offset/gain setting, turn ON the user range write request (YA) to write the values to the E²PROM. Data can be written to the E²PROM up to 100 thousand times. To prevent accidental write to the E²PROM, an error will occur and the error code (buffer memory address 19: Un\G19) will be stored if write is performed 26. • If an error (error code: 40 □*¹) occurs during offset/gain setting, re-set the correct offset/gain value. The offset/gain value of the channel where the error has occurred is not written to the Q64TD/Q64TDV-GH. (*1: □ indicates the corresponding channel number.) • The module ready (X0) turns from OFF to ON when the offset/gain setting mode is switched to the normal mode by the setting of the dedicated instruction (G.OFFGAN) or mode switching setting (buffer memory addresses 158, 159: Un\G158, Un\G159). Note that initial setting processing will be executed if there is a sequence program that will perform initial setting when the module ready (X0) turns on. Also, for only the Q64TD, the error is cleared when the mode is switched. • The factory default offset/gain values, user range settings offset/gain values and user range settings thermal EMF offset/gain values (buffer memory addresses 160 to 255: Un\G160 to 255) are related with the user range save/restore function and allow users to re-set the offset/gain values easily in the case of online module change. These areas are not used for the offset/gain setting.

(2) Program examples

The program in the dotted area of (a) is common to (a), (b) and (c).

In this example, the I/O signals for Q64TD/Q64TDV-GH are X/Y0 to X/YF.

- Offset request M0
- Gain request M1
- Write request..... M2
- Mode switching M3
- Offset/gain temperature set value D0
- Dedicated instruction (G.OFFGAN) set value storage device D1

(a) When dedicated instruction (G.OFFGAN) is used to change mode

The following program example is designed to shift to the offset/gain setting mode using the dedicated instruction (G.OFFGAN) and write the offset and gain values of CH1 to the Q64TD/Q64TDV-GH.

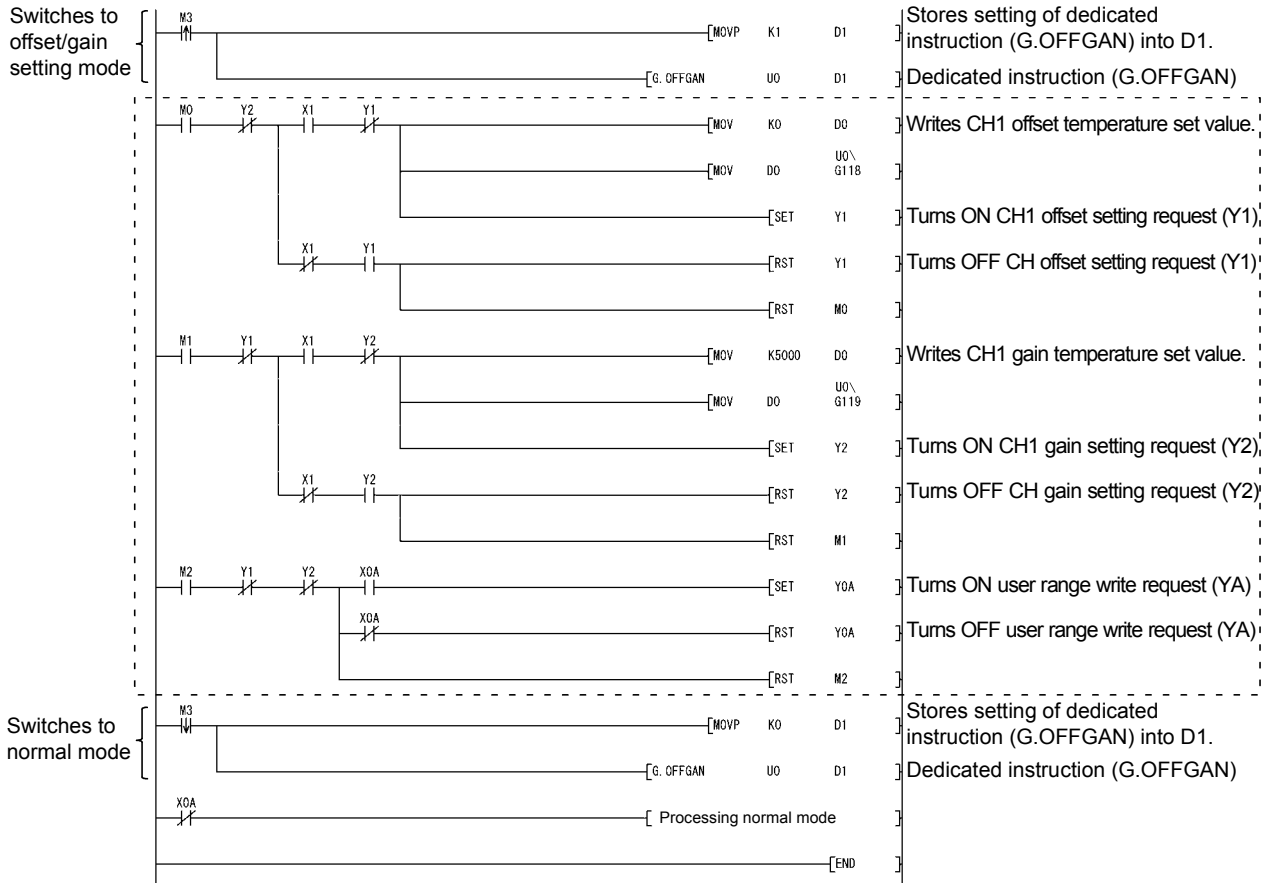

* The program in the dotted area is a common program.

(b) When switching the mode using the setting of the mode switching setting (buffer memory addresses 158, 159: Un\G158, Un\G159) and operating condition setting request (Y9)

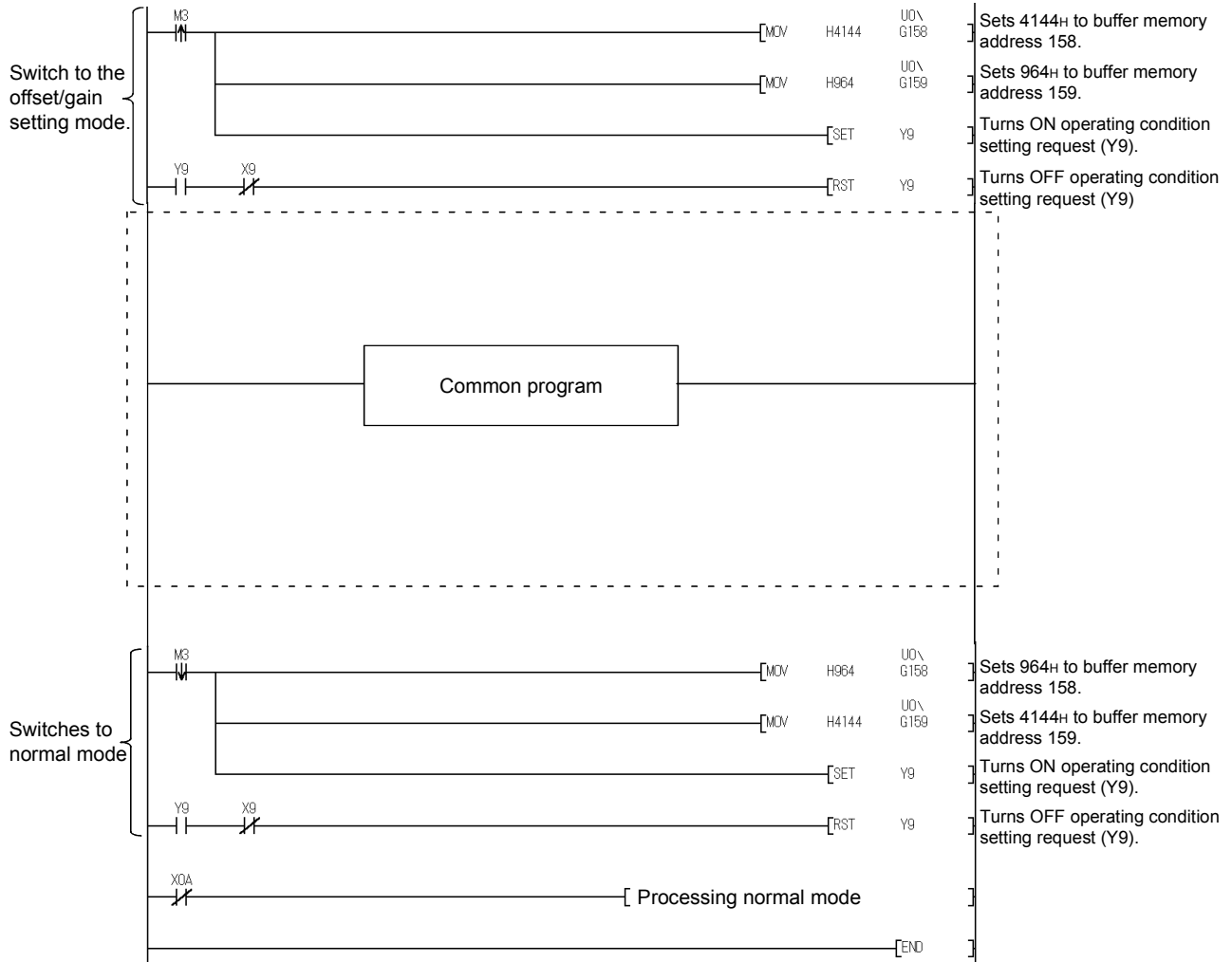

(c) When switching the mode by making intelligent function module switch setting
Only the common program is necessary.

4.7 Cold Junction Temperature Compensation Yes/No Setting

The Q64TD/Q64TDV-GH can perform the following two different cold junction temperature compensations by making intelligent function module switch setting (switch 4) to select whether a cold junction temperature compensation will be made or not using the Pt100 temperature-measuring resistor.

(1) Pt100 temperature-measuring resistor is used to perform cold junction temperature compensation (cold junction temperature compensation set for "Yes")

A cold junction temperature compensation using the Pt100 temperature-measuring resistor attached to the Q64TD/Q64TDV-GH is made automatically.

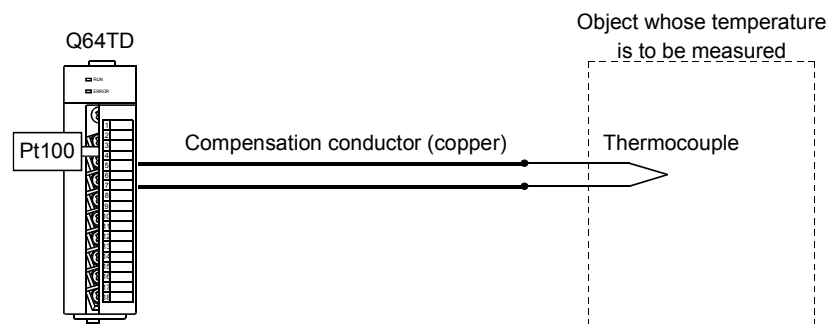

(2) Cold junction temperature compensation is performed externally (cold junction temperature compensation set for "No")

Use this compensation when you want to make temperature measurement at so high accuracy that the cold junction temperature compensation accuracy using the Pt100 temperature-measuring resistor attached to the Q64TD/Q64TDV-GH cannot be ignored as an error.

By providing a precision ice bath externally, the thermoelectromotive force generated at the tip of the thermocouple can be led to this module without any change, improving the cold junction temperature compensation accuracy.

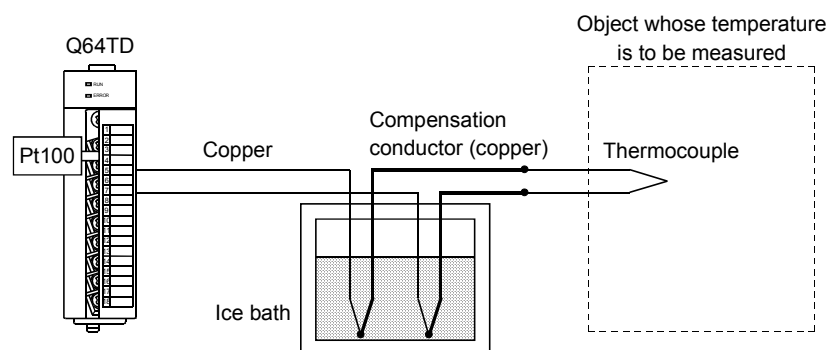

POINT

- The ice bath is designed to connect the thermocouple and conductor in the pot whose internal temperature is controlled to be 0°C. Hence, the thermoelectromotive force at the contact portion of the thermocouple and conductor will be 0mV, preventing the generation of extra thermoelectromotive force which can cause errors.
- Use the accessory Pt100 temperature-measuring resistor as it is connected.

5 UTILITY PACKAGE (GX Configurator-TI)

5.1 Utility Package Functions

Table 5.1 shows a list of the utility package functions.

Table 5.1 Utility Package (GX Configurator-TI) Function List

Function	Description	Reference section
Initial setting	<p>(1) Make initial setting for operating the Q64TD/Q64TDV-GH channel-by-channel. Set the values of the items which require initial setting.</p> <ul style="list-style-type: none"> • Conversion Enable/Disable Setting • Sampling Averaging Processing Selection • Time/Count Averaging Selection • Time/Count Averaging Setting • Warning Output Enable/Disable Setting • Thermocouple Type (Q64TD) • Setting Range (Q64TDV-GH) • Warning Output Lower Lower Limit Value • Warning Output Lower Upper Limit Value • Warning Output Upper Lower Limit Value • Warning Output Upper Upper Limit Value • Scaling Range Lower Limit Value • Scaling Range Upper Limit Value • Scaling Width Lower Limit Value • Scaling Width Upper Limit Value • Conversion setting for disconnection detection • Conversion setting value for disconnection detection <p>(2) The data for which initial setting has been completed is registered in the parameters for the programmable controller CPU, and automatically written to the Q64TD/Q64TDV-GH when the programmable controller CPU changes to the RUN status.</p>	Section 5.4
Automatic refresh	<p>(1) Set the automatically refreshed Q64TD/Q64TDV-GH buffer memory channel-by-channel.</p> <ul style="list-style-type: none"> • Conversion Completion Flag • CH <input type="checkbox"/> Measured Temperature Value (Q64TD) • CH <input type="checkbox"/> Measured Temperature Value/ Micro Voltage Conversion Value (Q64TDV-GH) • Error Code • Setting Range (Q64TD) • Signal Range 1 (Q64TDV-GH) • Warning Output Flag • Disconnection Detection Flag • CH <input type="checkbox"/> Scaling Value <p>(2) The values stored in the Q64TD/Q64TDV-GH buffer memory where automatic refresh setting was made are automatically read or written when the END instruction of the programmable controller CPU is executed.</p>	Section 5.5



Function	Description	Reference section
<p>Monitor/test</p>	<p>Monitors and tests the buffer memory and I/O signals for the Q64TD/Q64TDV-GH.</p> <ul style="list-style-type: none"> • Module Ready • Operating Condition Setting Completion Signal • Operating Condition Setting Request • Offset/gain Setting Mode Status Flag • User Range Write Request • Disconnection Detection Signal <p>(1) CH□ Monitor/Test</p> <ul style="list-style-type: none"> • Conversion Enable/Disable Setting • Sampling/Averaging Processing Selection • Time/Count Averaging Selection • Time/Count Averaging Setting • Conversion Completion Flag • Measured Temperature Value (Q64TD) • Measured Temperature Value/Micro Voltage Conversion Value (Q64TDV-GH) • Error Code • Thermocouple Type (Q64TD) • Setting Range 1 (Q64TDV-GH) • Warning Output Enable/Disable Setting • Warning Output Flag Lower Limit Value (Q64TD) • Warning Output Flag Upper Limit Value <p>(2) Offset/Gain Setting</p> <ul style="list-style-type: none"> • Mode Switching Setting • Mode Switching Setting Status • CH□ Thermocouple Type (Q64TD) • CH□ Setting Range 1 (Q64TDV-GH) • CH□ Offset Temperature Setting Value (Q64TD) • CH□ Offset Setting Value (Q64TDV-GH) • CH□ Offset Setting Request • CH□ Gain Temperature Setting Value (Q64TD) <p>(3) X/Y Monitor/Test</p> <ul style="list-style-type: none"> • Xn0: Module Ready • Xn1: CH1 Offset/Gain Setting Status Signal • Xn2: CH2 Offset/Gain Setting Status Signal • Xn3: CH3 Offset/Gain Setting Status Signal • Xn4: CH4 Offset/Gain Setting Status Signal • Xn9: Operating Condition Setting Completion Signal • XnA: Offset/Gain Setting Mode Status Flag • XnC: Disconnection Detection Flag • XnD: Warning Output Signal • XnE: Conversion Completion Flag <p>(4) OMC refresh</p> <ul style="list-style-type: none"> • CH□ Factory default offset/gain value • CH□ User range settings thermal EMF offset/gain value • OMC refresh data write request <ul style="list-style-type: none"> • Warning Output Signal • Conversion Completion Flag • Error Signal • Error Clear Request • Warning Output Lower Lower Limit Value • Warning Output Lower Upper Limit Value • Warning Output Upper Lower Limit Value • Warning Output Upper Upper Limit Value • Disconnection Detection Flag • Scaling Value • Scaling Range Lower Limit Value • Scaling Range Upper Limit Value • Scaling Width Lower Limit Value • Scaling Width Upper Limit Value • Conversion setting for disconnection detection *2 • Conversion setting value for disconnection detection *2 • CH□ Gain Setting Value (Q64TDV-GH) • CH□ Gain Setting Request • CH□ Measured Temperature Value (Q64TD) • CH□ Measured Temperature Value/Micro Voltage Conversion Value (Q64TDV-GH) • User Range Write Request • Offset/Gain Setting Mode Status Flag • XnF: Error Flag • Yn1: CH1 Offset Setting Request • Yn2: CH1 Gain Setting Request • Yn3: CH2 Offset Setting Request • Yn4: CH2 Gain Setting Request • Yn5: CH3 Offset Setting Request • Yn6: CH3 Gain Setting Request • Yn7: CH4 Offset Setting Request • Yn8: CH4 Gain Setting Request • Yn9: Operating Condition Setting Request • YnA: User Range Write Request • YnF: Error Clear Request • CH□ User range settings offset/gain value • OMC refresh data read request 	<p>Section 5.6</p>

POINT

- *1 To make initial and automatic refresh settings, a maximum of 76 bytes are required for the intelligent function module parameters per module.
- *2 Monitoring only is available. The tests are not executable.

5.2 Installing and Uninstalling the Utility Package

For how to install or uninstall the utility package, refer to "Method of installing the MELSOFT Series" included in the utility package.

5.2.1 Handling precautions

The following explains the precautions on using the GX Configurator-TI:

(1) For safety

Since GX Configurator-TI is add-in software for GX Developer, read "Safety Precautions" and the basic operating procedures in the GX Developer Operating Manual.

(2) About installation

The GX Configurator-TI is add-in software for GX Developer Version 4 or later. Therefore, GX Configurator-TI must be installed on the personal computer that has already GX Developer Version 4 or later installed.

(3) Screen error of Intelligent function module utility

Insufficient system resource may cause the screen to be displayed inappropriately while using the Intelligent function module utility. If this occurs, close the Intelligent function module utility, GX Developer (program, comments, etc.) and other applications, and then start GX Developer and Intelligent function module utility again.

(4) To start the Intelligent function module utility

(a) In GX Developer, select "QCPU (Q mode)" for PLC series and specify a project.

If any PLC series other than "QCPU (Q mode)" is selected, or if no project is specified, the Intelligent function module utility will not start.

(b) Multiple Intelligent function module utilities can be started.

However, [Open parameters] and [Save parameters] operations under [Intelligent function module parameter] are allowed for one Intelligent function module utility only. Only the [Monitor/test] operation is allowed for the other utilities

(5) Switching between two or more Intelligent function module utilities

When two or more Intelligent function module utility screens cannot be displayed side by side, select a screen to be displayed on the top of others using the task bar.



(6) Number of parameters that can be set in GX Configurator-TI

When multiple intelligent function modules are mounted, the number of parameter settings must not exceed the following limit.

When intelligent function modules are installed to:	Maximum number of parameter settings	
	Initial setting	Auto refresh setting
Q00J/Q00/Q01CPU	512	256
Q02/Q02H/Q06H/Q12H/Q25HCPU	512	256
Q02PH/Q06PH/Q12PH/Q25PHCPU	512	256
Q12PRH/Q25PRHCPU	512	256
Q02UCPU	2048	1024
Q03UD/Q04UDH/Q06UDH/ Q13UDH/Q26UDH/Q03UDE/ Q04UDEH/Q06UDEH/Q13UDEH/ Q26UDEHCPU	4096	2048
MELSECNET/H remote I/O station	512	256

For example, if multiple intelligent function modules are installed to the MELSECNET/H remote I/O station, configure the settings in GX Configurator so that the number of parameter settings for all the intelligent function modules does not exceed the limit of the MELSECNET/H remote I/O station.

Calculate the total number of parameter settings separately for the initial setting and for the auto refresh setting.

The number of parameters that can be set for one module in GX Configurator-TI is as shown below.

Target module	Initial setting	Auto refresh setting
Q64TD	6 (Fixed)	13 (Max.)
Q64TDV-GH	6 (Fixed)	13 (Max.)

Example) Counting the number of parameter settings in Auto refresh setting

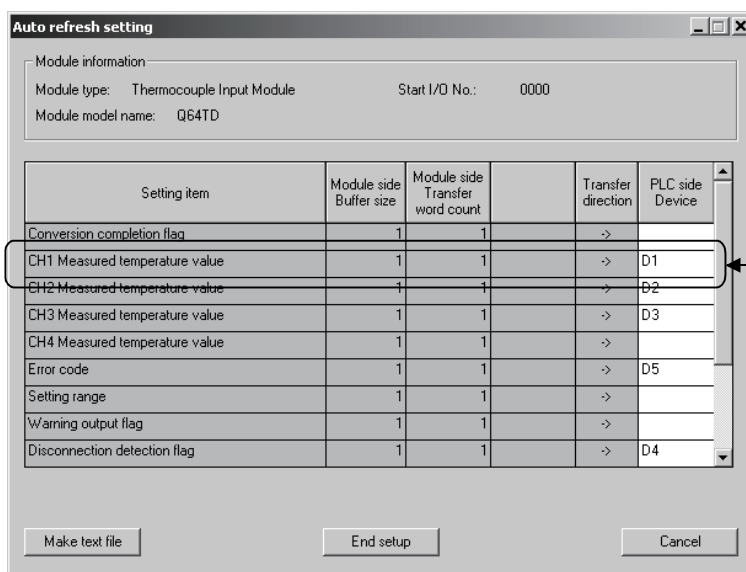

This one row is counted as one setting. Blank rows are not counted. Count up all the setting items on this screen, and add the total to the number of settings for other intelligent function modules to get a grand total.

5.2.2 Operating environment

This section explains the operating environment of the personal computer that runs GX Configurator-TI.

Item	Description
Installation (Add-in) target *1	Add-in to GX Developer Version 4 (English version) or later *2
Computer	Windows® based personal computer
CPU	Refer to the following table "Used operating system and performance required for personal computer".
Required memory	
Hard disk space *3	For installation
	For operation
Display	800 × 600 dots or more resolution *4
Operating system	Microsoft® Windows® 95 Operating System (English version) Microsoft® Windows® 98 Operating System (English version) Microsoft® Windows® Millennium Edition Operating System (English version) Microsoft® Windows NT® Workstation Operating System Version 4.0 (English version) Microsoft® Windows® 2000 Professional Operating System (English version) Microsoft® Windows® XP Professional Operating System (English version) Microsoft® Windows® XP Home Edition Operating System (English version) Microsoft® Windows Vista® Home Basic Operating System (English version) Microsoft® Windows Vista® Home Premium Operating System (English version) Microsoft® Windows Vista® Business Operating System (English version) Microsoft® Windows Vista® Ultimate Operating System (English version) Microsoft® Windows Vista® Enterprise Operating System (English version)

*1: Install GX Configurator-TI in GX Developer Version 4 or higher in the same language.

GX Developer (English version) and GX Configurator-TI (Japanese version) cannot be used in combination, and GX Developer (Japanese version) and GX Configurator-TI (English version) cannot be used in configuration. combination.

*2: GX Configurator-TI is not applicable to GX Developer Version 3 or earlier.

*3: At least 15GB is required for Windows Vista®.

*4: Resolution of 1024 X 768 dots or more is recommended for Windows Vista®.

Operating system and performance required for personal computer

Operating system	Performance required for personal computer	
	CPU	Memory
Windows® 95	Pentium® 133MHz or more	32MB or more
Windows® 98	Pentium® 133MHz or more	32MB or more
Windows® Me	Pentium® 150MHz or more	32MB or more
Windows NT® Workstation 4.0	Pentium® 133MHz or more	32MB or more
Windows® 2000 Professional	Pentium® 133MHz or more	64MB or more
Windows® XP Professional (Service Pack1 or more)	Pentium® 300MHz or more	128MB or more
Windows® XP Home Edition (Service Pack1 or more)	Pentium® 300MHz or more	128MB or more
Windows Vista® Home Basic	Pentium® 1GHz or more	1GB or more
Windows Vista® Home Premium	Pentium® 1GHz or more	1GB or more
Windows Vista® Business	Pentium® 1GHz or more	1GB or more
Windows Vista® Ultimate	Pentium® 1GHz or more	1GB or more
Windows Vista® Enterprise	Pentium® 1GHz or more	1GB or more

POINT
<ul style="list-style-type: none">•The functions shown below are not available for Windows® XP and Windows Vista®. <p>If any of the following functions is attempted, this product may not operate normally.</p> <ul style="list-style-type: none">Start of application in Windows® compatible modeFast user switchingRemote desktopLarge fonts (Details setting of Display Properties) <p>Also, 64-bit version Windows® XP and Windows Vista® are not supported.</p> <ul style="list-style-type: none">•Use a USER authorization or higher in Windows Vista®.

5.3 Utility Package Operation

5.3.1 Common utility package operations

(1) Control keys

Special keys that can be used for operation of the utility package and their applications are shown in the table below.

Key	Application
Esc	<p>Cancels the current entry in a cell.</p> <p>Closes the window.</p>
Tab	Moves between controls in the window.
Ctrl	Used in combination with the mouse operation to select multiple cells for test execution.
Delete	<p>Deletes the character where the cursor is positioned.</p> <p>When a cell is selected, clears all of the setting contents in the cell.</p>
Back Space	Deletes the character where the cursor is positioned.
↑ ↓ ← →	Moves the cursor.
Page Up	Moves the cursor one page up.
Page Down	Moves the cursor one page down.
Enter	Completes the entry in the cell.

(2) Data created with the utility package

The following data or files that are created with the utility package can be also handled in GX Developer. Figure 5.1 shows respective data or files are handled in which operation.

<Intelligent function module parameter>

- (a) This represents the data created in Auto refresh setting, and they are stored in an intelligent function module parameter file in a project created by GX Developer.

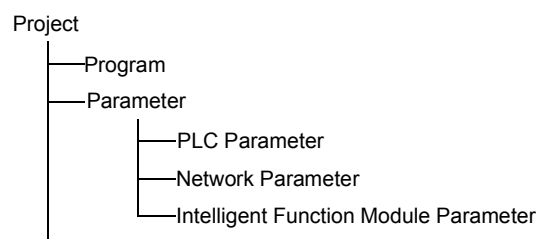

(b) Steps 1) to 3) shown in Figure 5.1 are performed as follows:

- 1) From GX Developer, select:
[Project] → [Open project] / [Save] / [Save as]
- 2) On the intelligent function module selection screen of the utility, select:
[Intelligent function module parameter] → [Open parameters] / [Save parameters]
- 3) From GX Developer, select:
[Online] → [Read from PLC] / [Write to PLC] "Intelligent function module parameters"
Alternatively, from the intelligent function module selection screen of the utility, select:
[Online] → [Read from PLC] / [Write to PLC]

<Text files>

(a) A text file can be created by clicking the **Make text file** button on the initial setting, Auto refresh setting, or Monitor/Test screen. The text files can be utilized to create user documents.

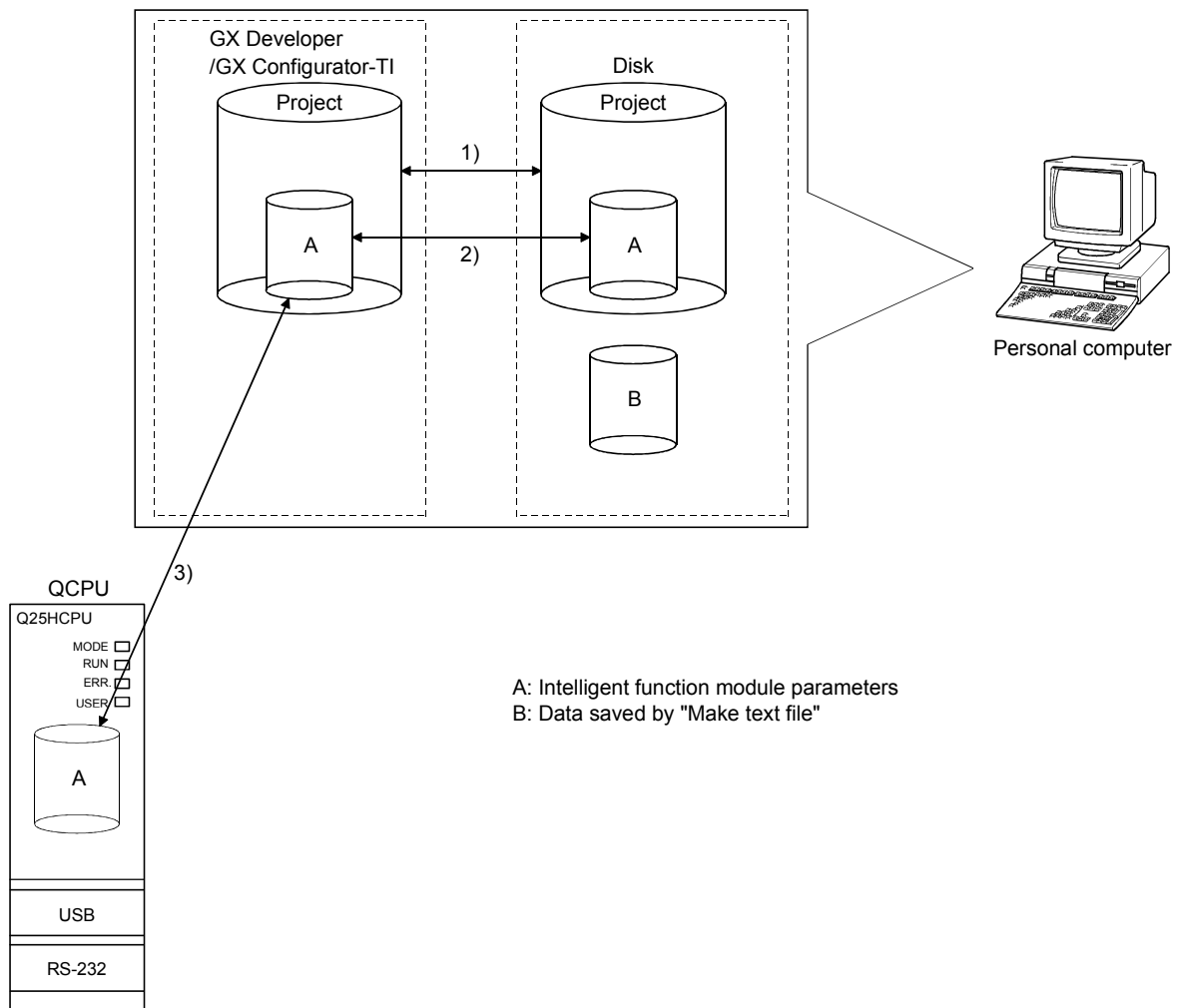
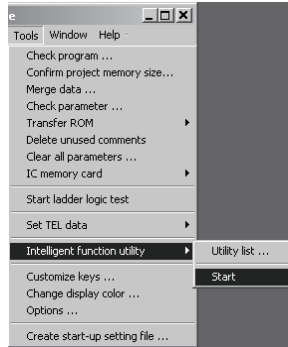

Figure 5.1 Correlation chart for data created with the utility package

5.3.2 Operation overview

GX Developer screen



[Tools] – [Intelligent function utility] – [Start]

Screen for selecting a target intelligent function module

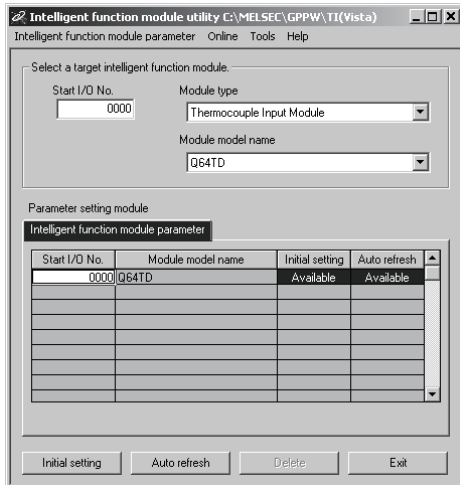

Refer to Section 5.3.3.

Enter "Start I/O No.", and select "Module type" and "Module model name".

Initial setting

Auto refresh

Initial setting screen

Automatic refresh setting screen

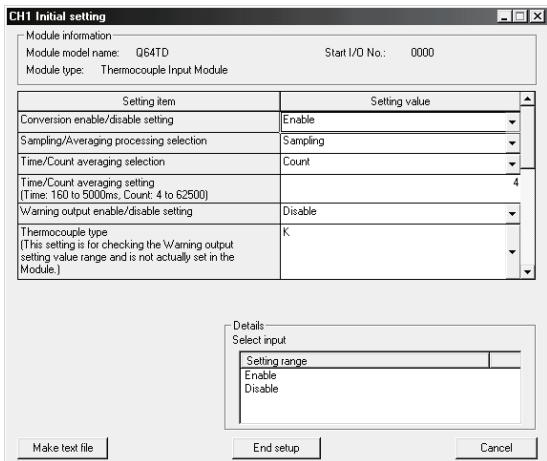

Refer to Section 5.4.

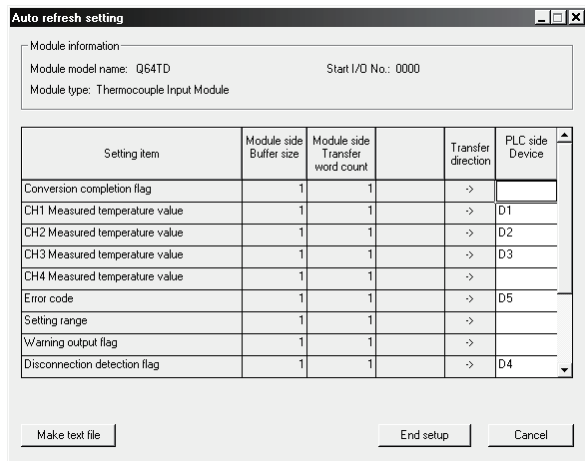

Refer to Section 5.5.

1) [Online] – [Monitor/Test]

Selecting monitor/test module screen

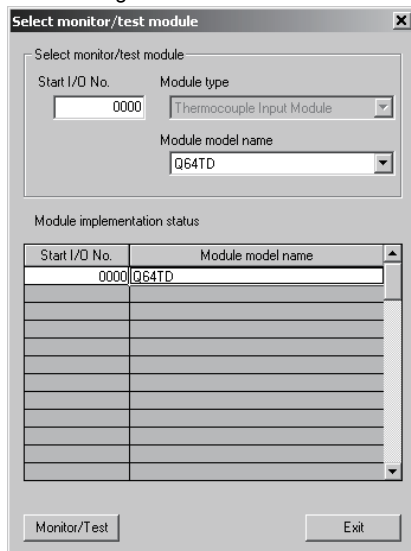

Select a module to be monitored/tested.

Monitor/Test screen

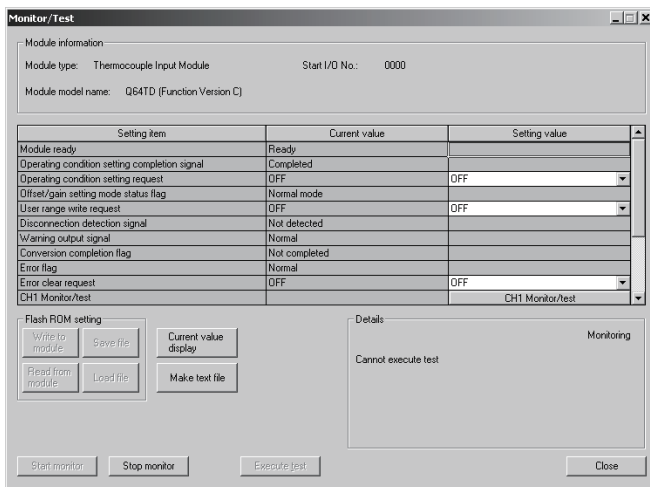

Refer to Section 5.6.

5.3.3 Starting the Intelligent function module utility

[Operating procedure]

Intelligent function module utility is started from GX Developer.

[Tools] → [Intelligent function utility] → [Start]

[Setting screen]

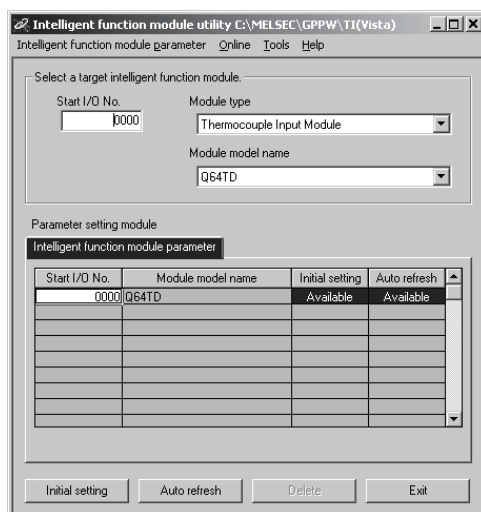

[Explanation of items]

(1) Activation of other screens

Following screens can be displayed from the intelligent function module utility screen.

(a) Initial setting screen

"Start I/O No. *1" → "Module type" → "Module model name" →

Initial setting

(b) Auto refresh setting screen

"Start I/O No. *1" → "Module type" → "Module model name" →

Auto refresh

(c) Select monitor/test module screen

[Online] → [Monitor/Test]

*1 Enter the start I/O No. in hexadecimal.

(2) Command buttons

Delete

Deletes the initial setting and auto refresh setting of the selected module.

Exit

Closes this screen.

(3) Menu bar

(a) File menu

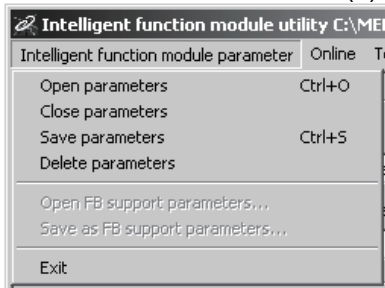

Intelligent function module parameters of the project opened by GX Developer are handled.

[Open parameters] : Reads a parameter file.

[Close parameters] : Closes the parameter file. If any data are modified, a dialog asking for file saving will appear.

[Save parameters] : Saves the parameter file.

[Delete parameters] : Deletes the parameter file.

[Exit] : Closes this screen.

(b) Online menu

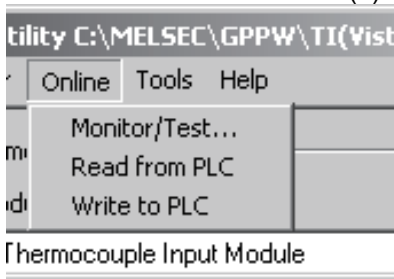

[Monitor/ Test] : Activates the Select monitor/test module screen.

[Read from PLC] : Reads the intelligent function module parameters from the CPU module.

[Write to PLC] : Writes the intelligent function module parameters to the CPU module.

POINT

(1) Saving intelligent function module parameters in a file

Since intelligent function module parameters cannot be saved in a file by the project saving operation of GX Developer, save them on the shown module selection screen for intelligent function module parameter setting.

(2) Reading/writing intelligent function module parameters from/to a programmable controller CPU using GX Developer

(a) Intelligent function module parameters can be read from and written into the programmable controller CPU after having been saved in a file.

(b) Set the target programmable controller CPU in GX Developer: [Online] → [Transfer setup].

(c) When the Q64TD/Q64TDV-GH is installed to the remote I/O station, use "Read from PLC" and "Write to PLC".

(3) Checking the required utility

While the start I/O is displayed on the Intelligent function module utility setting screen, "*" may be displayed for the model name.

This means that the required utility has not been installed or the utility cannot be started from GX Developer.

Check the required utility, selecting [Tools] - [Intelligent function utility] - [Utility list...] in GX Developer.

5.4 Initial Setting

[Purpose]

Make initial setting for operating the Q64TD/Q64TDV-GH on each channel.
Refer to Section 5.1 for the initial setting parameter types.
This initial setting makes sequence program setting unnecessary.

[Operating procedure]

"Start I/O No. *" → "Module type" → "Module model name" → Initial setting

* Enter the start I/O No. in hexadecimal.

[Setting screen]

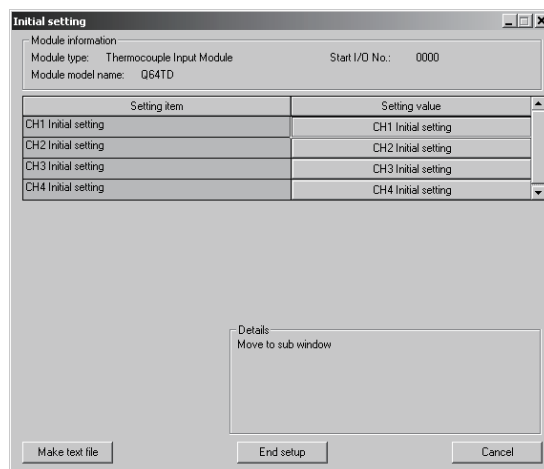

[Explanation of items]

(1) Setting contents

Set whether temperature conversion is enabled or disabled and the temperature conversion method for each channel.

(2) Command button

Make text file Creates a file containing the screen data in text file format.

End setup Saves the set data and ends the operation.

Cancel Cancels the setting and ends the operation.

POINT

Initial settings are stored in the intelligent function module parameters. After being written to the CPU module, the initial setting is made effective by either (1) or (2).

(1) Cycle the RUN/STOP switch of the CPU module: STOP → RUN → STOP → RUN.

(2) With the RUN/STOP switch set to RUN, turn off and then on the power or reset the CPU module.

When using a sequence program to write the initial settings, when the CPU is switched from STOP to RUN the initial settings will be written, So ensures that programming is carried out to re-execute the initial settings.

5.5 Auto Refresh Settings

[Purpose]

Configure the Q64TD/Q64TDV-GH's buffer memory for automatic refresh.

[Operating procedure]

"Start I/O No. *" → "Module type" → "Module model name" → Auto refresh

* Enter the start I/O No. in hexadecimal.

[Setting screen]

Setting item	Module side Buffer size	Module side Transfer word count	Transfer direction	PLC side Device
Conversion completion flag	1	1	->	
CH1 Measured temperature value	1	1	->	D1
CH2 Measured temperature value	1	1	->	D2
CH3 Measured temperature value	1	1	->	D3
CH4 Measured temperature value	1	1	->	
Error code	1	1	->	D5
Setting range	1	1	->	
Warning output flag	1	1	->	
Disconnection detection flag	1	1	->	D4

[Explanation of items]

(1) Items

- Model side Buffer size** : Displays the buffer memory size of the setting item that can be transferred (fixed at one word).
- Model side Transfer word count** : Displays the number of words to transfer the CPU device from the head device (fixed at one word).
- Transfer direction** : "←" indicates that data are written from the device to the buffer memory.
"→" indicates that data are loaded from the buffer memory to the device.
- PLC side Device** : Enter a CPU module side device that is to be automatically refreshed.
Applicable devices are X, Y, M, L, B, T, C, ST, D, W, R, and ZR.
When using bit devices X, Y, M, L or B, set a number that can be divided by 16 points (examples: X10, Y120, M16, etc.)
Also, buffer memory data are stored in a 16-point area, starting from the specified device number.
For example, if X10 is entered, data are stored in X10 to X1F.

(2) Command buttons

Creates a file containing the screen data in text file format.

Saves the set data and ends the operation.

Cancels the setting and ends the operation.

POINT

The auto refresh settings are stored in an intelligent function module parameter file. The auto refresh settings become effective by performing STOP → RUN → STOP → RUN operations for the CPU module, turning the power OFF and then ON or resetting the CPU module after writing the intelligent function module parameters to the CPU module.

However, processing equivalent to auto refresh can be added using the FROM/TO instruction in the sequence program.

5.6 Monitoring/Test

5.6.1 Monitor/test screen

[Purpose]

Start buffer memory monitoring/testing, I/O signal monitoring/testing, offset/gain settings (refer to Section 5.6.2, 5.6.3) and pass data (refer to Section 5.6.4) from this screen.

[Operating procedure]

"Select monitor/test module" screen → "Start I/O No.*" → "Module type" →

"Module model name" → **Monitor/test**

* Enter the start I/O No. in hexadecimal.

The screen can also be started from System monitor of GX Developer Version 6 or later.

Refer to the GX Developer Operating Manual for details.

[Setting screen]

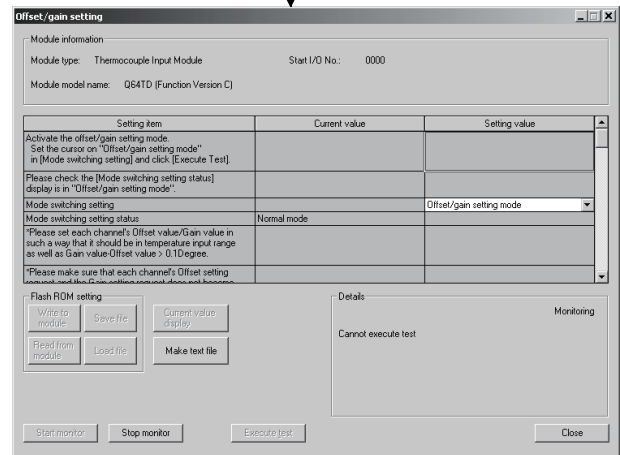
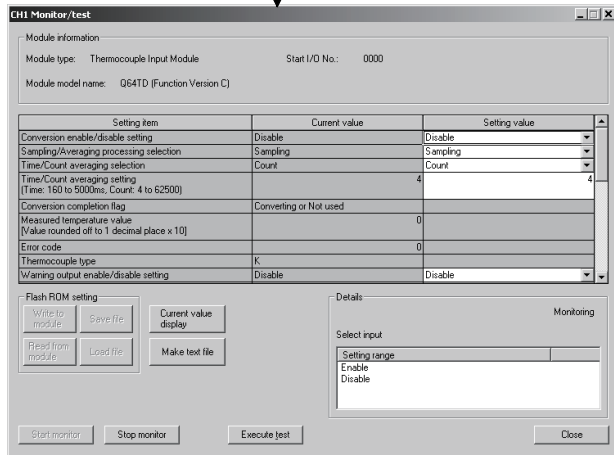
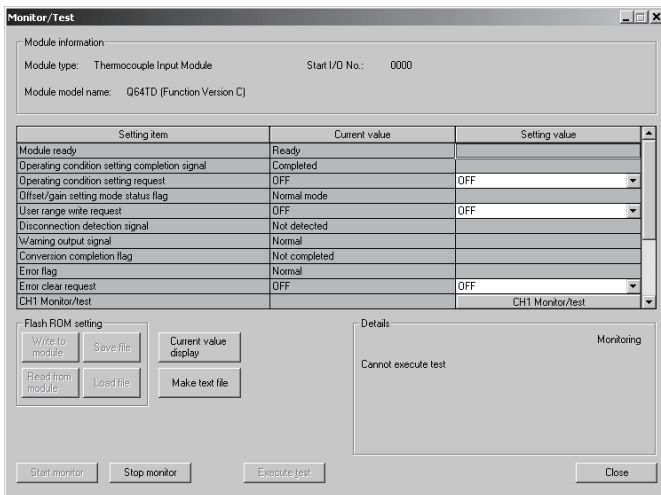

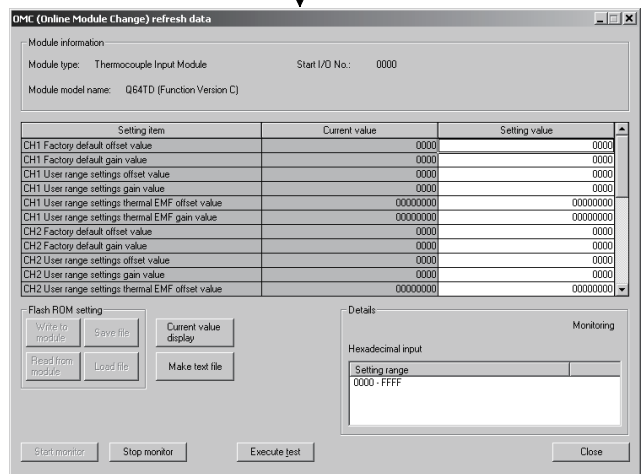
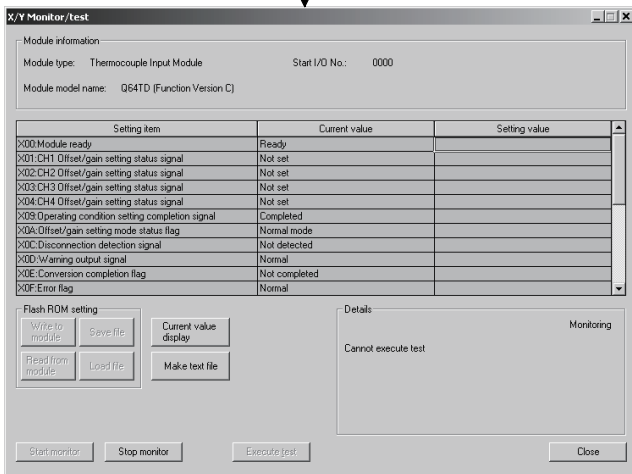

[Explanation of items]

(1) Items

- Setting item : Displays I/O signals and buffer memory names.
 Current value : Monitors the I/O signal states and present buffer memory values.
 Setting value : Enter or select the data to be written into the buffer memory for test operation.

(2) Command buttons

Current value display	Displays the current value of the item selected. (This is used to check the text that cannot be displayed in the current value field. However, in this utility package, all items can be displayed in the display fields).
Make text file	Creates a file containing the screen data in text file format.
Start monitor /	Selects whether or not to monitor current values.
Stop monitor	
Execute test	Performs a test on the selected items. To select more than one item, select them while holding down the Ctrl key.
Close	Closes the currently open screen and returns to the previous screen.

REMARK

The following describes an example where sampling processing for the selection test operation is changed to a 10-time averaging processing setting.

- (1) Set Averaging in the setting value field for CH□ Sampling/Averaging processing selection.
- (2) Set Count in the setting value field for CH□ Time/Count averaging selection.
- (3) Click the setting value field for CH□ Time Count averaging setting select.
- (4) After entering the number of times, press the Enter key.

At this point, nothing has been written to the Q64TD/Q64TDV-GH.

- (5) Select the setting value fields that were specified in steps 1 to 4 while holding down the Ctrl key.
- (6) Click Execute test to execute write operation.

Once writing has been completed, the value that was written will be displayed in the present value field.

5.6.2 Offset/gain setting operation (Function version C or later)

Perform the offset/gain setting operation in the following sequence.

(1) Switch to the offset/gain setting screen

Display the offset/gain setting screen using the operation described in Section 5.6.1.

(2) Switch to the offset/gain setting mode

Set "Offset/gain setting mode" in the Setting value field of Mode Switching Setting and click the button to perform write.

On completion of write, the indication in the Current value field of Mode Switching Setting Status changes to " Offset/gain setting mode ".

(3) Adjustment of the offset and gain values

(a) Set the offset value

Enter the desired value into the Setting value field for CH□ Offset Setting Value, and click the button.

(b) Determine the offset value

Select "Request" from the Setting value field for CH□ Offset Setting Request, and click the button. After making sure that the offset/gain setting status signal (X1, X2, X3, X4) has turned off, select "OFF" from the Setting value field for CH□ Offset Setting Request, and click the button.

(c) Set the gain value

Enter the desired value into the Setting value field for CH□ Gain Setting Value, and click the button.

(d) Determine the gain value

Select "Request" from the Setting value field for CH□ Gain Setting Request, and click the button. After making sure that the offset/gain setting status signal (X1, X2, X3, X4) has turned off, select "OFF" from the Setting value field for CH□ Gain Setting Request, and click the button.

(e) To set the offset/gain for more than one channel, repeat steps (a) to (d).

(4) Write the offset/gain setting values to the module

Write the offset/gain settings to the module after completing the settings for all channels using the user range setting. Note that if settings are written while offset/gain settings are incomplete, the status at that point will be written to the module.

(a) Write to the Q64TD/Q64TDV-GH

Select "Request" from the Setting value field for User Range Write Request, and click the button.

(b) Confirm execution of write and exit

After confirming that the indication of the Current value field for Offset/gain Setting Mode Status Flag changes from "Completed" to " Writing ", select "OFF" from the Setting value field for User Range Write Request, and click the button.

- (c) Error handling
Confirm that the ERR. LED for the Q64TD/Q64TDV-GH is off. If the ERR. LED is lit, click on , check the error code on the monitor screen, and then perform the offset/gain settings again.
- (5) Switch to the normal mode
Set "Normal mode" in the Setting value field of Mode Switching Setting and click the button to perform write.
On completion of write, the indication in the Current value field of Mode Switching Setting Status changes to "Normal mode".

5.6.3 Offset/gain setting operation (Function version B)

Perform the offset/gain setting operation in the following sequence.

(1) Switch to the offset/gain setting mode

Change switch 4 for intelligent function module switch setting to the offset/gain setting mode and switch 2 to the user range setting. (Refer to Section 4.5)

(2) Switch to the offset/gain setting screen

Display the offset/gain setting screen using the operation described in Section 5.6.1.

(3) Adjustment of the offset and gain values

(a) Set the offset value

Enter the desired value into the Setting value field for CH□ Offset Setting Value, and click the button.

(b) Determine the offset value

Select "Request" from the Setting value field for CH□ Offset Setting Request, and click the button. After making sure that the offset/gain setting status signal (X1, X2, X3, X4) has turned off, select "OFF" from the Setting value field for CH□ Offset Setting Request, and click the button.

(c) Set the gain value

Enter the desired value into the Setting value field for CH□ Gain Setting Value, and click the button.

(d) Determine the gain value

Select "Request" from the Setting value field for CH□ Gain Setting Request, and click the button. After making sure that the offset/gain setting status signal (X1, X2, X3, X4) has turned off, select "OFF" from the Setting value field for CH□ Gain Setting Request, and click the button.

(e) To set the offset/gain for more than one channel, repeat steps (a) to (d).

(4) Write the offset/gain setting values to the module

Write the offset/gain settings to the module after completing the settings for all channels using the user range setting. Note that if settings are written while offset/gain settings are incomplete, the status at that point will be written to the module.

(a) Write to the Q64TD

Select "Request" from the Setting value field for User Range Write Request, and click the button.

(b) Confirm execution of write and exit

After confirming that the indication of the Current value field for Offset/gain Setting Mode Status Flag changes from "Completed" to "Writing", select "OFF" from the Setting value field for User Range Write Request, and click the button.

(c) Error handling

Confirm that the ERR. LED for the Q64TD is off. If the ERR. LED is lit, click on , check the error code on the monitor screen, and then perform the offset/gain settings again.

5.6.4 OMC (Online Module Change) refresh data

Perform operation in the following sequence to save/restore the user range.

(1) Switch to the OMC refresh data screen

Perform the operation in Section 5.6.1 to display the OMC refresh data screen.

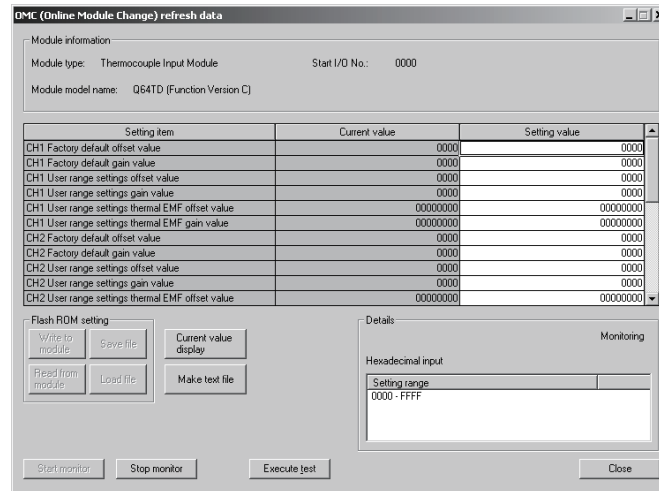

(2) User range saving

- (a) Change the Setting value field of Online Module Change read request to "Request", and click the **Execute test** button.

When read is completed, the values are displayed in the Current value fields of CH□ Factory default offset/gain value/User range settings offset/gain value/User range settings offset/gain thermal EMF value.

- (b) Compare the values with those in the range reference table, and take a note of the values if they are correct.
Refer to Section 7.4 for the range reference table.

(3) User range restoration

- (a) Set the noted values into the Setting value fields of CH□ Factory default offset/gain value/User range settings offset/gain value/User range settings thermal EMF offset/gain value.
- (b) Select all the Setting value fields of CH□ Factory default offset/gain input value/User range settings offset/gain value/User range settings thermal EMF offset/gain value, and click the **Execute test** button.

When write is completed, the set values are displayed in the Current value fields of them.

- (c) Change the Setting value field of online module change write request to "Request", and click the **Execute test** button.

Make sure that the indication in the Current value field of online module change write request changes from "Request" to "OFF" on completion of write.

6 PROGRAMMING

This chapter describes Q64TD/Q64TDV-GH programs.

When applying any of the program examples introduced in this chapter to the actual system, verify the applicability and confirm that no problems will occur in the system control.

6.1 Programs Used in Normal System Configuration

System configuration used to describe programs

(1) System configuration

Power supply module	QnCPU	Q64RD	QX41	QY41		
		X/Y0 to X/YF	X10 to X2F	Y30 to Y4F		

(2) Program conditions

This program reads the digital values of temperature conversions made on CH1 to CH3 of the Q64TD.

Sampling processing is to be set for CH1, and average processing of 500-count timing and 1000ms-interval is for CH2 and CH3 respectively.

If a write error occurs, the corresponding error code appears in BCD.

Disconnection detection is processed on CH1 only.

(a) Initial settings

- Temperature conversion enabled channelCH1 to CH3
- Sampling channelCH1
- Count-averaging channelCH2
- Time-averaging channelCH3

(b) Devices used by user

- Measured temperature value read command signal
(Turned on when user wants to read a measured temperature value) X10
- Disconnection detection reset signal X11
- Error reset signal
(Turned on when user wants to make error reset) X12
- Error code display (BCD 3digits) Y40 to Y4B
- Conversion completion flag M0 to M2
- Measured temperature value (16-bit) D1 to D3
(D11 to D13)
- Disconnection detection flag D4, M10
- Error code storage D5

POINT

Refer to Section 3.3 for the I/O signals (X0 to XF, Y0 to YF).

6.1.1 Program example when utility package is used

(1) Operation of utility package

(a) Initial setting (Refer to Section 5.4)

Set sampling processing for CH1, and averaging processing of 500-count timing and 1000ms-interval for CH2 and CH3 respectively.

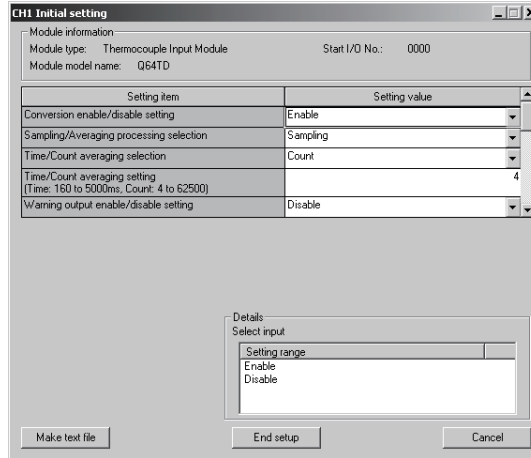

(b) Automatic refresh settings (Refer to Section 5.5)

Set the CH1 to CH3 measured temperature values and error code.

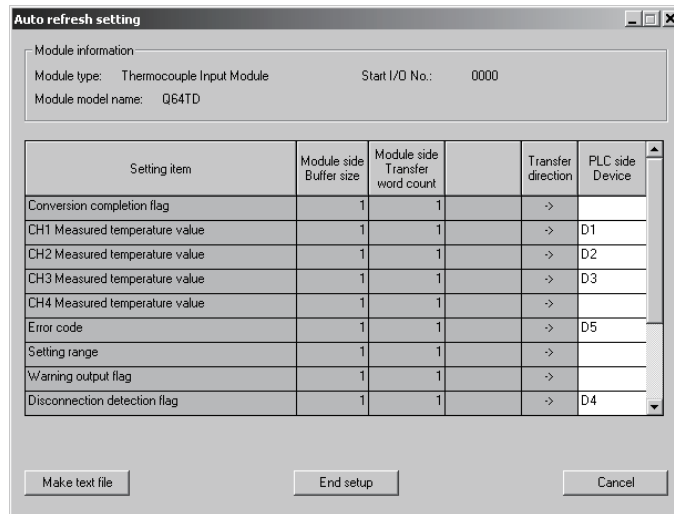

(c) Write of intelligent function module parameters (Refer to Section 5.3.3)

Write the intelligent function module parameters to the CPU module. Perform this operation on the parameter setting unit selection screen.

(2) Program example

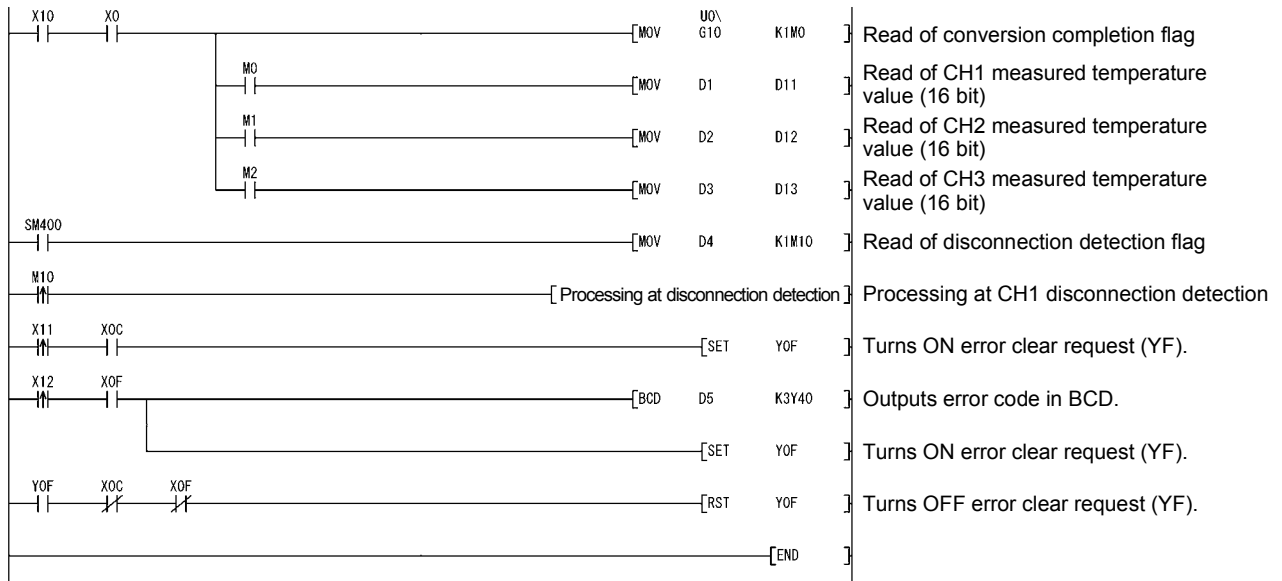

6.1.2 Program example when utility package is not used

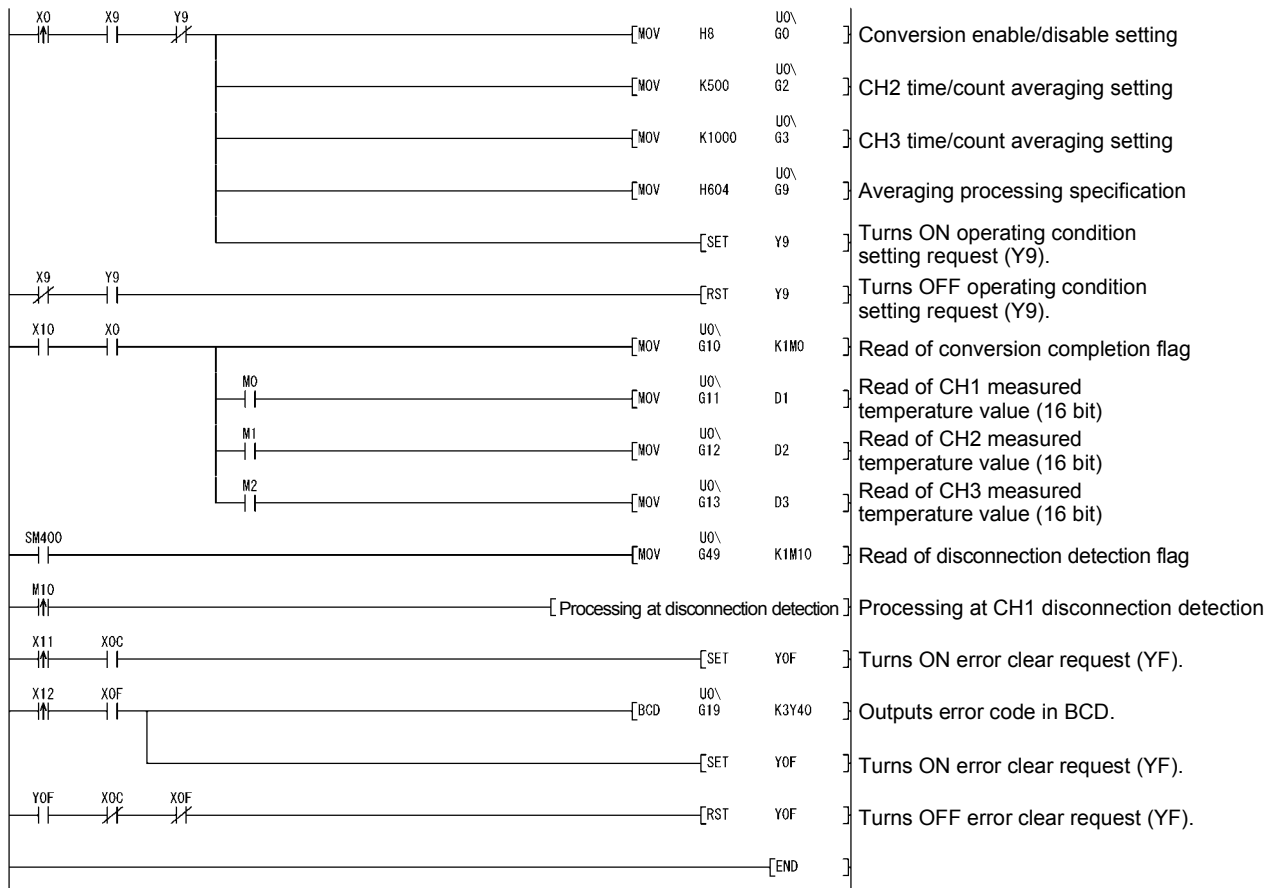

6.2 Programs Used on Remote I/O Network

System configuration used to describe programs

(1) System configuration

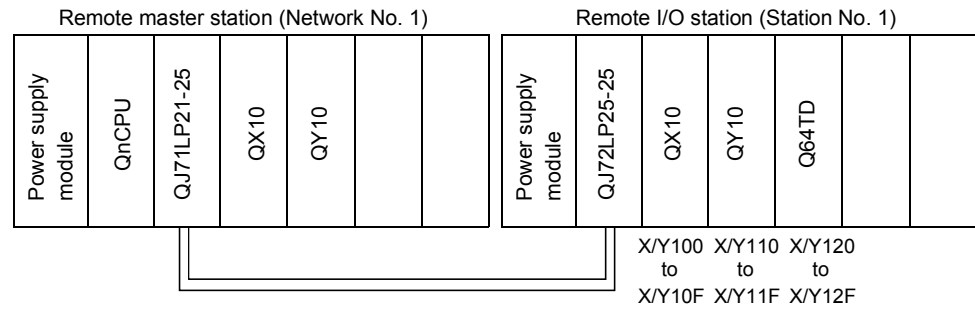

(2) Program conditions

This program was written for the CPU on the remote master station to read the digital values of temperature conversions made on CH1 to CH3 of the Q64TD. Sampling processing is to be set for CH1, and average processing of 500-count timing and 1000ms-interval is for CH2 and CH3 respectively. If a write error occurs, the corresponding error code appears in BCD. Disconnection detection is processed on CH1 only.

(3) Initial settings

- Temperature conversion enabled channelCH1 to CH3
- Sampling channelCH1
- Count averaging channelCH2
- Time averaging channelCH3
- CH2 averaging count500 times
- CH3 averaging time1000ms (1s)

(4) Devices used by user

- Initial setting request signalX20
- Measured temperature value read command signal
(Turned on when user wants to read a measured temperature value)X21
- Disconnection detection reset signalX22
- Error reset signal
(Turned on when user wants to make error reset)X23
- Error code display (BCD 3digits)Y30 to Y3B
- Conversion completion flagD10
- CH1 to 3 measured temperature value (16-bit)D1 to D3
(W1 to W3)
- Disconnection detection flagW4, M20
- Error code storageW15

POINT

- (1) Refer to Section 3.3 for the I/O signals (X120 to X12F, Y120 to Y12F).
- (2) For details on the MELSENET/H remote I/O network, refer to the Q Corresponding MELSENET/H Network System Reference Manual (Remote I/O Network).

6.2.1 Program example when utility package is used

(1) Operation of GX Developer

(a) Setting of CPU parameters

- Network type :MNET/H (remote master)
- First I/O No. :0000H
- Network No. :1
- Total number of (slave) stations :1
- Mode :Online
- Network range assignment :

StationNo.	M station -> R station						M station <- R station					
	Y			Y			X			X		
	Points	Start	End	Points	Start	End	Points	Start	End	Points	Start	End
1	256	0100	01FF	256	0000	00FF	256	0100	01FF	256	0000	00FF

StationNo.	M station -> R station			M station <- R station			M station -> R station			M station <- R station		
	B			B			W			W		
	Points	Start	End	Points	Start	End	Points	Start	End	Points	Start	End
1							160	0100	019F	160	0000	009F

• Refresh parameters:

Assignment method

Points/Start
 Start/End

Transient transmission error history status

Overwrite
 Hold

	Link side					PLC side			
	Dev. name	Points	Start	End		Dev. name	Points	Start	End
Transfer SB	SB	512	0000	01FF	↔	SB	512	0000	01FF
Transfer SW	SW	512	0000	01FF	↔	SW	512	0000	01FF
Random cyclic	LB				↔				
Random cyclic	LW				↔				
Transfer1	LB	8192	0000	1FFF	↔	B	8192	0000	1FFF
Transfer2	Lw	8192	0000	1FFF	↔	w	8192	0000	1FFF
Transfer3	LX	512	0000	01FF	↔	X	512	0000	01FF
Transfer4	LY	512	0000	01FF	↔	Y	512	0000	01FF
Transfer5					↔				
Transfer6					↔				

(2) Operation of utility package

Perform operation on the remote I/O station side.

Operate the utility package on the remote I/O station side.

Set the following in the Intelligent function module parameter setting module select area.

- Start I/O No. : 20
- Module type : Thermocouple Input Module
- Module model name: Q64TD / Q64TDV-GH

(a) Initial setting (Refer to Section 5.4)

Set sampling processing for CH1, and averaging processing of 500-count timing and 1000ms-interval for CH2 and CH3 respectively.

CH1 Initial setting

Module information

Module type: Thermocouple Input Module Start I/O No.: 0020

Module model name: Q64TD

Setting item	Setting value
Conversion enable/disable setting	Enable
Sampling/Averaging processing selection	Sampling
Time/Count averaging selection	Count
Time/Count averaging setting (Time: 160 to 5000ms; Count: 4 to 62500)	4
Warning output enable/disable setting	Disable

Details

Select input

Setting range

Enable

Disable

Make text file End setup Cancel

- (b) Automatic refresh settings (Refer to Section 5.5)
Set the CH1 to CH3 temperature measurement values and error code.

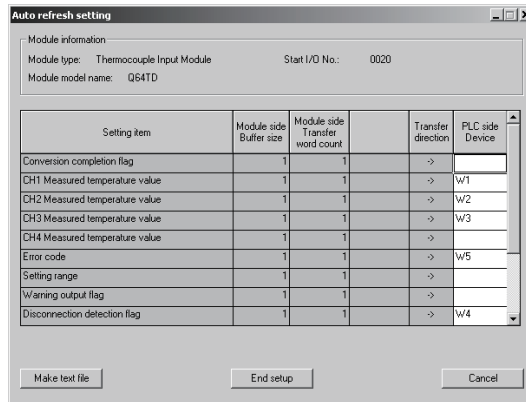

- (c) Write of intelligent function module parameters (refer to Section 5.3.3)
The intelligent function module parameters are written to the remote I/O station.
Perform this operation on the parameter setting unit selection screen.

(3) Program example

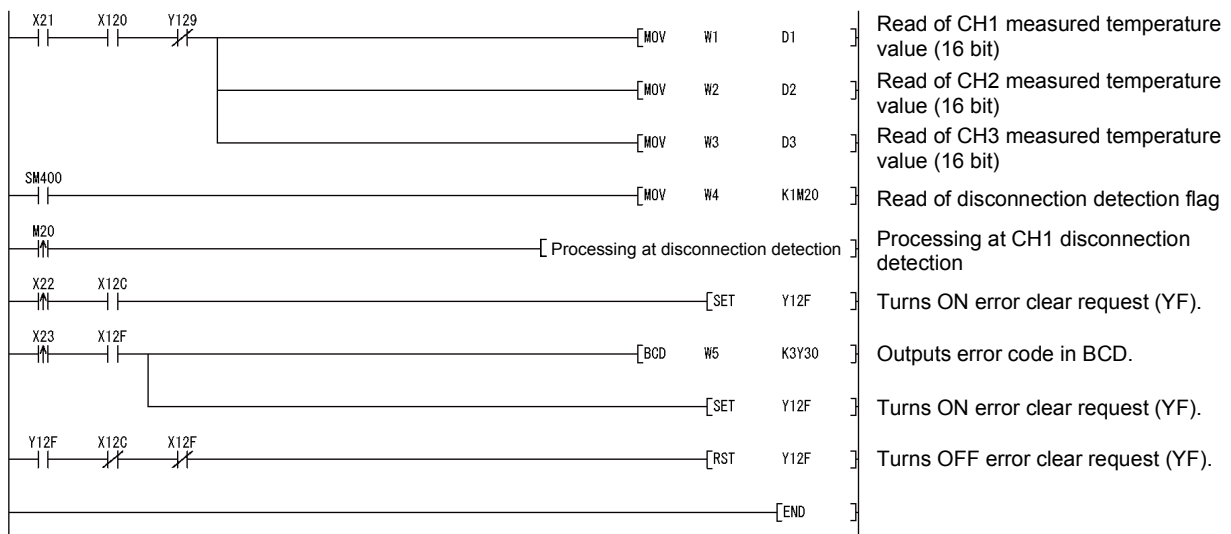

POINT

To write the intelligent function module parameters, set the target remote I/O station from [Online] - [Transfer setup] on GX Developer.
They can be written by:

- Directly connecting GX Developer to the remote I/O station.
- Connecting GX Developer to another device such as a CPU module and passing through the network.

6.2.2 Program example when utility package is not used

POINT
<p>The dedicated instructions used for reading/writing the buffer memory of the intelligent function module on a remote I/O station (REMTO and REMFR) are the execution type for which several scans are needed. Therefore, transmissions of the execution results are not synchronized with the I/O signal operations. When reading a measured temperature value on an Q64TD after changing the operating condition during operation, be sure to read the Conversion completed flag (buffer memory address 10) at the same time.</p> <p>Also, for the case of changing the operating condition, insert an interlock to prevent the execution of the REMFR instruction.</p>

(1) Operation of GX Developer (Setting of CPU parameters)

- Network type : MNET/H (remote master)
- First I/O No : 0000H
- Network No : 1
- Total number of (slave) stations : 1
- Mode : Online
- Network range assignment :

StationNo.	M station -> R station						M station <- R station					
	Y			Y			X			X		
	Points	Start	End	Points	Start	End	Points	Start	End	Points	Start	End
1	256	0100	01FF	256	0000	00FF	256	0100	01FF	256	0000	00FF

- Refresh parameters:

Assignment method

Points/Start

Start/End

Transient transmission error history status

Overwrite Hold

	Link side					PLC side			
	Dev. name	Points	Start	End		Dev. name	Points	Start	End
Transfer SB	SB	512	0000	01FF	↔	SB	512	0000	01FF
Transfer SW	SW	512	0000	01FF	↔	SW	512	0000	01FF
Random cyclic	LB				↔				
Random cyclic	LW				↔				
Transfer1	LB	8192	0000	1FFF	↔	B	8192	0000	1FFF
Transfer2	LW	8192	0000	1FFF	↔	W	8192	0000	1FFF
Transfer3	LX	512	0000	01FF	↔	X	512	0000	01FF
Transfer4	LY	512	0000	01FF	↔	Y	512	0000	01FF
Transfer5					↔				
Transfer6					↔				

(2) Program example

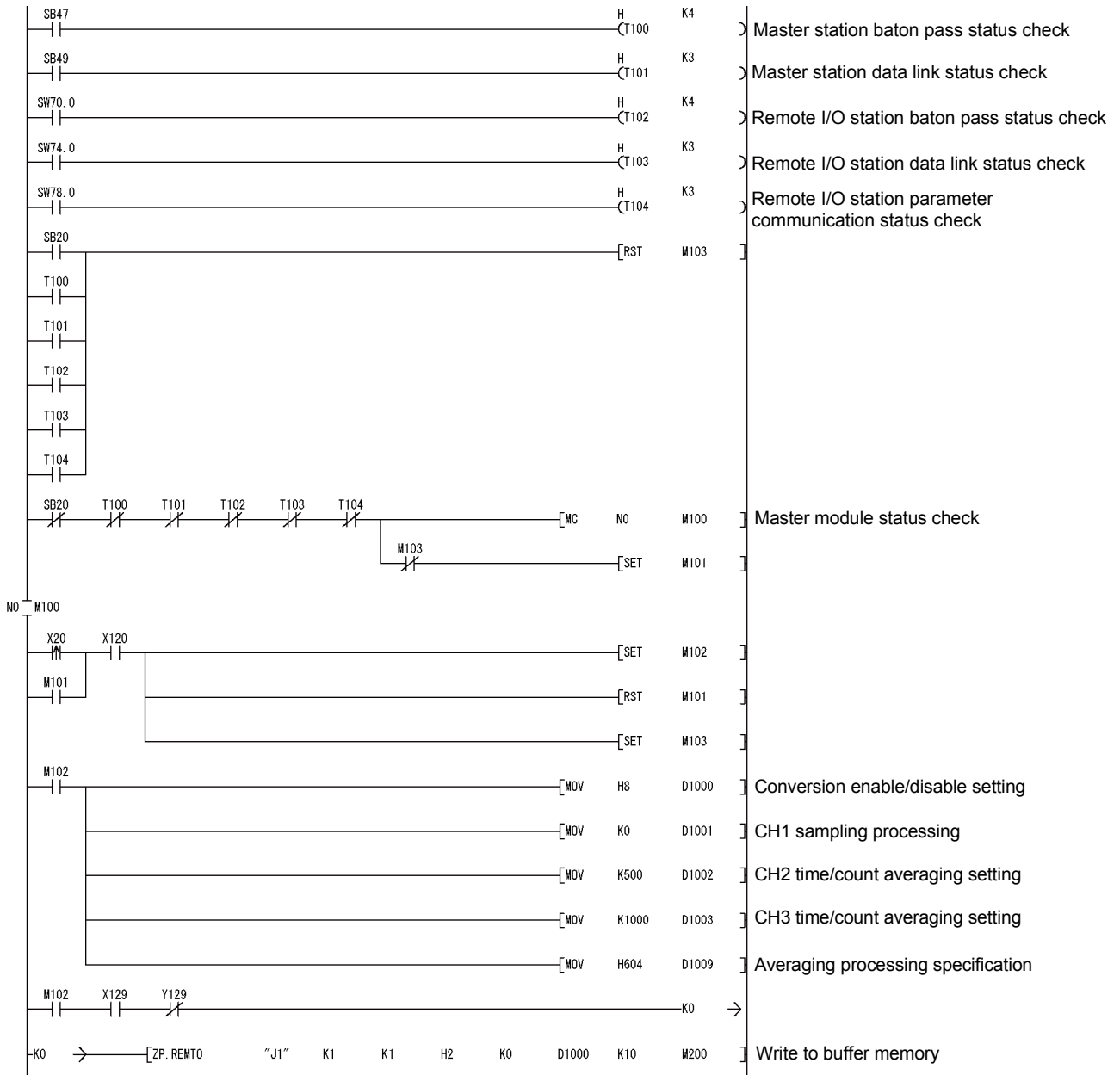

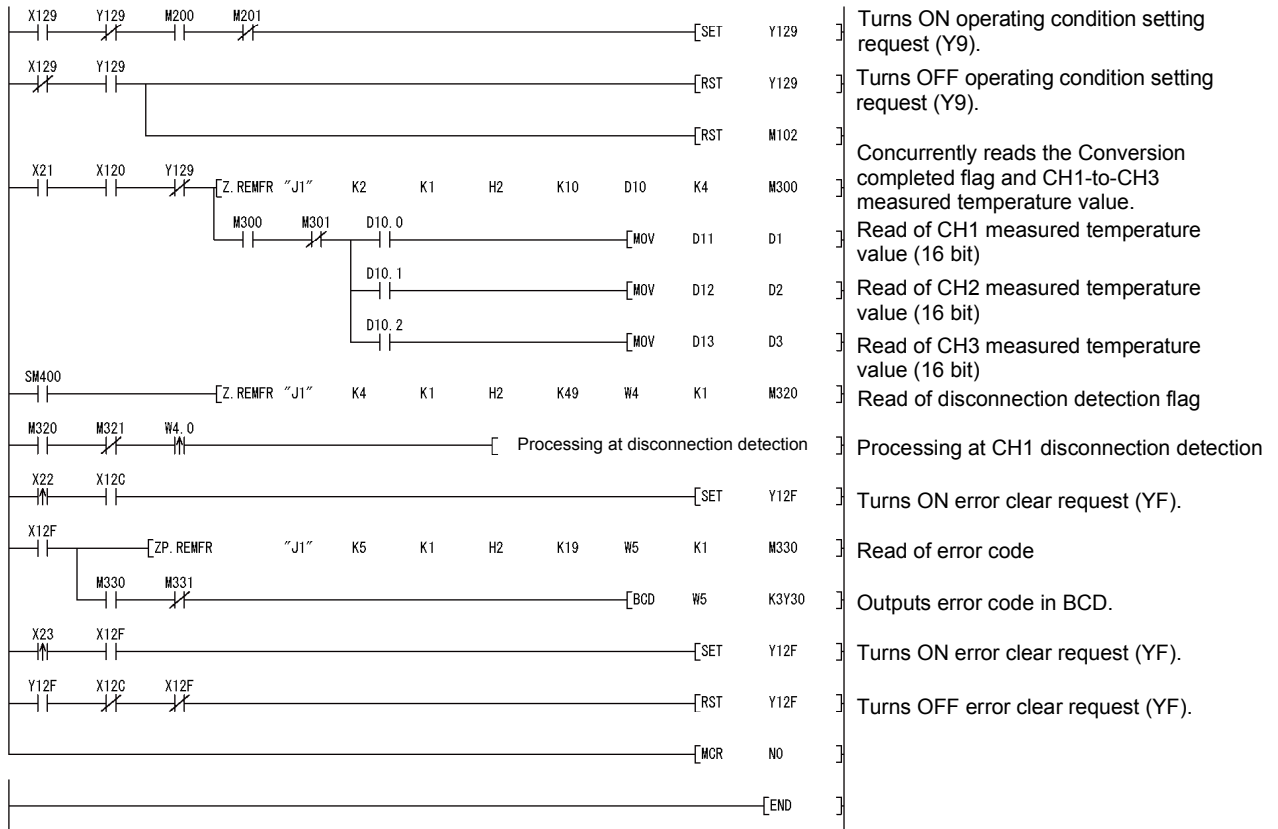

MEMO

7 ONLINE MODULE CHANGE

When changing a module online, carefully read the QCPU User's Manual (Hardware Design, Maintenance and Inspection), section 12.4.1 "Online module change".

This chapter describes the specifications of an online module change.

- (1) Perform an online module change by operating GX Developer.
- (2) To ensure ease of offset/gain re-setting, there is a user range save/restoration function that is performed by executing the dedicated instruction or read/write from/to buffer memory.

POINT
<p>(1) Perform an online module change after making sure that the system outside the programmable controller will not malfunction.</p> <p>(2) To prevent an electric shock and malfunction of operating modules, provide means such as switches for powering off each of the external power supply and external devices connected to the module to be replaced online.</p> <p>(3) After the module has failed, data may not be saved properly. Referring to Section 3.4.23, therefore, prerecord the data to be saved (Factory default offset/gain value/User range settings offset/gain value/User range settings thermal EMF offset/gain value in the buffer memory).</p> <p>(4) It is recommended to perform an online module change in the actual system in advance to ensure that it would not affect the other modules by checking the following:</p> <ul style="list-style-type: none"> • Means of cutting off the connection to external devices and its configuration are correct. • Switching ON/OFF does not bring any undesirable effect. <p>(5) Do not install/remove the module to/from the base unit, or the terminal block to/from the module more than 50 times after the first use of the product. (IEC 61131-2 compliant) Failure to do so may cause malfunction.</p>

(Note)

The dedicated instruction cannot be executed during an online module change. When using the dedicated instruction to execute save/restoration, therefore, execute save/restoration in the other system*.

If the other system is unavailable, execute restoration by performing write to the buffer memory.

* : If the module is mounted on the remote I/O station, execute save/restoration in the other system mounted on the main base unit. (Save/restoration cannot be executed in the other system mounted on the remote I/O station.)

7.1 Online Module Change Conditions

The CPU, MELSECNET/H remote I/O module, Q64TD/Q64TDV-GH, GX Developer and base unit given below are needed to perform an online module change.

(1) CPU

The Process CPU is required.

For precautions for multiple CPU system configuration, refer to the QCPU User's Manual (Multiple CPU System).

(2) MELSECNET/H remote I/O module

The module of function version D or later is necessary.

(3) Q64TD/Q64TDV-GH

The module of function version C or later is necessary.

(4) GX Developer

GX Developer of Version 7.10L or later is necessary.

GX Developer of Version 8.18U or later is required to perform an online module change on the remote I/O station.

(5) Base unit

1) When the slim type main base unit (Q3□SB) is used, an online module change cannot be performed.

2) When the power supply module unnecessary type extension base unit (Q5□B) is used, online module change cannot be performed for the modules on all the base units connected.

7.2 Online Module Change Operations

The following gives the operations performed for an online module change.

CPU operation ○: Executed ×: Not executed						(User operation)	(Intelligent function module operation)
X/Y refresh	FROM/TO instruction * 1	Dedicated instruction	Device test	GX Configurator			
				Initial setting parameter	Monitor/test		
○	○	○	○	×	○	<p>(1) Conversion disable</p> <p>Turn OFF all Y signals that were turned ON by a sequence program.</p> <p>(2) Dismounting of module</p> <p>Operate GX Developer to start an online module change.</p> <p>Click the [Execution] button of GX Developer to make the module dismountable.</p> <p>Dismount the corresponding module.</p> <p>(3) Mounting of new module</p> <p>Mount a new module.</p> <p>After mounting the module, click the [Execution] button of GX Developer.</p> <p>Operation check before control start</p> <p>(4) Operation check</p> <p>Click the [Cancel] button of GX Developer to leave the online mode.</p> <p>Conduct an operation test on the new module using "Device test" of GX Developer or "Monitor/test" of GX Configurator.</p> <p>Perform user range restoration processing by write to buffer memory at this point.</p> <p>Operation check completed</p> <p>(5) Resumption of control</p> <p>Operate GX Developer to resume the online module change mode, and click the [Execution] button to resume control.</p>	<p>Module is operating as usual.</p> <p>Module stops operating.</p> <ul style="list-style-type: none"> • RUN LED turns off. • Conversion disabled. <p>X/Y refresh resumes and the module starts.</p> <ul style="list-style-type: none"> • RUN LED turns on. • Default operation (X0 remains OFF) <p>When there are initial setting parameters, operation is performed according to the initial setting parameters at this point.</p> <p>Module operates according to test operation *2</p> <p>X0 (Module Ready) turns ON.</p> <p>Start is made when X0 turns from OFF to ON. Operation is performed according to the initial setting sequence.*2</p>
×	×	×	×	×	×		
○	×	×	×	○	×		
○	×	×	○	×	○		
○	○	○	○	×	○		

* 1: Access to the intelligent function module device (U□G□) is included.

* 2: In the absence of the operation marked * 2, the operation of the intelligent function module is the operation performed prior to that.

7.3 Online Module Change Procedure

There are the following online module change procedures depending on whether the user range setting has been made or not, whether the initial setting of GX Configurator-TI has been made or not, and whether the other system exists or not.

Range setting	Initial setting	Other system	Reference section
Factory setting	GX Configurator-TI	—	Section 7.3.1
Factory setting	Sequence program	—	Section 7.3.2
User range setting	GX Configurator-TI	Present	Section 7.3.3
User range setting	GX Configurator-TI	Absent	Section 7.3.4
User range setting	Sequence program	Present	Section 7.3.5
User range setting	Sequence program	Absent	Section 7.3.6

7.3.1 When factory default is used and initial setting was made with GX Configurator-TI

(1) Conversion disable

- (a) Set conversion enable/disable setting (buffer memory address 0: Un\G0) for all channel conversion disable and turn Operating Condition Setting Request (Y9) from OFF to ON to stop conversion.

After confirming that conversion has stopped with the Conversion Completion Flag (buffer memory address 10: Un\G10), turn off Operating Condition Setting Request (Y9).

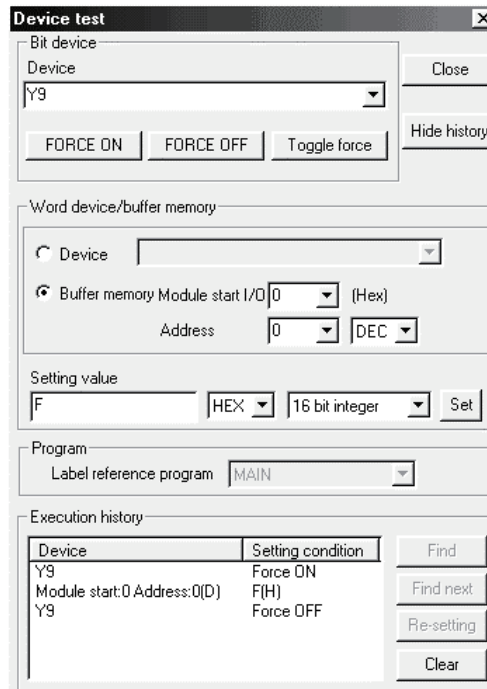

(2) Dismounting of module

- (a) After choosing [Diagnosis] - [Online module change] on GX Developer to enter the "Online module change" mode, double-click the module to be changed online to display the "Online module change" screen.

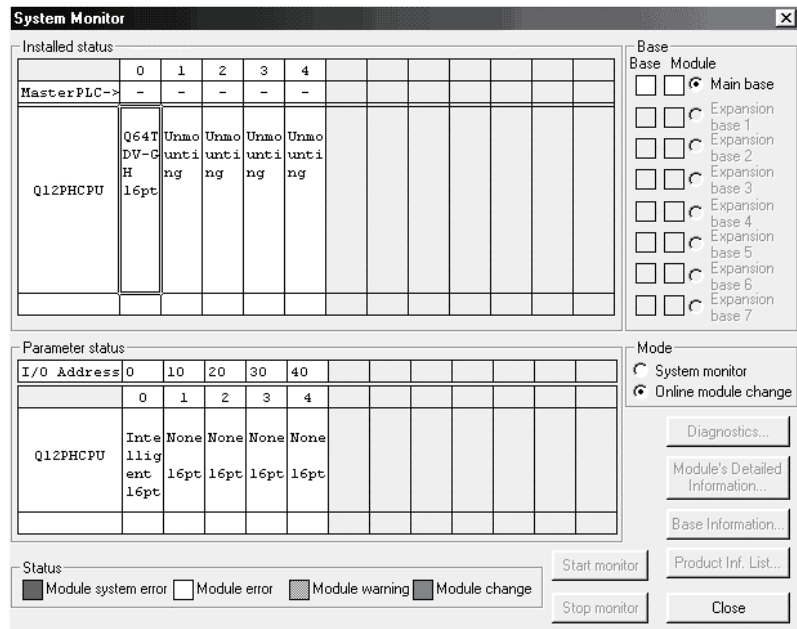

- (b) Click the "Execution" button to enable a module change.

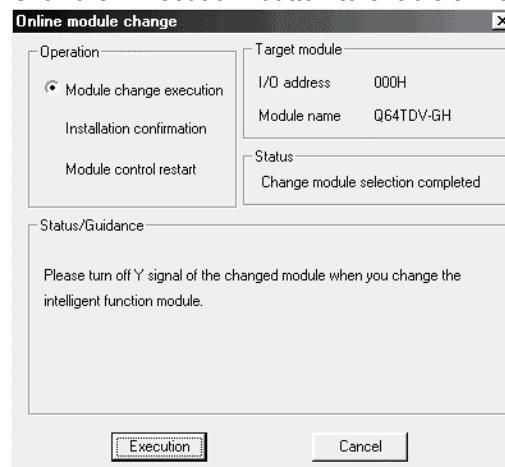

If the following error screen appears, click the [OK] button, dismount the module, and mount a new module.

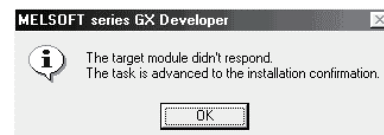

- (c) After confirming that the "RUN" LED of the module has turned off, remove the external wiring and dismount the module.

POINT

- (1) If you have removed the wiring together with the terminal block, the measured temperature values may vary within the accuracy range due to the error of the specific cold junction compensation resistor.
- (2) Always dismount the module. If you execute mounting confirmation without dismounting the module, the module will not start properly and the "RUN" LED will not be lit.

(3) Mounting of new module

- (a) Mount a new module to the same slot and install the external wiring.
- (b) After mounting the module, click the [Execution] button and make sure that the "RUN" LED is lit. Module Ready (X0) remains OFF.

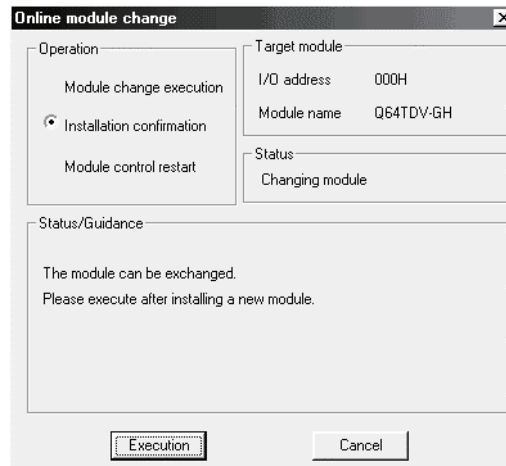

(4) Operation check

- (a) To make an operation check, click the [Cancel] button to cancel control resumption.

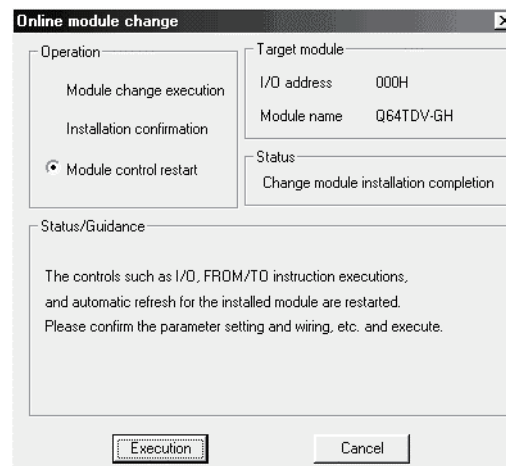

- (b) Click the [OK] button to leave the "Online module change" mode.

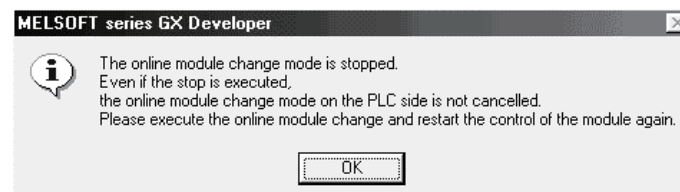

(c) Click the [Close] button to close the System monitor screen.

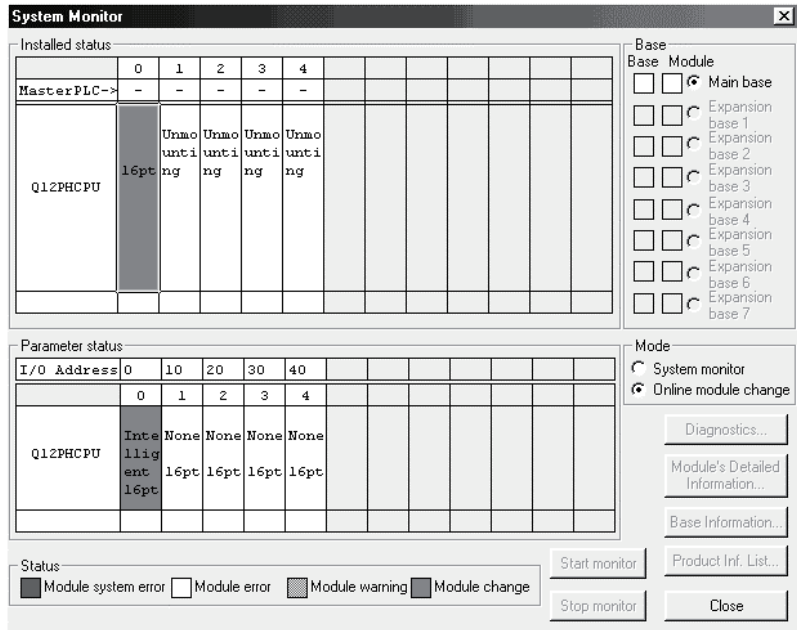

(d) Monitor the measured temperature value/micro voltage conversion value (buffer memory addresses 11 to 14: Un\G11 to 14) to check that proper conversion has been made.

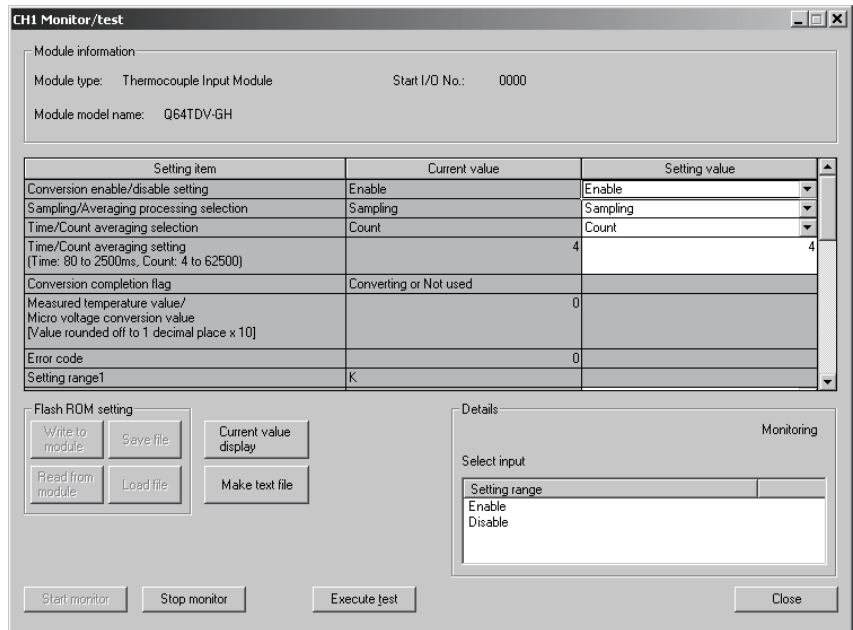

(5) Resumption of control

- (a) After choosing [Diagnosis] - [Online module change] on GX Developer to redisplay the "Online module change" screen, click the [Execution] button to resume control. The FROM/TO instruction for the module resumes.

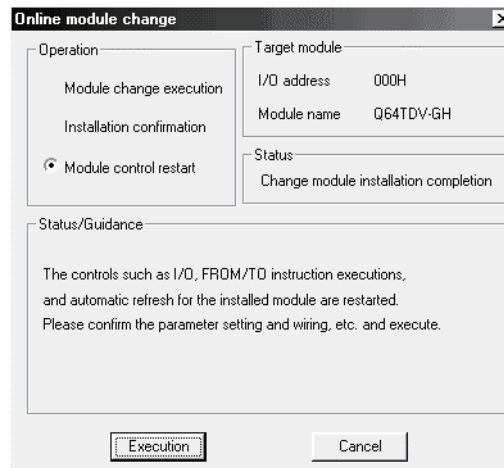

- (b) The "Online module change completed" screen appears.



7.3.2 When factory default is used and initial setting was made with sequence program

(1) Conversion disable

- (a) Set conversion enable/disable setting (buffer memory address 0: Un\G0) for all channel conversion disable and turn Operating Condition Setting Request (Y9) from OFF to ON to stop conversion.

After confirming that conversion has stopped with the Conversion Completion Flag (buffer memory address 10: Un\G10), turn off Operating Condition Setting Request (Y9).

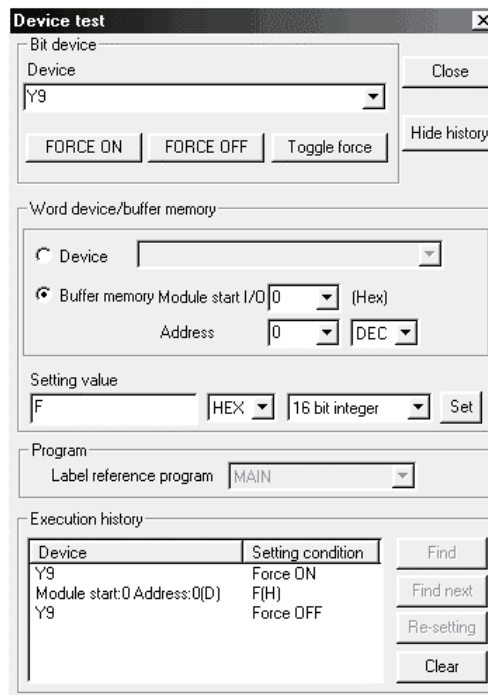

(2) Dismounting of module

- (a) After choosing [Diagnosis] - [Online module change] on GX Developer to enter the "Online module change" mode, double-click the module to be changed online to display the "Online module change" screen.

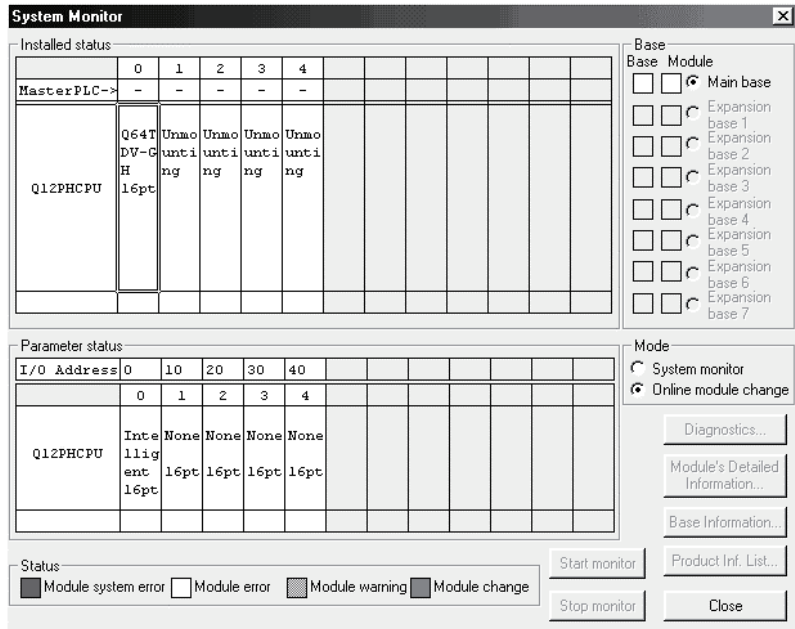

- (b) Click the "Execution" button to enable a module change.

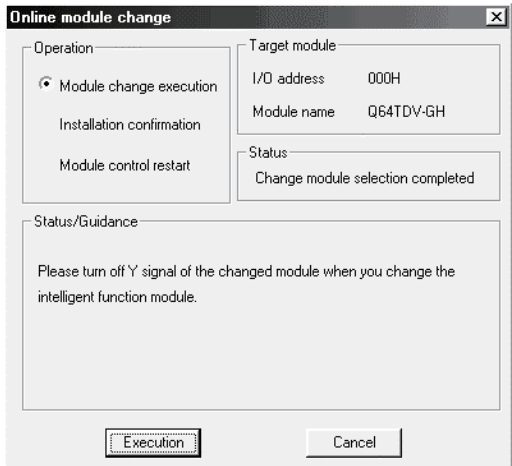

If the following error screen appears, click the [OK] button, dismount the module, and mount a new module.



- (c) After confirming that the "RUN" LED of the module has turned off, remove the external wiring and dismount the module.

POINT

- (1) If you have removed the wiring together with the terminal block, the measured temperature values may vary within the accuracy range due to the error of the specific cold junction compensation resistor.
- (2) Always dismount the module. If you execute mounting confirmation without dismounting the module, the module will not start properly and the "RUN" LED will not be lit.

(3) Mounting of new module

- (a) Mount a new module to the same slot and install the external wiring.
- (b) After mounting the module, click the [Execution] button and make sure that the "RUN" LED is lit. Module Ready (X0) remains OFF.

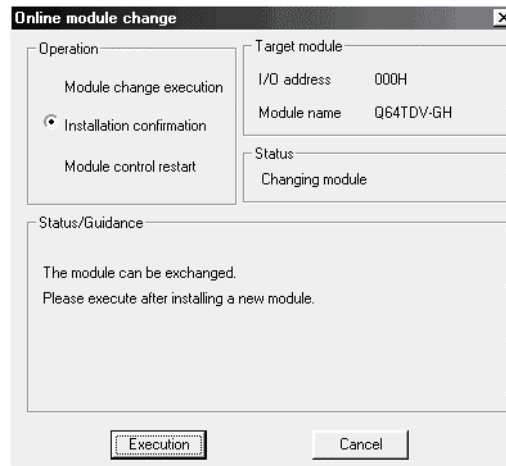

(4) Operation check

- (a) To make an operation check, click the [Cancel] button to cancel control resumption.

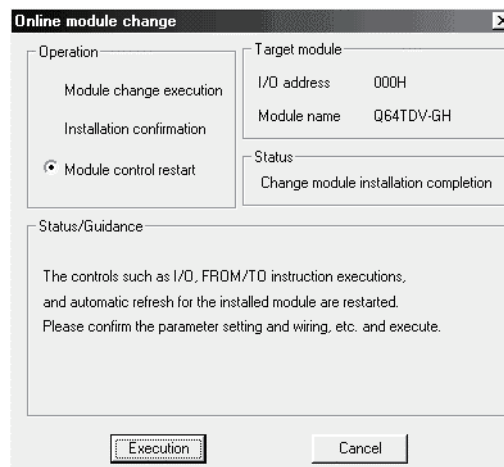

- (b) Click the [OK] button to leave the "Online module change" mode.

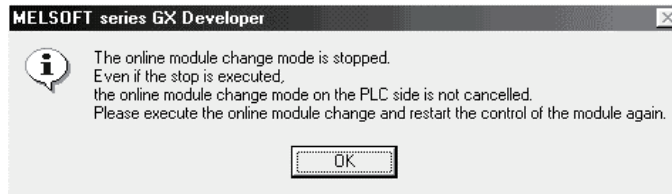

- (c) Click the [Close] button to close the System monitor screen.

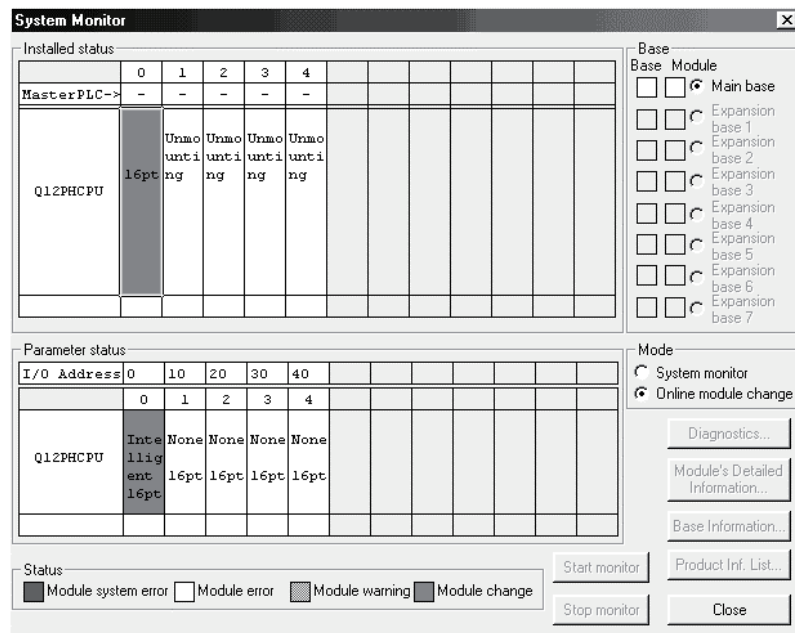

- (d) Referring to (1), enable the conversion of the channels to be used, and monitor the measured temperature value/micro voltage conversion value (buffer memory addresses 11 to 14: Un\G11 to 14) to check that proper conversion has been made.
- (e) Since the new module is in a default status, it must be initialized by a sequence program after control resumption. Before performing initialization, check whether the contents of the initialization program are correct or not.
 - 1) Normal system configuration

The sequence program should perform initialization on the leading edge of Module READY (X9) of the Q64TD/Q64TDV-GH. When control resumption is executed, Module READY (X0) turns ON and initialization is performed. (If the sequence program performs initialization only one scan after RUN, initialization is not performed.)
 - 2) When used on remote I/O network

Insert a user device that will execute initialization at any timing (initialization request signal) into the sequence program. After control resumption, turn ON the initialization request signal to perform initialization. (If the sequence program performs initialization only one scan after a data link start of the remote I/O network, initialization is not performed.)

(5) Resumption of control

- (a) After choosing [Diagnosis] - [Online module change] on GX Developer to redisplay the "Online module change" screen, click the [Execution] button to resume control. The FROM/TO instruction for the module resumes.

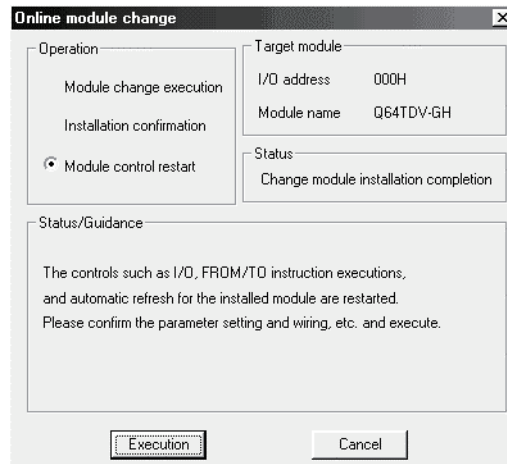

- (b) The "Online module change completed" screen appears.



7.3.3 When user range setting is used and initial setting was made with GX Configurator-TI (other system is available)

(1) Conversion disable

- (a) Set conversion enable/disable setting (buffer memory address 0: Un\G0) for all channel conversion disable and turn Operating Condition Setting Request (Y9) from OFF to ON to stop conversion.

After confirming that conversion has stopped with the Conversion Completion Flag (buffer memory address 10: Un\G10), turn off Operating Condition Setting Request (Y9).

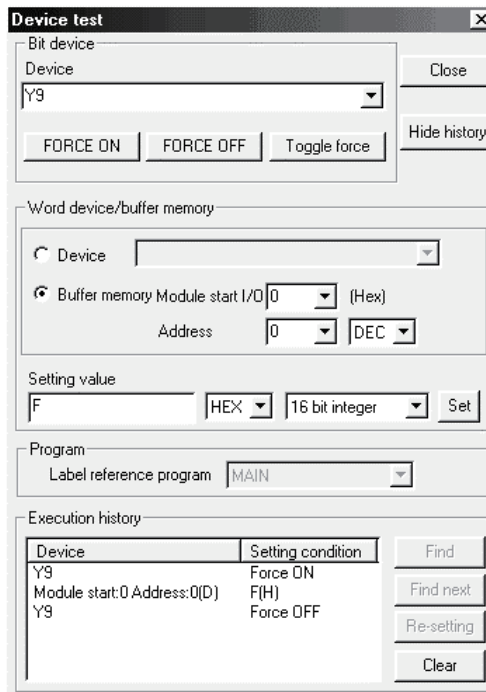

(2) Dismounting of module

- (a) After choosing [Diagnosis] - [Online module change] on GX Developer to enter the "Online module change" mode, double-click the module to be changed online to display the "Online module change" screen.

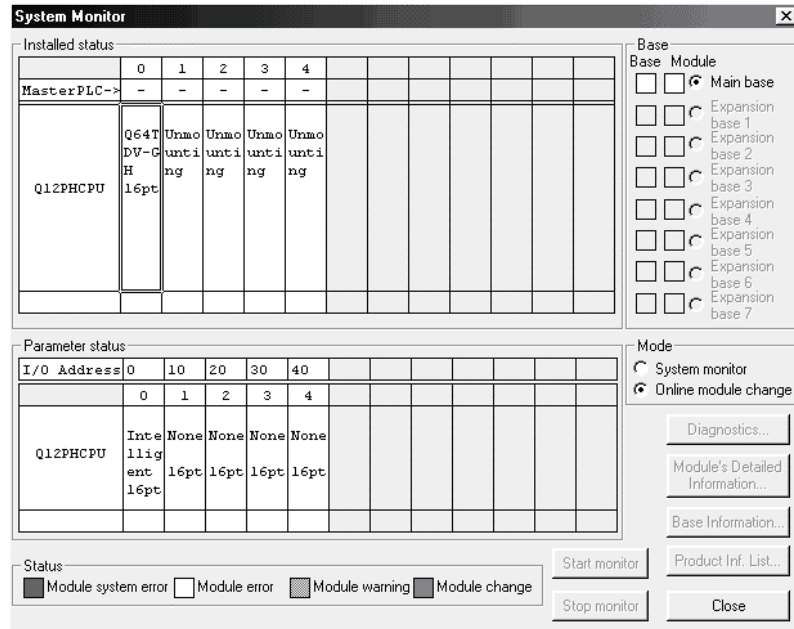

- (b) Click the "Execution" button to enable a module change.

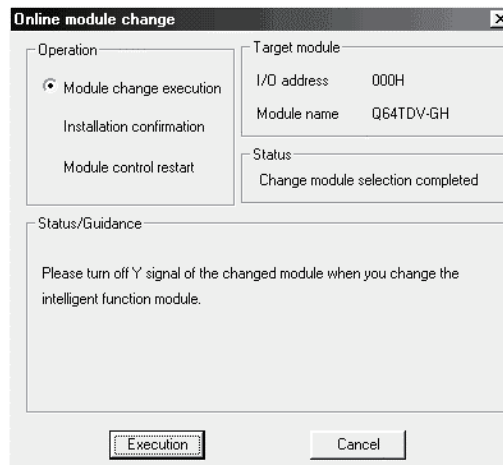

If the following error screen appears, the user range cannot be saved. Click the [OK] button, and perform the operation in Section 7.3.4 (2)(c) and later.

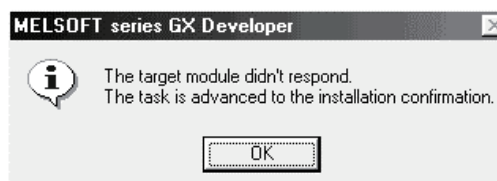

- (c) After confirming that the "RUN" LED of the module has turned off, remove the external wiring and dismount the module.

POINT

- | |
|--|
| <p>(1) If you have removed the wiring together with the terminal block, the measured temperature values may vary within the accuracy range due to the error of the specific cold junction compensation resistor.</p> <p>(2) Always dismount the module. If you execute mounting confirmation without dismounting the module, the module will not start properly and the "RUN" LED will not be lit.</p> |
|--|

(3) Mounting of new module

- (a) Mount the dismounted module and new module to the other system.
- (b) Using the G.OGLOAD instruction, save the user range setting values to the CPU device. Refer to Appendix 5.3 for the G.OGSTOR instruction.
- (c) Using the G.OGSTOR instruction, restore the user range setting values to the module. Refer to Appendix 5.4 for the G.OGSTOR instruction.
- (d) Dismount the new module from the other system, mount it to the slot from where the old module was dismounted in the original system, and install the external wiring.
- (e) After mounting the module, click the [Execution] button and make sure that the "RUN" LED is lit. Module Ready (X0) remains OFF.

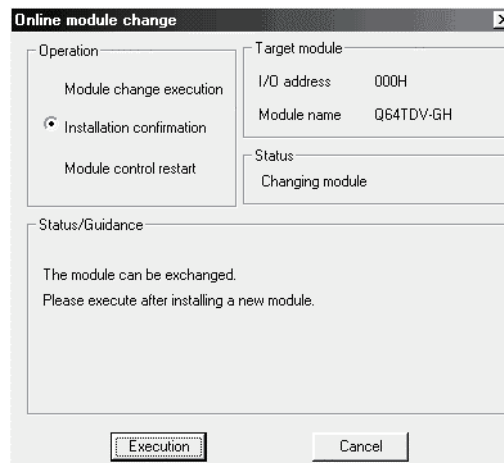

(4) Operation check

- (a) To make an operation check, click the [Cancel] button to cancel control resumption.

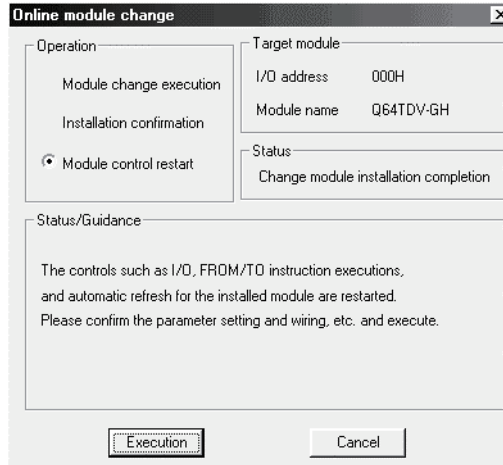

- (b) Click the [OK] button to leave the "Online module change" mode.

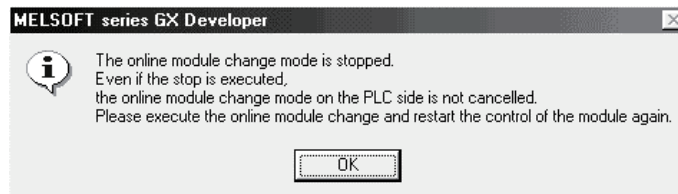

- (c) Click the [Close] button to close the System monitor screen.

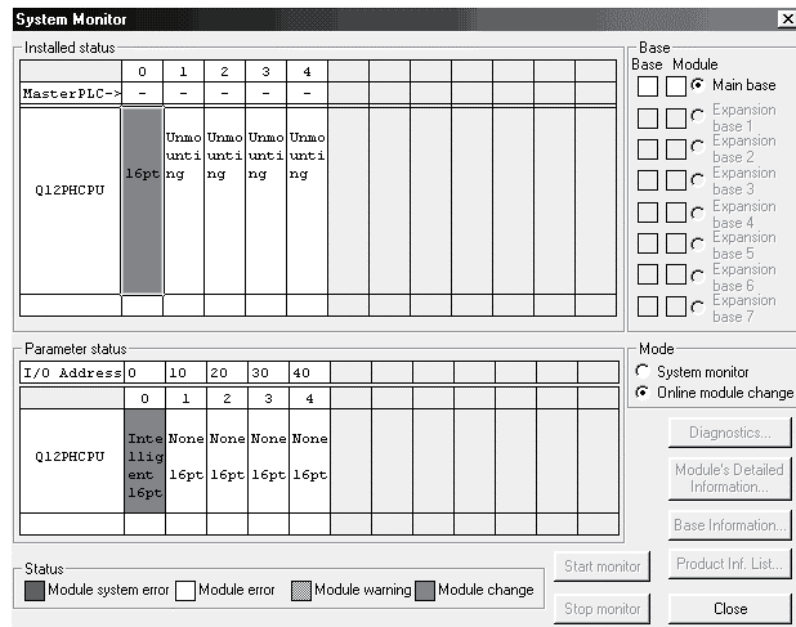

- (d) Monitor the measured temperature value/micro voltage conversion value (buffer memory addresses 11 to 14: Un\G11 to 14) to check that proper conversion has been made

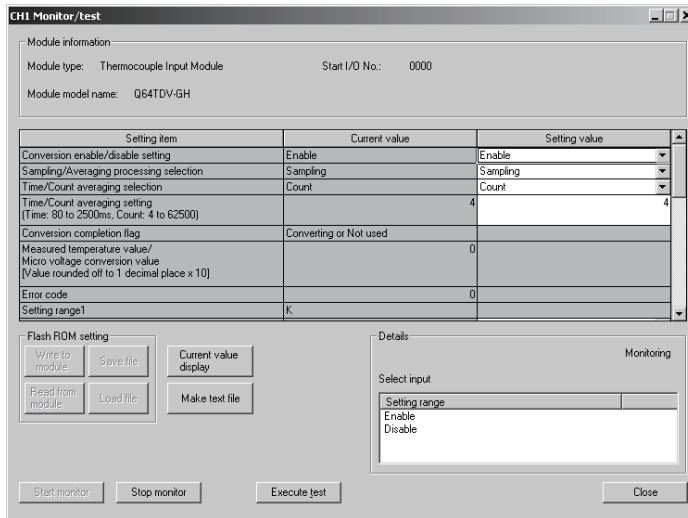

(5) Resumption of control

- (a) After choosing [Diagnosis] - [Online module change] on GX Developer to redisplay the "Online module change" screen, click the [Execution] button to resume control. The FROM/TO instruction for the module resumes.

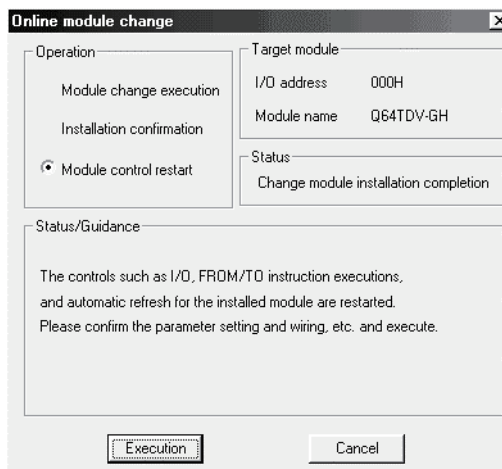

- (b) The "Online module change completed" screen appears.



7.3.4 When user range setting is used and initial setting was made with GX Configurator-TI (other system is unavailable)

(1) Conversion disable

- (a) Set "Disable" in the Setting value field of Conversion Enable/Disable Setting on the CH1 Monitor/Test screen of GX Configurator-TI, and click the **Execute test** button.

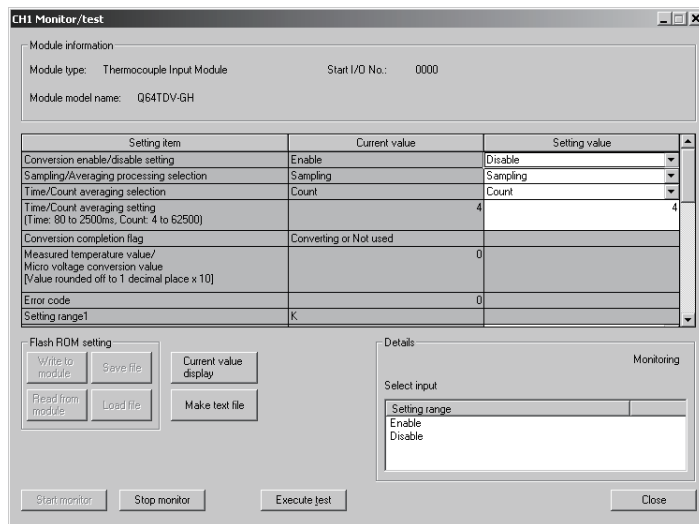

- (b) After making sure that "Disable" is displayed in the Current value field of Conversion Enable/Disable Setting, set "Request" in the Setting value field of Operation Condition Setting Request on the Monitor screen, and click the **Execute test** button to stop conversion.

Monitor the Conversion Completion Flag (buffer memory address 10: Un\G10) and confirm that conversion has stopped.

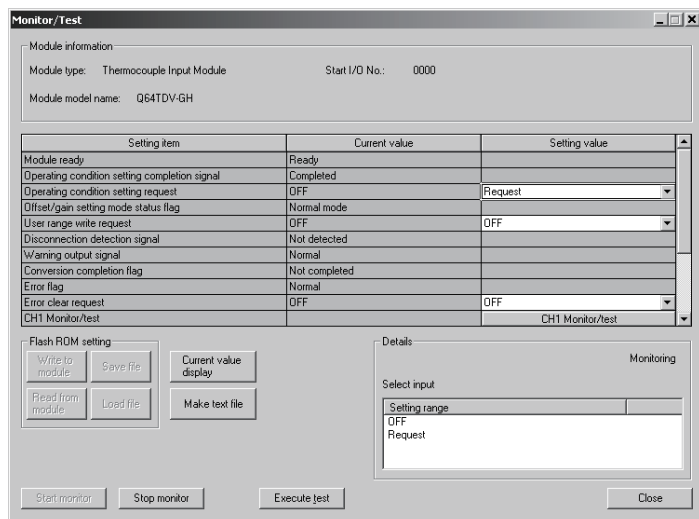

- (c) If the saved buffer memory contents are not yet prerecorded, record them in the following procedure.
 - 1) Display the OMC refresh data screen of GX Configurator-TI.
 - 2) Make a OMC refresh data read request. (Refer to Section 5.6.4)
 - 3) Compare the current values of the Factory default offset/gain value/User range settings offset/gain value/User range settings thermal EMF offset/gain value with those of the range reference table. Refer to Section 7.4 for the range reference table.
 - 4) If the values are proper, take a note of the Factory default offset/gain value/user range setting offset/gain value/user range settings thermal EMF offset/gain value

POINT

If the buffer memory values compared with the reference table are not proper, save and restoration of the user range cannot be executed.

Before executing module control resumption, make offset/gain setting in the GX Configurator-TI. (Refer to Section 5.6.2.)

Note that if module control is resumed without offset/gain setting being made, operation will be performed with the default values.

(2) Dismounting of module

- (a) After choosing [Diagnosis] - [Online module change] on GX Developer to enter the "Online module change" mode, double-click the module to be changed online to display the "Online module change" screen.

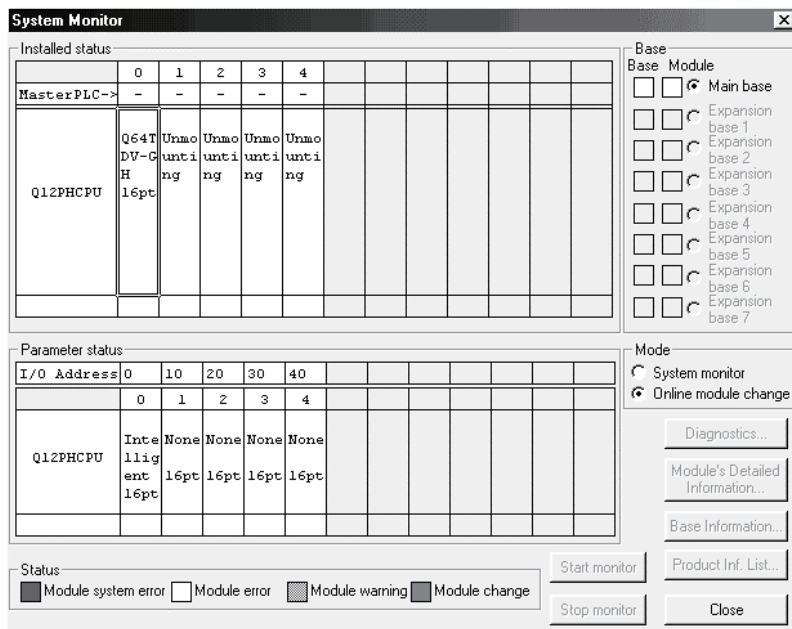

- (b) Click the "Execution" button to enable a module change.

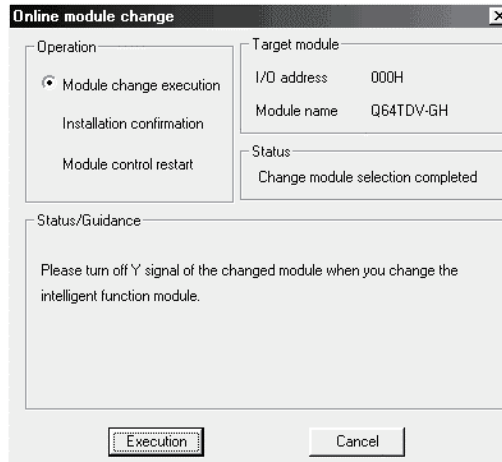

If the following error screen appears, the user range cannot be saved. Click the [OK] button, and perform the operation in Section (2)(c) and later.



- (c) After confirming that the "RUN" LED of the module has turned off, remove the external wiring and dismount the module.

POINT

- (1) If you have removed the wiring together with the terminal block, the measured temperature values may vary within the accuracy range due to the error of the specific cold junction compensation resistor.
- (2) Always dismount the module. If you execute mounting confirmation without dismounting the module, the module will not start properly and the "RUN" LED will not be lit.

(3) Mounting of new module

- (a) Mount a new module to the same slot and install the external wiring.
- (b) After mounting the module, click the [Execution] button and make sure that the "RUN" LED is lit. Module Ready (X0) remains OFF.

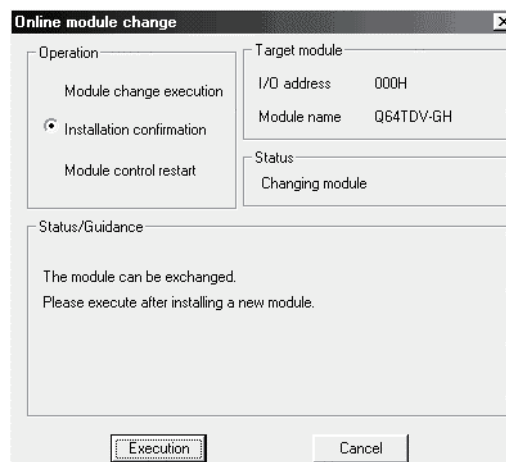

(4) Operation check

- (a) To make an operation check, click the [Cancel] button to cancel control resumption.

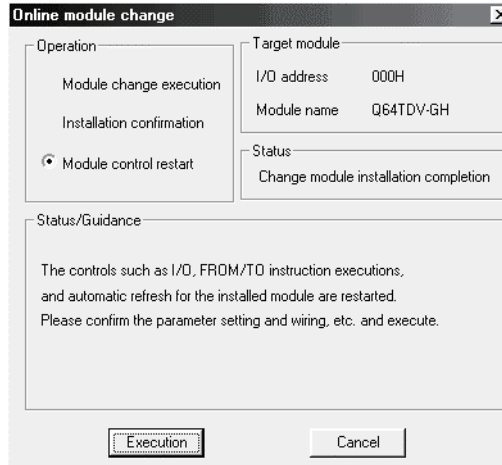

- (b) Click the [OK] button to leave the "Online module change" mode.

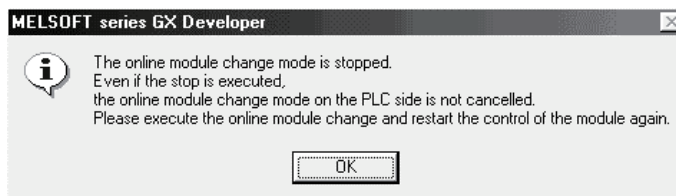

- (c) Click the [Close] button to close the System monitor screen.

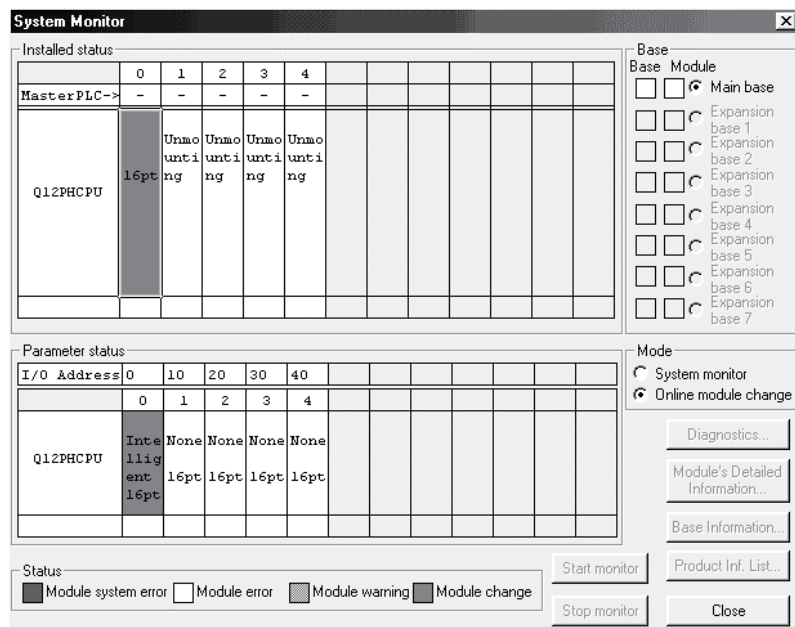

- (d) On the OMC refresh data screen of GX Configurator-TI, set the prerecorded values and make a OMC refresh data write request. (Refer to Section 5.6.4.)

- (e) Monitor the measured temperature value/micro voltage conversion value (buffer memory addresses 11 to 14: Un\G11 to 14) to check whether it is converted properly.

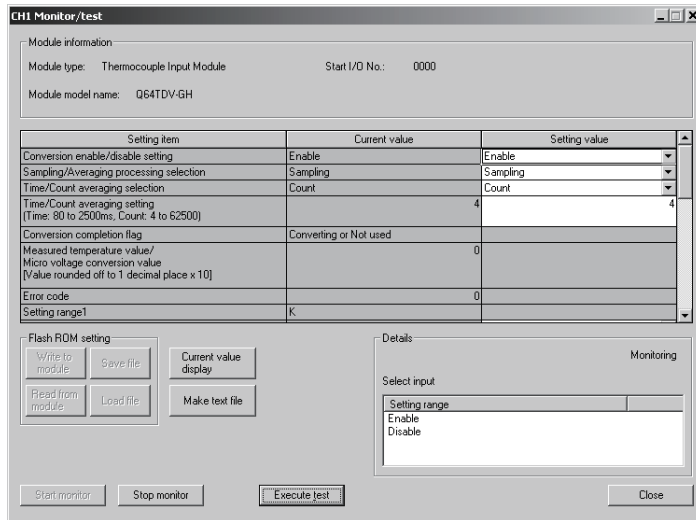

(5) Resumption of control

- (a) After choosing [Diagnosis] - [Online module change] on GX Developer to redisplay the "Online module change" screen, click the [Execution] button to resume control. The FROM/TO instruction for the module resumes.

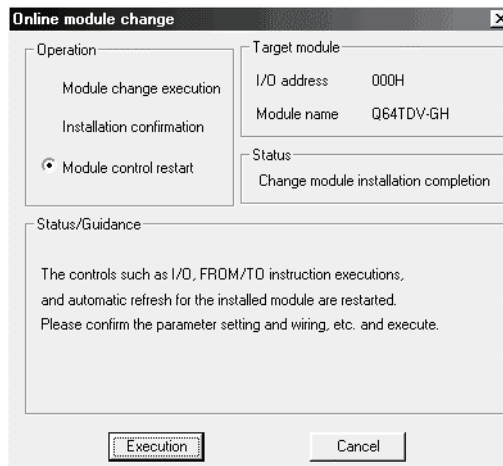

- (b) The "Online module change completed" screen appears.



7.3.5 When user range setting is used and initial setting was made with sequence program (other system is available)

(1) Conversion disable

- (a) Set conversion enable/disable setting (buffer memory address 0: Un\G0) for all channel conversion disable and turn Operating Condition Setting Request (Y9) from OFF to ON to stop conversion.

After confirming that conversion has stopped with the Conversion Completion Flag (buffer memory address 10: Un\G10), turn off Operating Condition Setting Request (Y9).

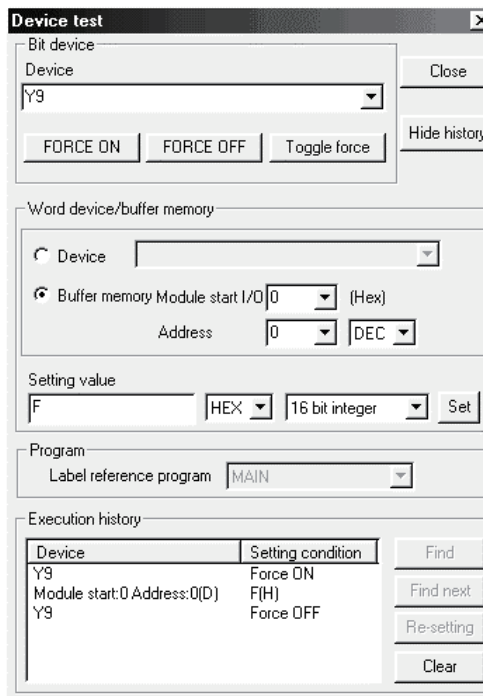

(2) Dismounting of module

- (a) After choosing [Diagnosis] - [Online module change] on GX Developer to enter the "Online module change" mode, double-click the module to be changed online to display the "Online module change" screen.

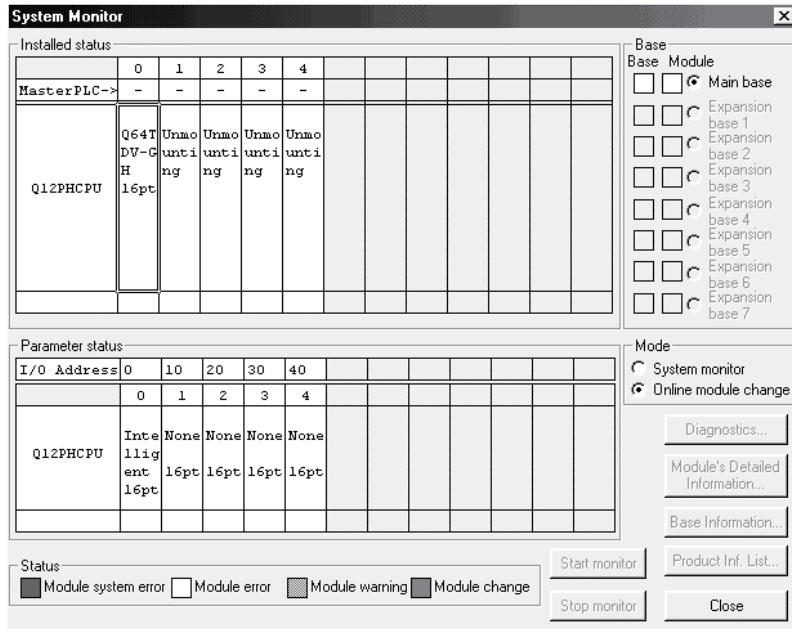

- (b) Click the "Execution" button to enable a module change.

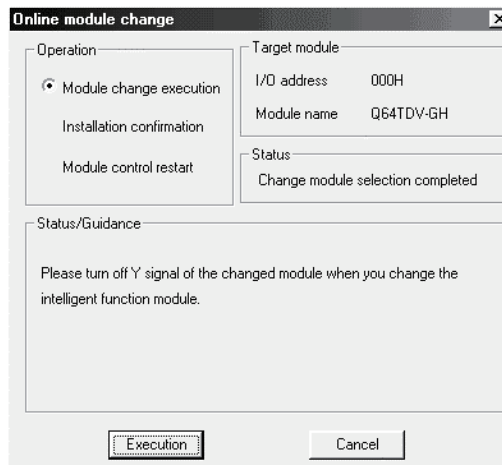

If the following error screen appears, the user range cannot be saved. Click the [OK] button, and perform the operation in Section 7.3.6 (2)(c) and later.

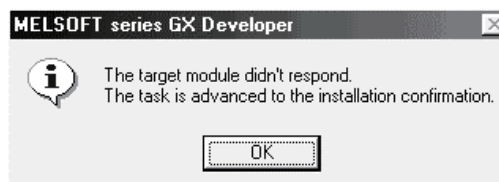

- (c) After confirming that the "RUN" LED of the module has turned off, remove the external wiring and dismount the module.

POINT

- | |
|---|
| <p>(1) If you have removed the wiring together with the terminal block, the temperature measurement values may vary within the accuracy range due to the error of the specific cold junction compensation resistor.</p> <p>(2) Always dismount the module. If you execute mounting confirmation without dismounting the module, the module will not start properly and the "RUN" LED will not be lit.</p> |
|---|

(3) Mounting of new module

- (a) Mount the dismounted module and new module to the other system.
- (b) Using the G(P).OGLOAD instruction, save the user range setting values to the CPU device. Refer to Appendix 5.3 for the G(P).OGLOAD instruction.
- (c) Using the G(P).OGSTOR instruction, restore the user range setting set values to the module. Refer to Appendix 5.4 for the G(P).OGSTOR instruction.
- (d) Dismount the new module from the other system, mount it to the slot from where the old module was dismounted in the original system, and install the external wiring.
- (e) After mounting the module, click the [Execution] button and make sure that the "RUN" LED is lit. Module Ready (X0) remains OFF.

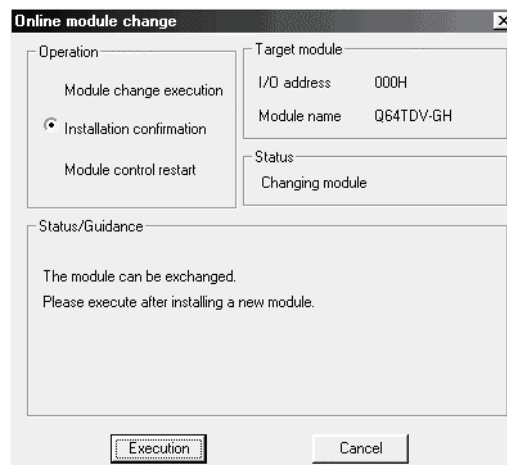

(4) Operation check

- (a) To make an operation check, click the [Cancel] button to cancel control resumption.

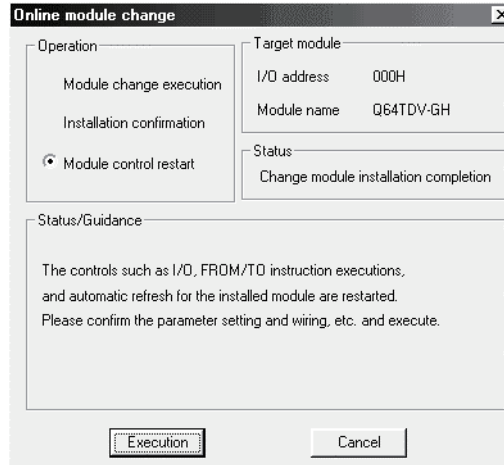

- (b) Click the [OK] button to leave the "Online module change" mode.

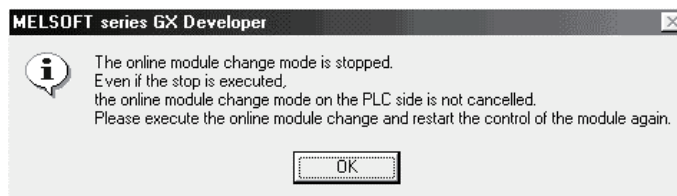

- (c) Click the [Close] button to close the System monitor screen.

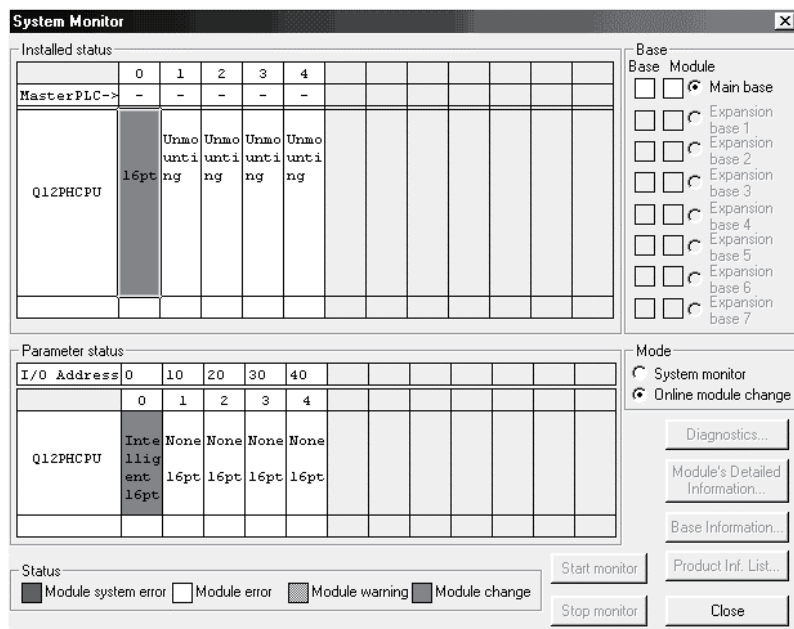

- (d) Referring to (1), enable the conversion of the channels to be used, and monitor the measured temperature value/micro voltage conversion value (buffer memory addresses 11 to 14: UnG11 to 14) to check that proper conversion has been made.

- (e) Since the new module is in a default status, it must be initialized by a sequence program after control resumption.
Before performing initialization, check whether the contents of the initialization program are correct or not.
- 1) Normal system configuration
The sequence program should perform initialization on the leading edge of Module READY (X9) of the Q64TD/Q64TDV-GH.
When control resumption is executed, Module READY (X0) turns ON and initialization is performed. (If the sequence program performs initialization only one scan after RUN, initialization is not performed.)
 - 2) When used on remote I/O network
Insert a user device that will execute initialization at any timing (initialization request signal) into the sequence program. After control resumption, turn ON the initialization request signal to perform initialization. (If the sequence program performs initialization only one scan after a data link start of the remote I/O network, initialization is not performed.)

(5) Resumption of control

- (a) After choosing [Diagnosis] - [Online module change] on GX Developer to redisplay the "Online module change" screen, click the [Execution] button to resume control. The FROM/TO instruction for the module resumes.

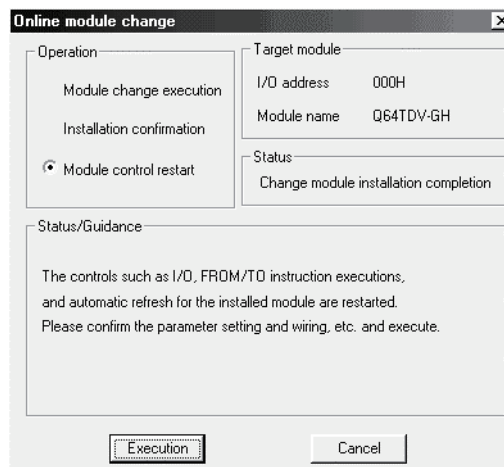

- (b) The "Online module change completed" screen appears.



7.3.6 When user range setting is used and initial setting was made with sequence program (other system is unavailable)

(1) Conversion disable

- (a) Set "Disable" in the conversion enable/disable setting (buffer memory address 0: Un\G0) for all channels and turn Operating Condition Setting Request (Y9) from OFF to ON to stop conversion.

After confirming that conversion has stopped with the Conversion Completion Flag (buffer memory address 10: Un\G10), turn off Operating Condition Setting Request (Y9).

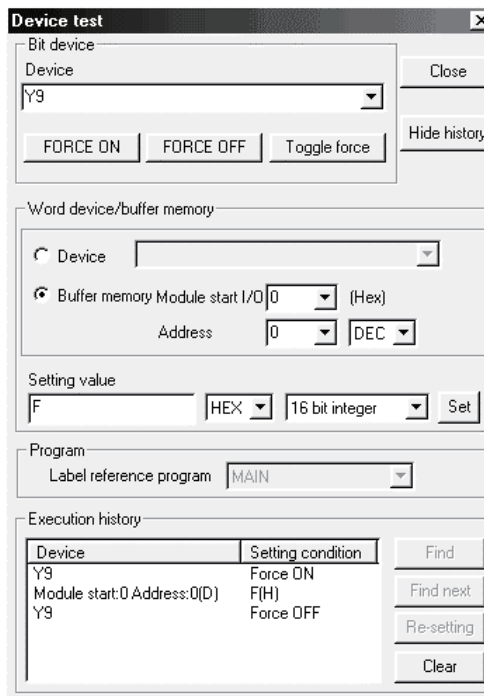

- (b) If the saved buffer memory contents are not yet prerecorded, record them in the following procedure.
- 1) Turn Operating Condition Setting Request (Y9) from OFF to ON.
 - 2) Compare the Factory default offset/gain value/User range settings offset/gain value/User range settings thermal EMF offset/gain value (buffer memory addresses 160 to 191: Un\G160 to Un\G191) with the range reference table. Refer to Section 7.4 for the range reference table.
 - 3) If the values are proper, take a note of them.

POINT

If the buffer memory values compared with the reference table are not proper, save and restoration of the user range cannot be executed. Before executing module control resumption, follow the flowchart in Section 4.6 and make offset/gain setting in the device test of GX Developer. Perform mode switching by making the setting of the mode switching setting (buffer memory addresses 158, 159: Un\G158, Un\G159) and turning Operating Condition Setting Request (Y9) from OFF to ON. Note that if module control is resumed without offset/gain setting being made, operation will be performed with the default values.

(2) Dismounting of module

- (a) After choosing [Diagnosis] - [Online module change] on GX Developer to enter the "Online module change" mode, double-click the module to be changed online to display the "Online module change" screen.

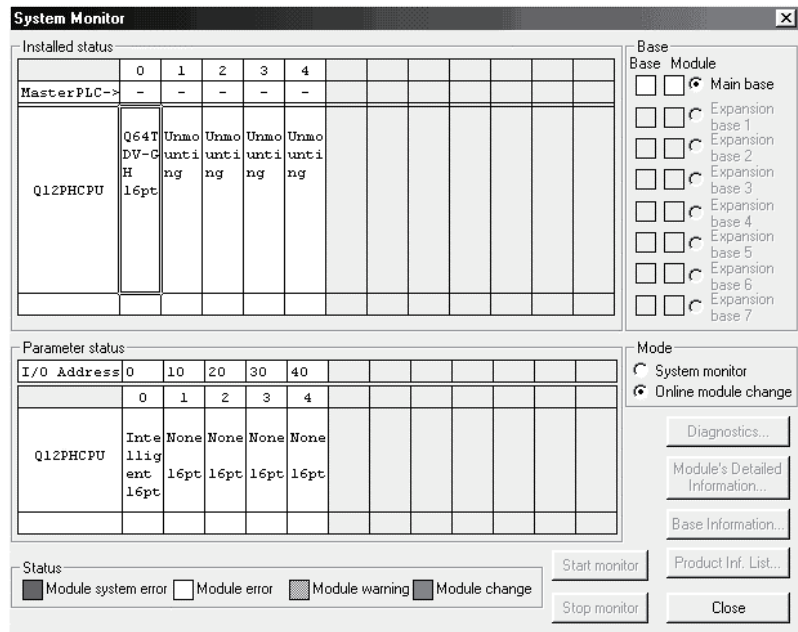

- (b) Click the "Execution" button to enable a module change.

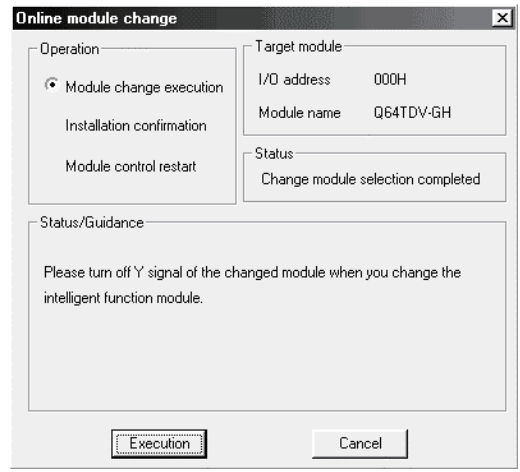

If the following error screen appears, the user range cannot be saved. Click the [OK] button, and perform the operation in Section (2)(c) and later.



- (c) After confirming that the "RUN" LED of the module has turned off, remove the external wiring and dismount the module.

POINT

- (1) If you have removed the wiring together with the terminal block, the measured temperature values may vary within the accuracy range due to the error of the specific cold junction compensation resistor.
- (2) Always dismount the module. If you execute mounting confirmation without dismounting the module, the module will not start properly and the "RUN" LED will not be lit.

(3) Mounting of new module

- (a) Mount a new module to the same slot and install the external wiring.
- (b) After mounting the module, click the [Execution] button and make sure that the "RUN" LED is lit. Module Ready (X0) remains OFF.

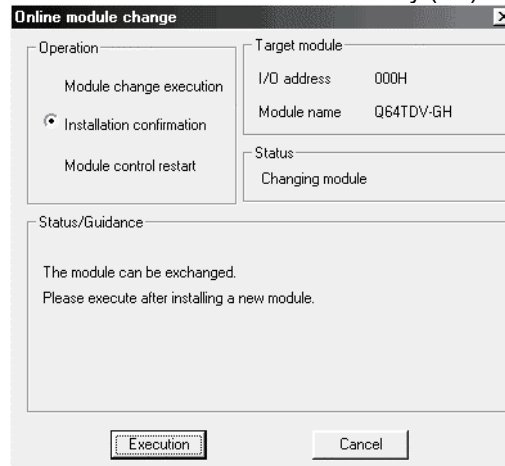

(4) Operation check

- (a) To make an operation check, click the [Cancel] button to cancel control resumption.

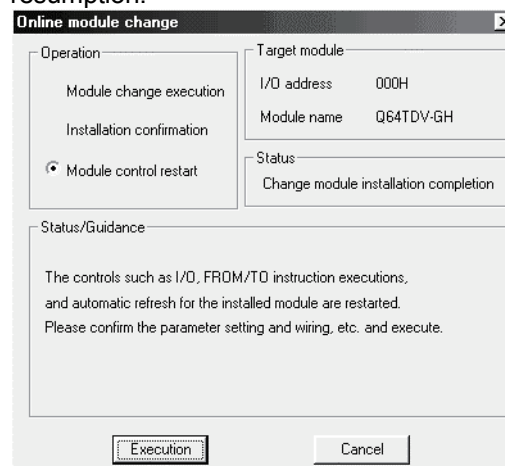

- (b) Click the [OK] button to leave the "Online module change" mode.

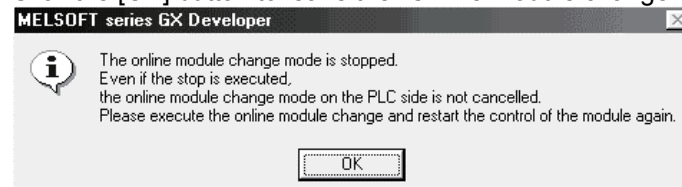

- (c) Click the [Close] button to close the System monitor screen.

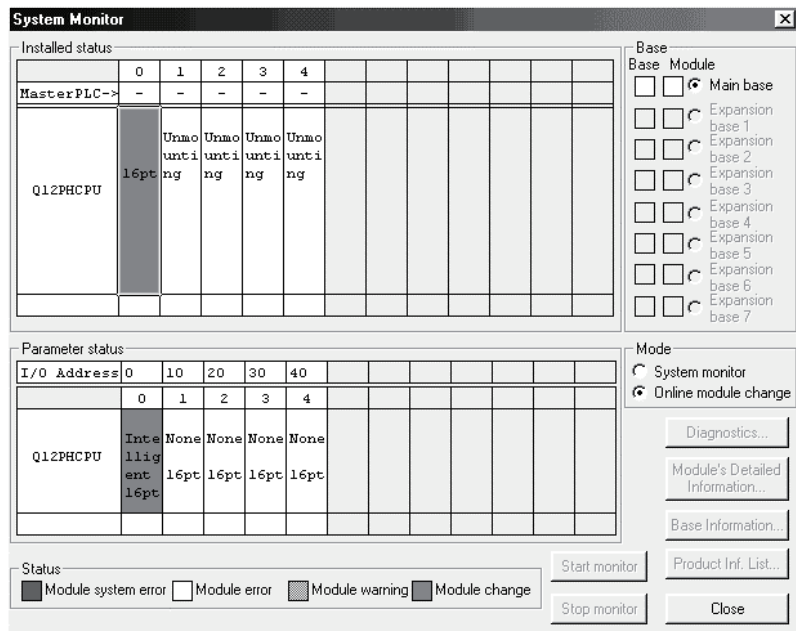

- (d) Choose [Online] - [Debug] - [Device test] on GX Developer and set the values prerecorded in Section (2) to the buffer memory.
- (e) Turn the user range write request (YA) from OFF to ON to restore the user set values to the module.
After confirming that the offset/gain setting mode status flag (XA) is ON, turn OFF the user range write request (YA).
- (f) Referring to (1), enable the conversion of the channel to be used, and monitor the measured temperature value/micro voltage conversion value (buffer memory addresses 11 to 14: Un\G11 to 14) to check that proper conversion has been made.
- (g) Since the new module is in a default status, it must be initialized by a sequence program after control resumption.
Before performing initialization, check whether the contents of the initialization program are correct or not.
- 1) Normal system configuration
The sequence program should perform initialization on the leading edge of Module READY (X9) of the Q64TD/Q64TDV-GH.
When control resumption is executed, Module READY (X0) turns ON and initialization is performed. (If the sequence program performs initialization only one scan after RUN, initialization is not performed.)
 - 2) When used on remote I/O network
Insert a user device that will execute initialization at any timing (initialization request signal) into the sequence program. After control resumption, turn ON the initialization request signal to perform initialization. (If the sequence program performs initialization only one scan after a data link start of the remote I/O network, initialization is not performed.)

(5) Resumption of control

- (a) After choosing [Diagnosis] - [Online module change] on GX Developer to redisplay the "Online module change" screen, click the [Execution] button to resume control. The FROM/TO instruction for the module resumes.

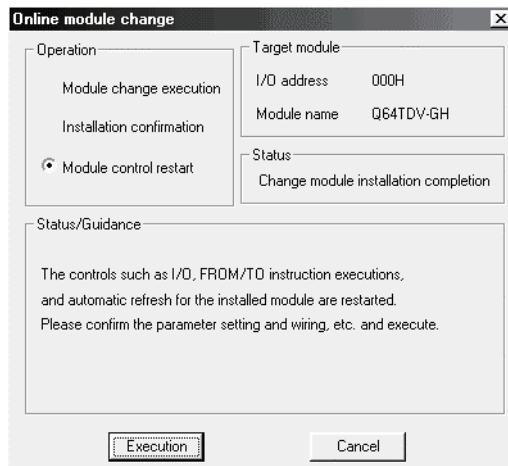

- (b) The "Online module change completed" screen appears.



7.4 Range Reference Table

The range reference tables are given below.

Address (Decimal)				Description	Reference value
CH1	CH2	CH3	CH4		
160	168	176	184	Factory default offset value	Digital offset value set prior to shipment (theoretical value 8000H)
161	169	177	185	Factory default gain value	Digital gain value set prior to shipment (theoretical value EB85 H)
162	170	178	186	User range settings offset value	Digital value for user-set offset value (*2)
163	171	179	187	User range settings gain value	Digital value for user-set gain value (*3)
164	172	180	188	User range settings thermal EMF (L)	Thermoelectromotive force or offset set voltage for user-set offset set temperature (μV unit) (*1)
165	173	181	189	offset value (H)	
166	174	182	190	User range settings thermal EMF (L)	Thermoelectromotive force or gain set voltage for user-set gain set temperature (μV unit) (*1)
167	175	183	191	gain value (H)	

*1: Refer to Appendix 3 for the thermal EMF.

*2: Use the following expression to calculate the theoretical value of the digital value.
 Digital value = User range settings thermal EMF offset value (μV) \times 0.65536 + 10922

*3: Use the following expression to calculate the theoretical value of the digital value.
 Digital value = User range settings thermal EMF gain value (μV) \times 0.65536 + 10922

(Example) When offset/gain setting is made at the offset set temperature of -200.0°C and the gain set temperature of 900.0°C with an E type thermocouple connected

Value type	Set temperature	Thermal EMF	Set value	Input value
Offset value	-200.0°C	$-8825 \mu\text{V}$	8825	$-8825 \times 0.65536 + 10922 = 5138$
Gain value	900.0°C	$68787 \mu\text{V}$	68787	$68787 \times 0.65536 + 10922 = 56002$

7.5 Precautions for Online Module Change

The following are the precautions for online module change.

- (1) Always perform an online module change in the correct procedure. A failure to do so can cause a malfunction or failure.
- (2) If an online module change is made with the user range setting, the accuracy after that will fall to about less than 1/3 of the accuracy before that.
 Re-set the offset/gain values as necessary.

8 TROUBLESHOOTING

This chapter explains the natures of errors which may occur during use of the Q64TD/Q64TDV-GH and troubleshooting.

8.1 Error Code List

If an error occurs during reading/writing data from/to a programmable controller CPU, the Q64TD/Q64TDV-GH writes the corresponding error code to the buffer memory address 19 (Un\G19).

Error Code (Decimal)	Description	Remedy
10□	The input type setting is other than 0 to 7 (Q64TD)/0 to 8 (Q64TDV-GH) in the intelligent function module switch setting. □ indicates the channel number set incorrectly.	Make a correct setting in the intelligent function module switch setting. (Refer to Section 4.5.)
111	A module error at a start.	Switch power off, then on again. If the error recurs, the module may have failed. Consult the Mitsubishi office.
12□	The offset/gain setting is other than 0 and 1 in the intelligent function module switch setting. □ indicates the channel number set incorrectly.	Make a correct setting in the intelligent function module switch setting. (Refer to Section 4.5.)
161 * 1	The G(P).OGSTOR instruction was executed in the offset/gain setting mode.	Do not execute the G(P).OGSTOR instruction in the offset/gain setting mode.
162	<ul style="list-style-type: none"> The G(P).OGSTOR instruction was executed consecutively. At the time of offset/gain setting, a set value was written to the E²PROM 26 or more times. 	<ul style="list-style-type: none"> Execute the G(P).OGSTOR instruction only once for one module. At the time of offset/gain setting, write a set value only once at one time.
163	<ul style="list-style-type: none"> The G(P).OGSTOR instruction was executed for the model that differs from the model for which the G(P).OGLOAD instruction had been executed. The G(P).OGSTOR instruction had been executed before the G(P).OGLOAD instruction was executed. 	Execute the G(P).OGLOAD and G(P).OGSTOR instructions for the same model.
20□	The averaging time setting is outside the setting range. □ indicates the channel number set incorrectly.	Set a correct value at the buffer memory address 1 to 4 (Un\G1 to 4). (Refer to Section 3.4.4.)
30□	The averaging count setting is outside the setting range. □ indicates the channel number set incorrectly.	Set a correct value at the buffer memory address 1 to 4 (Un\G1 to 4). (Refer to Section 3.4.4.)
40□	Gain value - offset value ≤ 0.1 [°C] (for temperature input) or gain value - offset value ≤ 4 [μ V] (for micro voltage input). □ indicates the channel number set incorrectly.	Set a correct value in buffer memory, or measure and check the voltage at the thermocouple/micro voltage input terminal.
50□	When the offset setting request (Y1, Y3, Y5, Y7) or gain setting request (Y2, Y4, Y6, Y8) is turned on in the offset/gain setting mode, the offset/gain of the intelligent function module switch setting on that channel is not user range setting. □ indicates the channel number set incorrectly.	Make a correct setting in the intelligent function module switch setting. (Refer to Section 4.5.)
51□	When the offset setting request (Y1, Y3, Y5, Y7) or gain setting request (Y2, Y4, Y6, Y8) is turned on in the offset/gain setting mode, the "offset value" or "gain value" of that channel is outside the measured range. □ indicates the channel number set incorrectly.	Check the measured range and set the offset/gain value within the range. (Refer to Section 3.1.1, 3.1.2.)
52□	The offset setting request and gain setting request were turned on simultaneously in the offset/gain setting mode. □ indicates the channel number set incorrectly.	Reexamine the sequence program so that they do not turn on simultaneously.
6△□	The warning output upper/lower limit value setting is outside the measurable range specified for the input type. □ indicates the channel number set incorrectly. △ indicates any of the following statuses. 0: The lower lower limit value is lower than the measurement range. 1: The upper upper limit value is higher than the measurement range. 2: Lower lower limit value > lower upper limit value 3: Lower upper limit value > upper lower limit value 4: Upper lower limit value > upper upper limit value	Set a correct value at the buffer memory address 86 to 101 (Un\G86 to 101). (Refer to Section 3.4.18.)

*1: Not written to the buffer memory address 19 (Un\G19). Written to the completion status area (S)+1 of the G(P).OGSTOR instruction.

POINT
<ul style="list-style-type: none"> • For the Q64TD, the code of the first error found by the Q64TD is stored when two or more errors occur. The latter errors are not stored. In addition, the error is cleared by mode switching. • For the Q64TDV-GH, the code of the latest error found by the Q64TDV-GH is stored when two or more errors occur. • The error can be cleared by turning on the error clear request (YF).

8.2 Troubleshooting

8.2.1 RUN LED is extinguished

Check Item	Remedy
Check that power is supplied.	Confirm that the supply voltage of the power supply module is within the rated range.
Check that the capacity of the power supply module is sufficient.	Calculate the current consumption of the CPU, I/O, intelligent function and other modules loaded on the base unit, and make sure that the power supply capacity is enough.
Check for a watchdog timer error.	Reset the programmable controller CPU and verify that it is lit. If the RUN LED does not light even after doing this, the module may be malfunctioning. Contact the nearest distributor or branch office with a description of the problem.
Check whether the modules are loaded normally on the base unit.	Check the module loading status.
Is a module change enabled during an online module change?	Refer to Chapter 7 and take corrective action.

8.2.2 RUN LED flickers

Check Item	Remedy
Check whether the module is in the offset/gain setting mode or not.	After making offset/gain setting, return to the normal mode.

8.2.3 ERROR LED flickers

Check Item	Remedy
Check whether the switch 5 of the intelligent function module switches is "other than 0".	Set the switch 5 of the intelligent function module switches for 0. (Refer to Section 4.5)

8.2.4 ERROR LED is lit

Check Item	Remedy
Check for an error.	Check the error code and take the action given in Section 8.1.

8.2.5 Disconnection detection flag (XC) has turned on

Check Item	Remedy
Check whether the thermocouple, compensation conductor or micro voltage signal cable is connected incompletely or not.	Connect the thermocouple, compensation conductor or micro voltage signal cable securely.
Check for loose terminal screws.	Retighten the terminal screws within the specified torque range.
Check the connected thermocouple, compensation conductor or micro voltage signal cable for wire break.	Make continuity check on the thermocouple, compensation conductor or micro voltage signal cable, and change the thermocouple, compensation conductor or micro voltage signal cable if its wire is broken.
Check whether the channel where no thermocouple or micro voltage signal cable is connected is set to conversion enable.	Check the channels which are set to conversion enable and the channels where thermocouples or micro voltage signal cables are connected, and set to conversion enable correctly.

8.2.6 Measured temperature value/micro voltage conversion value cannot be read

Check Item	Remedy
Check whether the used channel has been set for conversion disable.	Set it for conversion enable in sequence program.
Check whether the programmable controller CPU is set for STOP.	Set the programmable controller CPU for RUN.

8.2.7 Measured temperature value is abnormal

Check Item	Remedy
Check whether the connected thermocouple or compensation conductor differs from the setting.	Set the thermocouple type connected to the switch 1 in the intelligent function module switch setting.
Check whether the connected thermocouple or compensation conductor is connected reversely.	Connect the thermocouple or compensation conductor correctly.
Check for noise in the thermocouple input.	Check influence from the ground and adjacent devices, and take action to prevent noise.
Check the Pt100 temperature-measuring resistor for making cold junction temperature compensation for wire break or disconnection from the terminal block.	Confirm that the Pt100 temperature-measuring resistor is connected to the terminal block and there is continuity, and if not, connect or change the Pt100 temperature-measuring resistor.
Check whether the cold junction temperature compensation yes/no setting is correct.	Set the switch 4 to the correct position in the intelligent function module switch setting. (Refer to Section 4.5)
Check whether conversion is made with the other thermocouple set after setting of the offset/gain value	Make offset/gain setting again after changing the thermocouple.

8.2.8 Micro voltage conversion value is abnormal

Check Item	Remedy
Check whether the input type set is a thermocouple or not.	Set the switch for micro voltage input in the intelligent function module switch setting.
Check the micro voltage signal cable for noise.	Check influence from grounding and adjacent equipment, and take noise reduction measures.
After offset/gain value setting, the other signal cable was connected.	Make offset/gain setting again with the newly connected signal cable.

8.2.9 Checking the Q64TD/Q64TDV-GH status using GX Developer system monitor

When the Q64TD/Q64TDV-GH detail information is selected in GX Developer system monitor, error code can be checked.

(1) Operating GX Developer

[Diagnostics] → [System monitor] → "Select Q64TD/Q64TDV-GH" →

Module Detailed Information

(2) Module Detail Information

(a) Checking the function version and product information

The function version and product information of the Q64TD/Q64TDV-GH is displayed in the product information field.

(b) Checking the error code

The error code stored in buffer memory address 19 (Un\G19) of the Q64TD/Q64TDV-GH is displayed in the Present Error field.

(When the Error History button is pressed, the contents displayed in the Present Error field are displayed in the No. 1 field.)

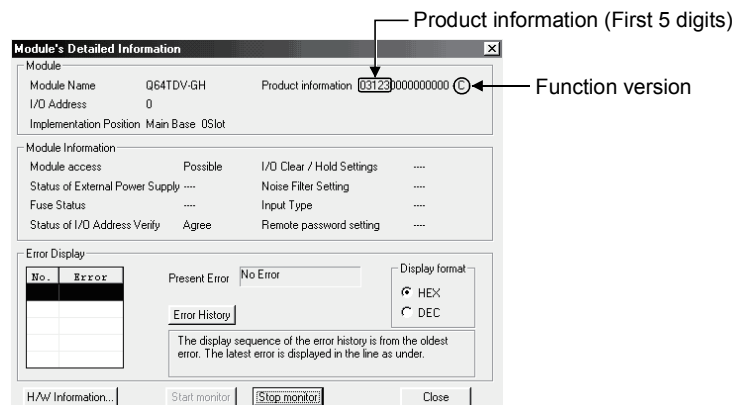

(3) H/W information

(a) H/W LED information

The LED ON status is displayed.

No.	LED name	Status
1	RUN LED	0000 _H : Indicates that LED is unlit.
2	ERROR LED	0001 _H : Indicates that LED is lit

(b) H/W SW information

The status of the intelligent function module switch setting is displayed.

No.	Switch setting for intelligent function module
1	Switch 1
2	Switch 2
3	Switch 3
4	Switch 4
5	Switch 5

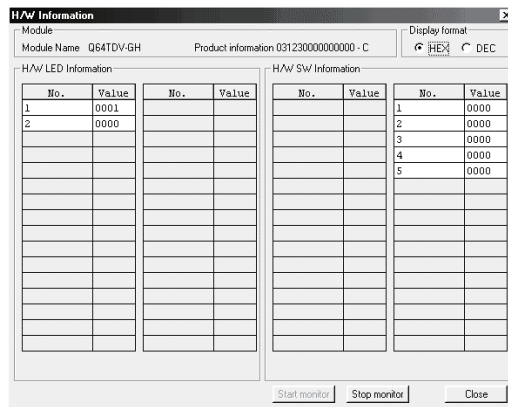

APPENDIX

Appendix 1 Usual Operation Limits and Superheated Operating Limits

JIS C 1602-1995

Component symbol	Old symbol (reference)	Wire diameter mm	Usual operation limit °C	Superheated operating limit °C
B	—	0.50	1500	1700
R	—	0.50	1400	1600
S				
K	CA	0.65	650	850
		1.00	750	950
		1.60	850	1050
		2.30	900	1100
		3.20	1000	1200
E	CRC	0.65	450	500
		1.00	500	550
		1.60	550	600
		2.30	600	750
		3.20	700	800
J	IC	0.65	400	500
		1.00	450	550
		1.60	500	650
		2.30	550	750
		3.20	600	750
T	CC	0.32	200	250
		0.65	200	250
		1.00	250	300
		1.60	300	350

Note : The usual operation limit refers to the temperature limit of the air in which the module can be continuously used.
 The superheated operating limit refers to the limit of temperature at which the module can be used in a short period of time in unavoidable cases.

Appendix 2 Allowable Temperature Differences

JIS C 1602-1995

Component symbol	Old symbol (reference)	Measured temperature	Class	Allowable difference
B	—	600 °C or more but less than 1700 °C	0.5 class	±4 °C, or ±0.5 % of the measured temperature
R	—	0 °C or more but less than 1600 °C	0.25 class	±1.5 °C, or ±0.25 % of the measured temperature
S				
K	CA	0 °C or more but less than 1000 °C	0.4 class	±1.5 °C, or ±0.4 % of the measured temperature
		0 °C or more but less than 1200 °C	0.75 class	±2.5 °C, or ±0.75 % of the measured temperature
		-200 °C or more but less than 0 °C	1.5 class	±2.5 °C, or ±1.5 % of the measured temperature
E	CRC	0 °C or more but less than 800 °C	0.4 class	±1.5 °C, or ±0.4 % of the measured temperature
		0 °C or more but less than 800 °C	0.75 class	±2.5 °C, or ±0.75 % of the measured temperature
		-200 °C or more but less than 0 °C	1.5 class	±2.5 °C, or ±1.5 % of the measured temperature
J	IC	0 °C or more but less than 750 °C	0.4 class	±1.5 °C, or ±0.4 % of the measured temperature
		0 °C or more but less than 750 °C	0.75 class	±2.5 °C, or ±0.75 % of the measured temperature
		0 °C or more but less than 350 °C	0.4 class	±0.5 °C, or ±0.4 % of the measured temperature
T	CC	0 °C or more but less than 350 °C	0.75 class	±1 °C, or ±0.75 % of the measured temperature
		0 °C or more but less than 350 °C	0.4 class	±0.5 °C, or ±0.4 % of the measured temperature
		-200 °C or more but less than 0 °C	1.5 class	±1 °C, or ±1.5 % of the measured temperature

Note : The allowable difference refers to the maximum allowable limit for the difference between the resultant temperature of a conversion from thermal electromotive force using a standard thermal electromotive force chart, and the temperature at temperature detector contact.
 The greater value of °C or % will take effect for the allowable difference.



Appendix 3 Thermal Electromotive Force Chart

Type B

Appendix 3.1 Standard Thermal Electromotive Force of B

JIS C 1602-1995 (Conform to IEC 584-1(1977), IEC 584-2(1982))

Unit μV

Temperature (°C)	0	1	2	3	4	5	6	7	8	9	Temperature (°C)
0	0	0	0	-1	-1	-1	-1	-1	-2	-2	0
10	-2	-2	-2	-2	-2	-2	-2	-2	-3	-3	10
20	-3	-3	-3	-3	-3	-2	-2	-2	-2	-2	20
30	-2	-2	-2	-2	-2	-1	-1	-1	-1	-1	30
40	0	0	0	0	0	1	1	1	2	2	40
50	2	3	3	3	4	4	4	5	5	6	50
60	6	7	7	8	8	9	9	10	10	11	60
70	11	12	12	13	14	14	15	15	16	17	70
80	17	18	19	20	20	21	22	22	23	24	80
90	25	26	26	27	28	29	30	31	31	32	90
100	33	34	35	36	37	38	39	40	41	42	100
110	43	44	45	46	47	48	49	50	51	52	110
120	53	55	56	57	58	59	60	62	63	64	120
130	65	66	68	69	70	72	73	74	75	77	130
140	78	79	81	82	84	85	86	88	89	91	140
150	92	94	95	96	98	99	101	102	104	106	150
160	107	109	110	112	113	115	117	118	120	122	160
170	123	125	127	128	130	132	134	135	137	139	170
180	141	142	144	146	148	150	151	153	155	157	180
190	159	161	163	165	166	168	170	172	174	176	190
200	178	180	182	184	186	188	190	192	195	197	200
210	199	201	203	205	207	209	212	214	216	218	210
220	220	222	225	227	229	231	234	236	238	241	220
230	243	245	248	250	252	255	257	259	262	264	230
240	267	269	271	274	276	279	281	284	286	289	240
250	291	294	296	299	301	304	307	309	312	314	250
260	317	320	322	325	328	330	333	336	338	341	260
270	344	347	349	352	355	358	360	363	366	369	270
280	372	375	377	380	383	386	389	392	395	398	280
290	401	404	407	410	413	416	419	422	425	428	290
300	431	434	437	440	443	446	449	452	455	458	300
310	462	465	468	471	474	478	481	484	487	490	310
320	494	497	500	503	507	510	513	517	520	523	320
330	527	530	533	537	540	544	547	550	554	557	330
340	561	564	568	571	575	578	582	585	589	592	340
350	596	599	603	607	610	614	617	621	625	628	350
360	632	636	639	643	647	650	654	658	662	665	360
370	669	673	677	680	684	688	692	696	700	703	370
380	707	711	715	719	723	727	731	735	738	742	380
390	746	750	754	758	762	766	770	774	778	782	390
400	787	791	795	799	803	807	811	815	819	824	400
410	828	832	836	840	844	849	853	857	861	866	410
420	870	874	878	883	887	891	896	900	904	909	420
430	913	917	922	926	930	935	939	944	948	953	430
440	957	961	966	970	975	979	984	988	993	997	440
450	1002	1007	1011	1016	1020	1025	1030	1034	1039	1043	450
460	1048	1053	1057	1062	1067	1071	1076	1081	1086	1090	460
470	1095	1100	1105	1109	1114	1119	1124	1129	1133	1138	470
480	1143	1148	1153	1158	1163	1167	1172	1177	1182	1187	480
490	1192	1197	1202	1027	1212	1217	1222	1227	1232	1237	490

Type B

JIS C 1602-1995 (Conform to IEC 584-1(1977), IEC 584-2(1982))

Unit μV

Temperature (°C)	0	1	2	3	4	5	6	7	8	9	Temperature (°C)
500	1242	1247	1252	1257	1262	1267	1272	1277	1282	1288	500
510	1293	1298	1303	1308	1313	1318	1324	1329	1334	1339	510
520	1344	1350	1355	1360	1365	1371	1376	1381	1387	1392	520
530	1397	1402	1408	1413	1418	1424	1429	1435	1440	1445	530
540	1451	1456	1462	1467	1472	1478	1483	1489	1494	1500	540
550	1505	1511	1516	1522	1527	1533	1539	1544	1550	1555	550
560	1561	1566	1572	1578	1583	1589	1595	1600	1606	1612	560
570	1617	1623	1629	1634	1640	1646	1652	1657	1663	1669	570
580	1675	1680	1686	1692	1698	1704	1709	1715	1721	1727	580
590	1733	1739	1745	1750	1756	1762	1768	1774	1780	1786	590
600	1792	1798	1804	1810	1816	1822	1828	1834	1840	1846	600
610	1852	1858	1864	1870	1876	1882	1888	1894	1901	1907	610
620	1913	1919	1925	1931	1937	1944	1950	1956	1962	1968	620
630	1975	1981	1987	1993	1999	2006	2012	2018	2025	2031	630
640	2037	2043	2050	2056	2062	2069	2075	2082	2088	2094	640
650	2101	2107	2113	2120	2126	2133	2139	2146	2152	2158	650
660	2165	2171	2178	2184	2191	2197	2204	2210	2217	2224	660
670	2230	2237	2243	2250	2256	2263	2270	2276	2283	2289	670
680	2296	2303	2309	2316	2323	2329	2336	2343	2350	2356	680
690	2363	2370	2376	2383	2390	2397	2403	2410	2417	2424	690
700	2431	2437	2444	2451	2458	2456	2472	2479	2485	2492	700
710	2499	2506	2513	2520	2527	2534	2541	2548	2555	2562	710
720	2569	2576	2583	2590	2597	2604	2611	2618	2625	2632	720
730	2639	2646	2653	2660	2667	2674	2681	2688	2696	2703	730
740	2710	2717	2724	2731	2738	2746	2753	2760	2767	2775	740
750	2782	2789	2796	2803	2811	2818	2825	2833	2840	2847	750
760	2854	2862	2869	2876	2884	2891	2898	2906	2913	2921	760
770	2928	2935	2943	2950	2958	2965	2973	2980	2987	2995	770
780	3002	3010	3017	3025	3032	3040	3047	3055	3062	3070	780
790	3078	3085	3093	3100	3108	3116	3123	3131	3138	3146	790
800	3154	3161	3169	3177	3184	3192	3200	3207	3215	3223	800
810	3230	3238	3246	3254	3261	3269	3277	3285	3292	3300	810
820	3308	3316	3324	3331	3339	3347	3355	3363	3371	3379	820
830	3386	3394	3402	3410	3418	3426	3434	3442	3450	3458	830
840	3466	3474	3482	3490	3498	3506	3514	3522	3530	3538	840
850	3546	3554	3562	3570	3578	3586	3594	3602	3610	3618	850
860	3626	3634	3643	3651	3659	3667	3675	3683	3692	3700	860
870	3708	3716	3724	3732	3741	3749	3757	3765	3774	3782	870
880	3790	3798	3807	3815	3823	3832	3840	3848	3857	3865	880
890	3873	3882	3890	3898	3907	3915	3923	3932	3940	3949	890
900	3957	3965	3974	3982	3991	3999	4008	4016	4024	4033	900
910	4041	4050	4058	4067	4075	4084	4093	4101	4110	4118	910
920	4127	4135	4144	4152	4161	4170	4178	4187	4195	4204	920
930	4213	4221	4230	4239	4247	4256	4265	4273	4282	4291	930
940	4299	4308	4317	4326	4334	4343	4352	4360	4369	4378	940
950	4387	4396	4404	4413	4422	4431	4440	4448	4457	4466	950
960	4475	4484	4493	4501	4510	4519	4528	4537	4546	4555	960
970	4564	4573	4582	4591	4599	4608	4617	4626	4635	4644	970
980	4653	4662	4671	4680	4689	4698	4707	4716	4725	4734	980
990	4743	4753	4762	4771	4780	4789	4798	4807	4816	4825	990

Type B

JIS C 1602-1995 (Conform to IEC 584-1(1977), IEC 584-2(1982))

Unit μV

Temperature (°C)	0	1	2	3	4	5	6	7	8	9	Temperature (°C)
1000	4834	4843	4853	4862	4871	4880	4889	4898	4908	4917	1000
1010	4926	4935	4944	4954	4963	4972	4981	4990	5000	5009	1010
1020	5018	5027	5037	5046	5055	5065	5074	5083	5092	5102	1020
1030	5111	5120	5130	5139	5148	5158	5167	5176	5186	5195	1030
1040	5205	5214	5223	5233	5242	5252	5261	5270	5280	5289	1040
1050	5299	5308	5318	5327	5337	5346	5356	5365	5375	5384	1050
1060	5394	5403	5413	5422	5432	5441	5451	5460	5470	5480	1060
1070	5489	5499	5508	5518	5528	5537	5547	5556	5566	5576	1070
1080	5585	5595	5605	5614	5624	5634	5643	5653	5663	5672	1080
1090	5682	5692	5702	5711	5721	5731	5740	5750	5760	5770	1090
1100	5780	5789	5799	5809	5819	5828	5838	5848	5858	5868	1100
1110	5878	5887	5897	5907	5917	5927	5937	5947	5956	5966	1110
1120	5976	5986	5996	6006	6016	6026	6036	6046	6055	6065	1120
1130	6075	6085	6095	6105	6115	6125	6135	6145	6155	6165	1130
1140	6175	6185	6195	6205	6215	6225	6235	6245	6256	6266	1140
1150	6276	6286	6296	6306	6316	6326	6336	6346	6356	6367	1150
1160	6377	6387	6397	6407	6417	6427	6438	6448	6458	6468	1160
1170	6478	6488	6499	6509	6519	6529	6539	6550	6560	6570	1170
1180	6580	9591	6601	6611	6621	6632	6642	6652	6663	6673	1180
1190	6683	6693	6704	6714	6724	6735	6745	6755	6766	6776	1190
1200	6786	6797	6807	6818	6828	6838	6849	6859	6869	6880	1200
1210	6890	6904	6911	6922	6932	6942	6953	6963	6974	6984	1210
1220	6995	7005	7016	7026	7037	7047	7058	7068	7079	7089	1220
1230	7100	7110	7121	7131	7142	7152	7163	7173	7184	7194	1230
1240	7205	7216	7226	7237	7247	7258	7269	7279	7290	7300	1240
1250	7311	7322	7332	7343	7353	7364	7375	7385	7396	7407	1250
1260	7417	7428	7439	7449	7460	7471	7482	7492	7503	7514	1260
1270	7524	7535	7546	7557	7567	7578	7589	7600	7610	7621	1270
1280	7632	7643	7653	7664	7675	7686	7697	7707	7718	7729	1280
1290	7740	7754	7761	7772	7783	7794	7805	7816	7827	7837	1290
1300	7848	7859	7870	7881	7892	7903	7914	7924	7935	7946	1300
1310	7957	7968	7979	7990	8001	8012	8023	8034	8045	8058	1310
1320	8066	8077	8088	8099	8110	8121	8132	8143	8154	8165	1320
1330	8176	8187	8198	8209	8220	8231	8242	8253	8264	8275	1330
1340	8286	8298	8309	8320	8331	8342	8353	8364	8375	8386	1340
1350	8397	8408	8419	8430	8441	8453	8464	8475	8486	8497	1350
1360	8508	8519	8530	8542	8553	8564	8575	8586	8597	8608	1360
1370	8620	8631	8642	8653	8664	8675	8687	8698	8709	8720	1370
1380	8731	8743	8754	8765	8776	8787	8799	8810	8821	8832	1380
1390	8844	8855	8866	8877	8889	8900	8911	8922	8934	8945	1390
1400	8956	8967	8979	8990	9001	9013	9024	9035	9047	9058	1400
1410	9069	9080	9092	9103	9114	9126	9137	9148	9160	9171	1410
1420	9182	9194	9205	9216	9228	9239	9251	9262	9273	9285	1420
1430	9296	9307	9319	9330	9342	9353	9364	9376	9387	9398	1430
1440	9410	9421	9433	9444	9456	9467	9478	9490	9501	9513	1440
1450	9524	9536	9547	9558	9570	9581	9593	9604	9616	9627	1450
1460	9639	9650	9662	9673	9684	9696	9707	9719	9730	9742	1460
1470	9753	9765	9776	9788	9799	9811	9822	9834	9845	9857	1470
1480	9868	9880	9891	9903	9914	9926	9937	9949	9961	9972	1480
1490	9984	9995	10007	10018	10030	10041	10053	10064	10076	10088	1490

Type B

JIS C 1602-1995 (Conform to IEC 584-1(1977), IEC 584-2(1982))

Unit μV

Temperature (°C)	0	1	2	3	4	5	6	7	8	9	Temperature (°C)
1500	10099	10111	10122	10134	10145	10157	10168	10180	10192	10203	1500
1510	10215	10226	10238	10249	10261	10273	10284	10296	10307	10319	1510
1520	10331	10342	10354	10365	10377	10389	10400	10412	10423	10435	1520
1530	10447	10458	10470	10482	10493	10505	10516	10528	10540	10551	1530
1540	10563	10575	10586	10598	10609	10621	10633	10644	10656	10668	1540
1550	10679	10691	10703	10714	10726	10738	10749	10761	10773	10784	1550
1560	10796	10808	10819	10831	10843	10854	10866	10877	10889	10901	1560
1570	10913	10924	10936	10948	10959	10971	10983	10994	11006	11018	1570
1580	11029	11041	11053	11064	11076	11088	11099	11111	11123	11134	1580
1590	11146	11158	11169	11181	11193	11205	11216	11228	11240	11251	1590
1600	11263	11275	11286	11298	11310	11321	11333	11345	11357	11368	1600
1610	11380	11392	11403	11415	11427	11438	11450	11462	11474	11485	1610
1620	11497	11509	11520	11532	11544	11555	11567	11579	11591	11602	1620
1630	11614	11626	11637	11649	11661	11673	11684	11696	11708	11719	1630
1640	11731	11743	11754	11766	11778	11790	11804	11813	11825	11836	1640
1650	11848	11860	11871	11883	11895	11907	11918	11930	11942	11953	1650
1660	11965	11977	11988	12000	12012	12024	12035	12047	12059	12070	1660
1670	12082	12094	12105	12117	12129	12141	12152	12164	12176	12187	1670
1680	12199	12211	12222	12234	12246	12257	12269	12281	12292	12304	1680
1690	12316	12327	12339	12351	12363	12374	12386	12398	12409	12421	1690
1700	12433	12444	12456	12468	12479	12491	12503	12514	12526	12538	1700
1710	12549	12561	12572	12584	12596	12607	12619	12631	12642	12654	1710
1720	12666	12677	12689	12701	12712	12724	12736	12747	12759	12770	1720
1730	12782	12794	12805	12817	12829	12840	12852	12863	12875	12887	1730
1740	12898	12910	12921	12933	12945	12956	12968	12980	12991	13003	1740
1750	13014	13026	13037	13049	13061	13072	13084	13095	13107	13119	1750
1760	13130	13142	13153	13165	13176	13188	13200	13211	13223	13234	1760
1770	13246	13257	13269	13280	13292	13304	13315	13327	13338	13350	1770
1780	13361	13373	13384	13396	13407	13419	13430	13442	13453	13465	1780
1790	13476	13488	13499	13511	13522	13534	13545	13557	13568	13580	1790
1800	13591	13603	13614	13626	13637	13649	13660	13672	13683	13694	1800
1810	13706	13717	13729	13740	13752	13763	13775	13786	13797	13809	1810
1820	13820										1820

REMARK

Standard contact temperature is 0 °C.

Appendix 3.2 Standard Thermal Electromotive Force of R

Type R
Unit μV

JIS C 1602-1995 (Conform to IEC 584-1(1977), IEC 584-2(1982))

Temperature (°C)	0	-1	-2	-3	-4	-5	-6	-7	-8	-9	Temperature (°C)
-50	-226										-50
-40	-188	-192	-196	-200	-204	-208	-211	-215	-219	-223	-40
-30	-145	-150	-154	-158	-163	-167	-171	-175	-180	-184	-30
-20	-100	-105	-109	-114	-119	-123	-128	-132	-137	-141	-20
-10	-51	-56	-61	-66	-71	-76	-81	-86	-91	-95	-10
0	0	-5	-11	-16	-21	-26	-31	-36	-41	-46	0
Temperature (°C)	0	1	2	3	4	5	6	7	8	9	Temperature (°C)
0	0	5	11	16	21	27	32	38	43	49	0
10	54	60	65	71	77	82	88	94	100	105	10
20	111	117	123	129	135	141	147	153	159	165	20
30	171	177	183	189	195	201	207	214	220	226	30
40	232	239	245	251	258	264	271	277	284	290	40
50	296	303	310	316	323	329	336	343	349	356	50
60	363	369	376	383	390	397	403	410	417	424	60
70	431	438	445	452	459	466	473	480	487	494	70
80	501	508	516	523	530	537	544	552	559	566	80
90	573	581	588	595	603	610	618	625	632	640	90
100	647	655	662	670	677	685	693	700	708	715	100
110	723	731	738	746	754	761	769	777	785	792	110
120	800	808	816	824	832	839	847	855	863	871	120
130	879	887	895	903	911	919	927	935	943	951	130
140	959	967	976	984	992	1000	1008	1016	1025	1033	140
150	1041	1049	1058	1066	1074	1082	1091	1099	1107	1116	150
160	1124	1132	1141	1149	1158	1166	1175	1183	1191	1200	160
170	1208	1217	1225	1234	1242	1251	1260	1268	1277	1285	170
180	1294	1303	1311	1320	1329	1337	1346	1355	1363	1372	180
190	1381	1389	1398	1407	1416	1425	1433	1442	1451	1460	190
200	1469	1477	1486	1495	1504	1513	1522	1531	1540	1549	200
210	1558	1567	1575	1584	1593	1602	1611	1620	1629	1639	210
220	1648	1657	1666	1675	1684	1693	1702	1711	1720	1729	220
230	1739	1748	1757	1766	1775	1784	1794	1803	1812	1821	230
240	1831	1840	1849	1858	1868	1877	1886	1895	1905	1914	240
250	1923	1933	1942	1951	1961	1970	1980	1989	1998	2008	250
260	2017	2027	2036	2046	2055	2064	2074	2083	2093	2102	260
270	2112	2121	2131	2140	2150	2159	2169	2179	2188	2198	270
280	2207	2217	2226	2236	2246	2255	2265	2275	2284	2294	280
290	2304	2313	2323	2333	2342	2352	2362	2371	2381	2391	290
300	2401	2410	2420	2430	2440	2449	2459	2469	2479	2488	300
310	2498	2508	2518	2528	2538	2547	2557	2567	2577	2587	310
320	2597	2607	2617	2626	2636	2646	2656	2666	2676	2686	320
330	2696	2706	2716	2726	2736	2746	2756	2766	2776	2786	330
340	2796	2806	2816	2826	2836	2846	2856	2866	2876	2886	340
350	2896	2906	2916	2926	2937	2947	2957	2967	2977	2987	350
360	2997	3007	3018	3028	3038	3048	3058	3068	3079	3089	360
370	3099	3109	3119	3130	3140	3150	3160	3171	3181	3191	370
380	3201	3212	3222	3232	3242	3253	3263	3273	3284	3294	380
390	3304	3315	3325	3335	3346	3356	3366	3377	3387	3397	390

Type R

JIS C 1602-1995 (Conform to IEC 584-1(1977), IEC 584-2(1982))

Unit μV

Temperature (°C)	0	1	2	3	4	5	6	7	8	9	Temperature (°C)
400	3408	3418	3428	3439	3449	3460	3470	3480	3491	3501	400
410	3512	3522	3533	3543	3553	3564	3574	3585	3595	3606	410
420	3616	3627	3637	3648	3658	3669	3679	3690	3700	3711	420
430	3721	3732	3742	3753	3764	3774	3785	3795	3806	3816	430
440	3827	3838	3848	3859	3869	3880	3891	3901	3912	3922	440
450	3933	3944	3954	3965	3976	3986	3997	4008	4018	4029	450
460	4040	4050	4061	4072	4083	4093	4104	4115	4125	4136	460
470	4147	4158	4168	4179	4190	4201	4211	4222	4233	4244	470
480	4255	4265	4276	4287	4298	4309	4319	4330	4341	4352	480
490	4363	4373	4384	4395	4406	4417	4428	4439	4449	4460	490
500	4471	4482	4493	4504	4515	4526	4537	4548	4558	4569	500
510	4580	4591	4602	4613	4624	4635	4646	4657	4668	4679	510
520	4690	4701	4712	4723	4734	4745	4756	4767	4778	4789	520
530	4800	4811	4822	4833	4844	4855	4866	4877	4888	4899	530
540	4910	4922	4933	4944	4955	4966	4977	4988	4999	5010	540
550	5021	5033	5044	5055	5066	5077	5088	5099	5111	5122	550
560	5133	5144	5155	5166	5178	5189	5200	5211	5222	5234	560
570	5245	5256	5267	5279	5290	5301	5312	5323	5335	5346	570
580	5357	5369	5380	5391	5402	5414	5425	5436	5448	5459	580
590	5470	5481	5493	5504	5515	5527	5538	5549	5561	5572	590
600	5583	5595	5606	5618	5629	5640	5652	5663	5674	5686	600
610	5697	5709	5720	5731	5743	5754	5766	5777	5789	5800	610
620	5812	5823	5834	5846	5857	5869	5880	5892	5903	5915	620
630	5926	5938	5949	5961	5972	5984	5995	6007	6018	6030	630
640	6041	6053	6065	6076	6088	6099	6111	6122	6131	6146	640
650	6157	6169	6180	6192	6204	6215	6227	6238	6250	6262	650
660	6273	6285	6297	6308	6320	6332	6343	6355	6367	6378	660
670	6390	6402	6413	6425	6437	6448	6460	6472	6484	6495	670
680	6507	6519	6531	6542	6554	6566	6578	6589	6601	6613	680
690	6625	6636	6648	6660	6672	6684	6695	6707	6719	6731	690
700	6743	6755	6766	6778	6790	6802	6814	6826	6838	6849	700
710	6861	6873	6885	6897	6909	6921	6933	6945	6956	6968	710
720	6980	6992	7004	7016	7028	7040	7052	7064	7076	7088	720
730	7100	7112	7124	7136	7148	7160	7172	7184	7296	7208	730
740	7220	7232	7244	7256	7268	7280	7292	7304	7316	7328	740
750	7340	7352	7364	7376	7389	7401	7413	7425	7437	7449	750
760	7461	7473	7485	7498	7510	7522	7534	7546	7558	7570	760
770	7583	7595	7607	7619	7631	7644	7656	7668	7680	7692	770
780	7705	7717	7729	7741	7753	7766	7778	7790	7802	7815	780
790	7827	7839	7854	7861	7876	7888	7901	7913	7925	7938	790
800	7950	7962	7974	7987	7999	8011	8024	8036	8048	8061	800
810	8073	8086	8098	8110	8123	8135	8147	8160	8172	8185	810
820	8197	8209	8222	8234	8247	8259	8272	8284	8296	8309	820
830	8321	8334	8346	8359	8371	8384	8396	8409	8421	8434	830
840	8446	8459	8471	8484	8496	8509	8521	8534	8546	8559	840
850	8571	8584	8597	8609	8622	8634	8647	8659	8672	8685	850
860	8697	8710	8722	8735	8748	8760	8773	8785	8798	8811	860
870	8823	8836	8849	8861	8874	8887	8899	8912	8925	8937	870
880	8950	8963	8975	8988	9001	9014	9026	9039	9052	9065	880
890	9077	9090	9103	9115	9128	9141	9154	9167	9179	9192	890

Type R

JIS C 1602-1995 (Conform to IEC 584-1(1977), IEC 584-2(1982))

Unit μV

Temperature (°C)	0	1	2	3	4	5	6	7	8	9	Temperature (°C)
900	9205	9218	9230	9243	9256	9269	9282	9294	9307	9320	900
910	9333	9346	9359	9371	9384	9397	9410	9423	9436	9449	910
920	9461	9474	9487	9500	9513	9526	9539	9552	9565	9578	920
930	9590	9603	9616	9629	9642	9655	9668	9681	9694	9707	930
940	9720	9733	9746	9759	9772	9785	9798	9811	9824	9837	940
950	9850	9863	9876	9889	9902	9915	9928	9941	9954	9967	950
960	9980	9993	10006	10019	10032	10046	10059	10072	10085	10098	960
970	10111	10124	10137	10150	10163	10177	10190	10203	10216	10229	970
980	10242	10255	10268	10282	10295	10308	10321	10334	10347	10361	980
990	10374	10387	10400	10413	10427	10440	10453	10466	10480	10493	990
1000	10506	10519	10532	10546	10559	10572	10585	10599	10612	10625	1000
1010	10638	10652	10665	10678	10692	10705	10718	10731	10745	10758	1010
1020	10771	10785	10798	10811	10825	10838	10851	10865	10878	10891	1020
1030	10905	10918	10932	10945	10958	10972	10985	10998	11012	11025	1030
1040	11039	11052	11065	11079	11092	11106	11119	11132	11146	11159	1040
1050	11173	11186	11200	11213	11227	11240	11253	11267	11280	11294	1050
1060	11307	11321	11334	11348	11361	11375	11388	11402	11415	11429	1060
1070	11442	11456	11469	11483	11496	11510	11524	11537	11551	11564	1070
1080	11578	11591	11605	11618	11632	11646	11659	11673	11686	11700	1080
1090	11714	11727	11741	11754	11768	11782	11795	11809	11822	11836	1090
1100	11850	11863	11877	11891	11904	11918	11931	11945	11959	11972	1100
1110	11986	12000	12013	12027	12041	12054	12068	12082	12096	12109	1110
1120	12123	12137	12150	12164	12178	12191	12205	12219	12233	12246	1120
1130	12260	12274	12288	12301	12315	12329	12342	12356	12370	12384	1130
1140	12397	12411	12425	12439	12453	12466	12480	12494	12508	12521	1140
1150	12535	12549	12563	12577	12590	12604	12618	12632	12646	12659	1150
1160	12673	12687	12701	12715	12729	12742	12756	12770	12784	12798	1160
1170	12812	12825	12839	12853	12867	12881	12895	12909	12922	12936	1170
1180	12950	12961	12978	12992	13006	13019	13033	13047	13061	13075	1180
1190	13089	13103	13117	13131	13145	13158	13172	13186	13200	13214	1190
1200	13228	13242	13256	13270	13281	13298	13311	13325	13339	13353	1200
1210	13367	13381	13395	13400	13123	13437	13451	13465	13479	13493	1210
1220	13507	13521	13535	13549	13563	13577	13590	13604	13618	13632	1220
1230	13646	13660	13674	13688	13702	13716	13730	13744	13758	13772	1230
1240	13786	13800	13814	13828	13812	13856	13870	13884	13898	13912	1240
1250	13926	13940	13954	13968	13982	13996	14010	14024	14038	14052	1250
1260	14066	14081	14095	14109	14123	14137	14151	14165	14179	14193	1260
1270	14207	14221	14235	14249	14263	14277	14291	14305	14319	14333	1270
1280	14347	14361	14375	14390	14404	14418	14432	14446	14460	14474	1280
1290	14488	14502	14516	14530	14544	14558	14572	14586	14601	14615	1290
1300	14629	14643	14657	14671	14685	14699	14713	14727	14741	14755	1300
1310	14770	14784	14798	14812	14826	14840	14854	14868	14882	14896	1310
1320	14911	14925	14939	14953	14967	14981	14995	15009	15023	15037	1320
1330	15052	15066	15080	15094	15108	15122	15136	15150	15164	15179	1330
1340	15193	15207	15221	15235	15249	15263	15277	15291	15306	15320	1340
1350	15334	15348	15362	15376	15390	15401	15419	15433	15447	15461	1350
1360	15475	15489	15503	15517	15531	15546	15560	15574	15588	15602	1360
1370	15616	15630	15645	15659	15673	15687	15701	15715	15729	15743	1370
1380	15758	15772	15786	15800	15814	15828	15842	15856	15871	15885	1380
1390	15899	15913	15927	15941	15955	15969	15984	15998	16012	16026	1390

Type R

JIS C 1602-1995 (Conform to IEC 584-1(1977), IEC 584-2(1982))

Unit μV

Temperature (°C)	0	1	2	3	4	5	6	7	8	9	Temperature (°C)
1400	16040	16054	16068	16082	16097	16111	16125	16139	16153	16167	1400
1410	16181	16196	16210	16224	16238	16252	16266	16280	16294	16309	1410
1420	16323	16337	16351	16365	16379	16393	16407	16422	16436	16450	1420
1430	16464	16478	16492	16506	16520	16534	16549	16563	16577	16591	1430
1440	16605	16619	16633	16647	16662	16676	16690	16704	16718	16732	1440
1450	16746	16760	16774	16789	16803	16817	16831	16845	16859	16873	1450
1460	16887	16901	16915	16930	16944	16958	16972	16986	17000	17014	1460
1470	17028	17042	17056	17071	17085	17099	17113	17127	12141	17155	1470
1480	17169	17183	17197	17211	17225	17240	17254	17268	17282	17296	1480
1490	17310	17324	17338	17352	17366	17380	17394	17408	17423	17437	1490
1500	17451	17465	17479	17493	17507	17521	17535	17549	17563	17577	1500
1510	17591	17605	17619	17633	17647	17661	17676	17690	17704	17718	1510
1520	17732	17746	17760	17774	17788	17802	17816	17830	17844	17858	1520
1530	17872	17886	17900	17914	17928	17942	17956	17970	17984	17998	1530
1540	18012	18026	18040	18054	18068	18082	18096	18110	18124	18138	1540
1550	18152	18166	18180	18194	18208	18222	18236	18250	18264	18278	1550
1560	18292	18306	18320	18334	18348	18362	18376	18390	18404	18417	1560
1570	18431	18445	18459	18473	18487	18501	18515	18529	18543	18557	1570
1580	18571	18585	18599	18613	18627	18640	18654	18668	18682	18696	1580
1590	18710	18724	18738	18752	18766	18779	18793	18807	18821	18835	1590
1600	18849	18863	18877	18891	18904	18918	18932	18946	18960	18974	1600
1610	18988	19002	19015	19029	19043	19057	19071	19085	19098	19112	1610
1620	19126	19140	19154	19168	19181	19195	19209	19223	19237	19250	1620
1630	19264	19278	19292	19306	19319	19333	19347	19361	19375	19388	1630
1640	19402	19416	19430	19444	19457	19471	19485	19499	19512	19526	1640
1650	19540	19554	19567	19581	19595	19609	19622	19636	19650	19663	1650
1660	19677	19691	19705	19718	19732	19746	19759	19773	19787	19800	1660
1670	19814	19828	19841	19855	19869	19882	19896	19910	19923	19937	1670
1680	19951	19964	19978	19992	20005	20019	20032	20046	20060	20073	1680
1690	20087	20100	20114	20127	20141	20154	20168	20181	20195	20208	1690
1700	20222	20235	20249	20262	20275	20289	20302	20316	20329	20342	1700
1710	20356	20369	20382	20396	20409	20422	20436	20449	20462	20475	1710
1720	20488	20502	20515	20528	20541	20554	20567	20580	20593	20607	1720
1730	20620	20633	20646	20659	20672	20685	20698	20711	20724	20736	1730
1740	20749	20762	20775	20788	20801	20813	20826	20839	20852	20864	1740
1750	20877	20890	20902	20915	20928	20940	20953	20965	20978	20990	1750
1760	21003	21015	21027	21040	21052	21065	21077	21089	21101	21113	1760

REMARK

Standard contact temperature is 0 °C.

Appendix 3.3 Standard Thermal Electromotive Force of S

Type S
Unit μV

JIS C 1602-1995 (Conform to IEC 584-1(1977), IEC 584-2(1982))

Temperature (°C)	0	-1	-2	-3	-4	-5	-6	-7	-8	-9	Temperature (°C)
-50	-236										-50
-40	-194	-199	-203	-207	-211	-215	-219	-224	-228	-232	-40
-30	-150	-155	-159	-164	-168	-173	-177	-181	-186	-190	-30
-20	-103	-108	-113	-117	-122	-127	-132	-136	-141	-146	-20
-10	-53	-58	-63	-68	-73	-78	-83	-88	-93	-98	-10
0	0	-5	-11	-16	-21	-27	-32	-37	-42	-48	0
Temperature (°C)	0	1	2	3	4	5	6	7	8	9	Temperature (°C)
0	0	5	11	16	22	27	33	38	44	50	0
10	55	61	67	72	78	84	90	95	101	107	10
20	113	119	125	131	137	143	149	155	161	167	20
30	173	179	185	191	197	204	210	216	222	229	30
40	235	241	248	254	260	267	273	280	286	292	40
50	299	305	312	319	325	332	338	345	352	358	50
60	365	372	378	385	392	399	405	412	419	426	60
70	433	440	446	453	460	467	474	481	488	495	70
80	502	509	516	523	530	538	545	552	559	566	80
90	573	580	588	595	602	609	617	624	631	639	90
100	646	653	661	668	675	683	690	698	705	713	100
110	720	727	735	743	750	758	765	773	780	788	110
120	795	803	811	818	826	834	841	849	857	865	120
130	872	880	888	896	903	911	919	927	935	942	130
140	950	958	966	974	982	990	998	1006	1013	1021	140
150	1029	1037	1045	1053	1061	1069	1077	1085	1094	1102	150
160	1110	1118	1126	1134	1142	1150	1158	1167	1175	1183	160
170	1191	1199	1207	1216	1224	1232	1240	1249	1257	1265	170
180	1273	1282	1290	1298	1307	1315	1323	1332	1340	1348	180
190	1357	1365	1373	1382	1390	1399	1407	1415	1424	1432	190
200	1441	1449	1458	1466	1475	1483	1492	1500	1509	1517	200
210	1526	1534	1543	1551	1560	1569	1577	1586	1594	1603	210
220	1612	1620	1629	1638	1646	1655	1663	1672	1681	1690	220
230	1698	1707	1716	1724	1733	1742	1751	1759	1768	1777	230
240	1786	1794	1803	1812	1821	1829	1838	1847	1856	1865	240
250	1874	1882	1891	1900	1909	1918	1927	1936	1944	1953	250
260	1962	1971	1980	1989	1998	2007	2016	2025	2034	2043	260
270	2052	2061	2070	2078	2087	2096	2105	2114	2123	2132	270
280	2141	2151	2160	2169	2178	2187	2196	2205	2214	2223	280
290	2232	2241	2250	2259	2268	2277	2287	2296	2305	2314	290
300	2323	2332	2341	2350	2360	2369	2378	2387	2396	2405	300
310	2415	2424	2433	2442	2451	2461	2470	2479	2488	2497	310
320	2507	2516	2525	2534	2544	2553	2562	2571	2581	2590	320
330	2599	2609	2618	2627	2636	2646	2655	2664	2674	2683	330
340	2692	2702	2711	2720	2730	2739	2748	2758	2767	2776	340
350	2786	2795	2805	2814	2823	2833	2842	2851	2861	2870	350
360	2880	2889	2899	2908	2917	2927	2936	2946	2955	2965	360
370	2974	2983	2993	3002	3012	3021	3031	3040	3050	3059	370
380	3069	3078	3088	3097	3107	3116	3126	3135	3145	3154	380
390	3164	3173	3183	3192	3202	3212	3221	3231	3240	3250	390

Type S

JIS C 1602-1995 (Conform to IEC 584-1(1977), IEC 584-2(1982))

Unit μV

Temperature (°C)	0	1	2	3	4	5	6	7	8	9	Temperature (°C)
400	3259	3269	3279	3288	3298	3307	3317	3326	3336	3346	400
410	3355	3365	3374	3384	3394	3403	3413	3423	3432	3442	410
420	3451	3461	3471	3480	3490	3500	3509	3519	3529	3538	420
430	3548	3558	3567	3577	3587	3596	3606	3616	3626	3635	430
440	3645	3655	3664	3674	3684	3694	3703	3713	3723	3732	440
450	3742	3752	3762	3771	3781	3791	3801	3810	3820	3830	450
460	3840	3850	3859	3869	3879	3889	3898	3908	3918	3928	460
470	3938	3917	3957	3967	3977	3987	3997	4006	4016	4026	470
480	4036	4046	4056	4065	4075	4085	4095	4105	4115	4125	480
490	4134	4144	4154	4164	4174	4184	4194	4204	4213	4223	490
500	4233	4243	4253	4263	4273	4283	4293	4303	4313	4323	500
510	4332	4342	4352	4362	4372	4382	4392	4402	4412	4422	510
520	4432	4442	4452	4462	4472	4482	4492	4502	4512	4522	520
530	4532	4542	4552	4562	4572	4582	4592	4602	4612	4622	530
540	4632	4642	4652	4662	4672	4682	4692	4702	4712	4722	540
550	4732	4742	4752	4762	4772	4782	4793	4803	4813	4823	550
560	4833	4843	4853	4863	4873	4883	4893	4904	4914	4924	560
570	4934	4944	4954	4964	4974	4984	4995	5005	5015	5025	570
580	5035	5045	5055	5066	5076	5086	5096	5106	5116	5127	580
590	5137	5147	5157	5167	5178	5188	5198	5208	5218	5228	590
600	5239	5249	5259	5269	5280	5290	5300	5310	5320	5331	600
610	5341	5351	5361	5372	5382	5392	5402	5413	5423	5433	610
620	5443	5454	5464	5474	5485	5495	5505	5515	5526	5536	620
630	5546	5557	5567	5577	5588	5598	5608	5618	5629	5639	630
640	5619	5660	5670	5680	5691	5701	5712	5722	5732	5743	640
650	5753	5763	5774	5784	5791	5805	5815	5826	5836	5846	650
660	5857	5867	5878	5888	5898	5909	5919	5930	5940	5950	660
670	5961	5971	5982	5992	6003	6013	6024	6034	6044	6055	670
680	6065	6076	6086	6097	6107	6118	6128	6139	6149	6160	680
690	6170	6181	6191	6202	6212	6223	6233	6244	6254	6265	690
700	6275	6286	6296	6307	6317	6328	6338	6349	6360	6370	700
710	6381	6391	6402	6412	6423	6434	6444	6455	6465	6476	710
720	6486	6497	6508	6518	6529	6539	6550	6561	6571	6582	720
730	6593	6603	6614	6624	6635	6646	6656	6667	6678	6688	730
740	6699	6710	6720	6731	6742	6752	6763	6774	6784	6795	740
750	6806	6817	6827	6838	6849	6859	6870	6881	6892	6902	750
760	6913	6924	6934	6945	6956	6967	6977	6988	6999	7010	760
770	7020	7031	7042	7053	7064	7074	7085	7096	7107	7117	770
780	7128	7139	7150	7161	7172	7182	7193	7204	7215	7226	780
790	7236	7247	7258	7269	7280	7291	7302	7312	7323	7334	790
800	7345	7356	7367	7378	7388	7399	7410	7421	7432	7443	800
810	7454	7465	7476	7487	7497	7508	7519	7530	7541	7552	810
820	7563	7574	7585	7596	7607	7618	7629	7640	7651	7662	820
830	7673	7684	7695	7706	7717	7728	7739	7750	7761	7772	830
840	7783	7794	7805	7816	7827	7838	7849	7860	7871	7882	840
850	7893	7904	7915	7926	7937	7948	7959	7970	7981	7992	850
860	8003	8014	8026	8037	8048	8059	8070	8081	8092	8103	860
870	8114	8125	8137	8148	8159	8170	8181	8192	8203	8214	870
880	8226	8237	8248	8259	8270	8281	8293	8304	8315	8326	880
890	8337	8348	8360	8371	8382	8393	8404	8416	8427	8438	890

Type S

JIS C 1602-1995 (Conform to IEC 584-1(1977), IEC 584-2(1982))

Unit μV

Temperature (°C)	0	1	2	3	4	5	6	7	8	9	Temperature (°C)
900	8449	8460	8472	8483	8494	8505	8517	8528	8539	8550	900
910	8562	8573	8584	8595	8607	8618	8629	8640	8652	8663	910
920	8674	8685	8697	8708	8719	8731	8742	8753	8765	8776	920
930	8787	8798	8810	8821	8832	8844	8855	8866	8878	8889	930
940	8900	8912	8923	8935	8946	8957	8969	8980	8991	9003	940
950	9014	9025	9037	9048	9060	9071	9082	9094	9105	9117	950
960	9128	9139	9151	9162	9174	9185	9197	9208	9219	9231	960
970	9242	9254	9265	9277	9288	9300	9311	9323	9334	9345	970
980	9357	9368	9380	9391	9403	9414	9426	9437	9449	9460	980
990	9472	9483	9495	9506	9518	9529	9541	9552	9564	9576	990
1000	9587	9599	9610	9622	9633	9645	9656	9668	9680	9691	1000
1010	9703	9714	9726	9737	9749	9761	9772	9784	9795	9807	1010
1020	9819	9830	9842	9853	9865	9877	9888	9900	9911	9923	1020
1030	9935	9916	9958	9970	9981	9993	10005	10016	10028	10040	1030
1040	10051	10063	10075	10086	10098	10110	10121	10133	10145	10156	1040
1050	10168	10180	10191	10203	10215	10227	10238	10250	10262	10273	1050
1060	10285	10297	10309	10320	10332	10344	10356	10367	10379	10391	1060
1070	10403	10414	10426	10438	10450	10461	10473	10485	10497	10509	1070
1080	10520	10532	10544	10556	10567	10579	10591	10603	10615	10626	1080
1090	10638	10650	10662	10674	10686	10697	10709	10721	10733	10745	1090
1100	10757	10768	10780	10792	10804	10816	10828	10839	10851	10863	1100
1110	10875	10887	10899	10911	10922	10934	10946	10958	10970	10982	1110
1120	10991	11006	11017	11029	11041	11053	11065	11077	11089	11101	1120
1130	11113	11125	11136	11148	11160	11172	11184	11196	11208	11220	1130
1140	11232	11244	11256	11268	11280	11291	11303	11315	11327	11339	1140
1150	11351	11363	11375	11387	11399	11411	11423	11435	11447	11459	1150
1160	11471	11483	11495	11507	11519	11531	11542	11554	11566	11578	1160
1170	11590	11602	11614	11626	11638	11650	11662	11674	11686	11698	1170
1180	11710	11722	11734	11746	11758	11770	11782	11794	11806	11818	1180
1190	11830	11842	11854	11866	11878	11890	11902	11914	11926	11939	1190
1200	11951	11963	11975	11987	11999	12011	12023	12035	12047	12059	1200
1210	12071	12083	12095	12107	12119	12131	12143	12155	12167	12179	1210
1220	12191	12203	12216	12228	12240	12252	12264	12276	12288	12300	1220
1230	12312	12324	12336	12348	12360	12372	12384	12397	12409	12421	1230
1240	12433	12445	12457	12469	12481	12493	12505	12517	12529	12542	1240
1250	12554	12566	12578	12590	12602	12614	12626	12638	12650	12662	1250
1260	12675	12687	12699	12711	12723	12735	12747	12759	12771	12783	1260
1270	12796	12808	12820	12832	12844	12856	12868	12880	12892	12905	1270
1280	12917	12929	12941	12953	12965	12977	12989	13001	13014	13026	1280
1290	13038	13050	13062	13074	13086	13098	13111	13123	13135	13147	1290
1300	13159	13171	13183	13195	13208	13220	13232	13244	13256	13268	1300
1310	13280	13292	23305	13317	13329	13341	13353	13365	13377	13390	1310
1320	13402	13414	13426	13438	13450	13462	13474	13487	13499	13511	1320
1330	13523	13535	13547	13559	13572	13584	13596	13608	13620	13632	1330
1340	13644	13657	13669	13681	13693	13705	13717	13729	13742	13754	1340
1350	13766	13778	13790	13802	13814	13826	13839	13851	13863	13875	1350
1360	13887	13899	13911	13921	13936	13948	13960	13972	13984	13996	1360
1370	14009	14021	14033	14045	14057	14069	14081	14094	14106	14118	1370
1380	14130	14142	14154	14166	14178	14191	14203	14215	14227	14239	1380
1390	14251	14263	14276	14288	14300	14312	14324	14336	14348	14360	1390

Type S

JIS C 1602-1995 (Conform to IEC 584-1(1977), IEC 584-2(1982))

Unit μV

Temperature (°C)	0	1	2	3	4	5	6	7	8	9	Temperature (°C)
1400	14373	14385	14397	14409	14421	14433	14445	14457	14470	14482	1400
1410	14494	14506	14518	14530	14542	14554	14567	14579	14591	14603	1410
1420	14615	14627	14639	14651	14664	14676	14688	14700	14712	14724	1420
1430	14736	14748	14760	14773	14785	14797	14809	14821	14833	14845	1430
1440	14857	14869	14881	14894	14906	14918	14930	14942	14954	14966	1440
1450	14978	14990	15002	15015	15027	15039	15051	15063	15075	15087	1450
1460	15099	15111	15123	15135	15148	15160	15172	15184	15196	15208	1460
1470	15220	15232	15244	15256	15268	15280	15292	15304	15317	15329	1470
1480	15341	15353	15365	15377	15389	15401	15413	15425	15437	15449	1480
1490	15461	15473	15485	15497	15509	15521	15534	15546	15558	15570	1490
1500	15582	15594	15606	15618	15630	15642	15654	15666	15678	15690	1500
1510	15702	15714	15726	15738	15750	15762	15774	15786	15798	15810	1510
1520	15822	15834	15846	15858	15870	15882	15894	15906	15918	15930	1520
1530	15942	15954	15966	15978	15990	16002	16014	16026	16038	16050	1530
1540	16062	16074	16086	16098	16110	16122	16134	16146	16158	16170	1540
1550	16182	16194	16205	16217	16229	16241	16253	16265	16277	16289	1550
1560	16301	16313	16325	16337	16349	16361	16373	16385	16396	16408	1560
1570	16420	16432	16444	16456	16468	16480	16492	16504	16516	16527	1570
1580	16539	16551	16563	16575	16587	16599	16611	16623	16634	16646	1580
1590	16658	16670	16682	16694	16706	16718	16729	16741	16753	16765	1590
1600	16777	16789	16801	16812	16824	16836	16848	16860	16872	16883	1600
1610	16895	16907	16919	16931	16943	16954	16966	16978	16990	17002	1610
1620	17013	17025	17037	17049	17061	17072	17084	17096	17108	17120	1620
1630	17131	17143	17155	17167	17178	17190	17202	17214	17225	17237	1630
1640	17249	17261	17272	17284	17296	17308	17319	17331	17343	17355	1640
1650	17366	17378	17390	17401	17413	17425	17437	17448	17460	17472	1650
1660	17483	17495	17507	17518	17530	17542	17553	17565	17577	17588	1660
1670	17600	17612	17623	17635	17647	17658	17670	17682	17693	17705	1670
1680	17717	17728	17740	17751	17763	17775	17786	17798	17809	17821	1680
1690	17832	17844	17855	17867	17878	17890	17901	17913	17924	17936	1690
1700	17947	17959	17970	17982	17993	18004	18016	18027	18039	18050	1700
1710	18061	18073	18084	18095	18107	18118	18129	18140	18152	18163	1710
1720	18174	18185	18196	18208	18219	18230	18241	18252	18263	18274	1720
1730	18285	18297	18308	18319	18330	18341	18352	18362	18373	18384	1730
1740	18395	18406	18417	18428	18439	18449	18460	18471	18482	18493	1740
1750	18503	18514	18525	18535	18546	18557	18567	18578	18588	18599	1750
1760	18609	18620	18630	18641	18651	18661	18672	18682	18693	18703	1760

REMARK

Standard contact temperature is 0 °C.

Appendix 3.4 Standard Thermal Electromotive Force of K

Type K
Unit μV

JIS C 1602-1995 (Conform to IEC 584-1(1977), IEC 584-2(1982))

Temperature (°C)	0	-1	-2	-3	-4	-5	-6	-7	-8	-9	Temperature (°C)
-270	-6458										-270
-260	-6441	-6444	-6446	-6448	-6450	-6452	-6453	-6455	-6456	-6457	-260
-250	-6404	-6408	-6413	-6417	-6421	-6425	-6429	-6432	-6435	-6438	-250
-240	-6344	-6351	-6358	-6364	-6370	-6377	-6382	-6388	-6393	-6399	-240
-230	-6262	-6271	-6280	-6289	-6297	-6306	-6314	-6322	-6329	-6337	-230
-220	-6158	-6170	-6181	-6192	-6202	-6213	-6223	-6233	-6243	-6252	-220
-210	-6035	-6048	-6061	-6074	-6087	-6099	-6111	-6123	-6135	-6147	-210
-200	-5891	-5907	-5922	-5936	-5951	-5965	-5980	-5994	-6007	-6021	-200
-190	-5730	-5747	-5763	-5780	-5797	-5813	-5829	-5845	-5861	-5876	-190
-180	-5550	-5569	-5588	-5606	-5624	-5642	-5660	-5678	-5695	-5713	-180
-170	-5354	-5374	-5395	-5415	-5435	-5454	-5474	-5493	-5512	-5531	-170
-160	-5141	-5163	-5185	-5207	-5228	-5250	-5271	-5292	-5313	-5333	-160
-150	-4913	-4936	-4960	-4983	-5006	-5029	-5052	-5074	-5097	-5119	-150
-140	-4669	-4694	-4719	-4744	-4768	-4793	-4817	-4841	-4865	-4889	-140
-130	-4411	-4437	-4463	-4490	-4516	-4542	-4567	-4593	-4618	-4644	-130
-120	-4138	-4166	-4194	-4221	-4249	-4276	-4303	-4330	-4357	-4384	-120
-110	-3852	-3882	-3911	-3939	-3968	-3997	-4025	-4054	-4082	-4110	-110
-100	-3554	-3584	-3614	-3645	-3675	-3705	-3734	-3764	-3794	-3823	-100
-90	-3243	-3274	-3306	-3337	-3368	-3400	-3431	-3462	-3492	-3523	-90
-80	-2920	-2953	-2986	-3018	-3050	-3083	-3115	-3147	-3179	-3211	-80
-70	-2587	-2620	-2654	-2688	-2721	-2755	-2788	-2821	-2854	-2887	-70
-60	-2243	-2278	-2312	-2347	-2382	-2416	-2450	-2485	-2519	-2553	-60
-50	-1889	-1925	-1961	-1996	-2032	-2067	-2103	-2138	-2173	-2208	-50
-40	-1527	-1564	-1600	-1637	-1673	-1709	-1745	-1782	-1818	-1854	-40
-30	-1156	-1194	-1231	-1268	-1305	-1343	-1380	-1417	-1453	-1490	-30
-20	-778	-816	-854	-892	-930	-968	-1006	-1043	-1081	-1119	-20
-10	-392	-431	-470	-508	-547	-586	-624	-663	-701	-739	-10
0	0	-39	-79	-118	-157	-197	-236	-275	-314	-353	0
Temperature (°C)	0	1	2	3	4	5	6	7	8	9	Temperature (°C)
0	0	39	79	119	158	198	238	277	317	357	0
10	397	437	477	517	557	597	637	677	718	758	10
20	798	838	879	919	960	1000	1041	1081	1122	1163	20
30	1203	1244	1285	1326	1366	1407	1448	1489	1530	1571	30
40	1612	1653	1694	1735	1776	1817	1858	1899	1941	1982	40
50	2023	2064	2106	2147	2188	2230	2271	2312	2354	2395	50
60	2436	2478	2519	2561	2602	2644	2685	2727	2768	2810	60
70	2851	2893	2934	2976	3017	3059	3100	3142	3184	3225	70
80	3267	3308	3350	3391	3433	3474	3516	3557	3599	3640	80
90	3682	3723	3765	3806	3848	3889	3931	3972	4013	4055	90
100	4096	4138	4179	4220	4262	4303	4344	4385	4427	4468	100
110	4509	4550	4591	4633	4674	4715	4756	4797	4838	4879	110
120	4920	4961	5002	5043	5084	5124	5165	5206	5247	5288	120
130	5328	5369	5410	5450	5491	5532	5572	5613	5653	5694	130
140	5735	5775	5815	5856	5896	5937	5977	6017	6058	6098	140

Type K

JIS C 1602-1995 (Conform to IEC 584-1(1977), IEC 584-2(1982))

Unit μV

Temperature (°C)	0	1	2	3	4	5	6	7	8	9	Temperature (°C)
150	6138	6179	6219	6259	6299	6339	6380	6420	6460	6500	150
160	6540	6580	6620	6660	6701	6741	6781	6821	6861	6901	160
170	6941	6981	7021	7060	7100	7140	7180	7220	7260	7300	170
180	7340	7380	7420	7460	7500	7540	7579	7619	7659	7699	180
190	7739	7779	7819	7859	7899	7939	7979	8019	8059	8099	190
200	8138	8178	8218	8258	8298	8338	8378	8418	8458	8499	200
210	8539	8579	8619	8659	8699	8739	8779	8819	8860	8900	210
220	8940	8980	9020	9061	9101	9141	9181	9222	9262	9302	220
230	9343	9383	9423	9464	9504	9545	9585	9626	9666	9707	230
240	9747	9788	9828	9869	9909	9950	9991	1031	10072	10113	240
250	10153	10194	10235	10276	10316	10357	10398	10439	10480	10520	250
260	10561	10602	10643	10684	10725	10766	10807	10848	10889	10930	260
270	10971	11012	11053	11094	11135	11176	11217	11259	11300	11341	270
280	11382	11423	11465	11506	11547	11588	11630	11671	11712	11753	280
290	11795	11836	11877	11919	11960	12001	12043	12084	12126	12167	290
300	12209	12250	12291	12333	12374	12416	12457	12499	12540	12582	300
310	12624	12665	12707	12748	12790	12831	12873	12915	12956	12998	310
320	13040	13081	13123	13165	13206	13248	13290	13334	13373	13415	320
330	13457	13498	13540	13582	13624	13665	13707	13749	13791	13833	330
340	13874	13916	13958	14000	14042	14084	14126	14167	14209	14251	340
350	14293	14335	14377	14419	14461	14503	14545	14587	14629	14671	350
360	14713	14755	14797	14839	14881	14923	14965	15007	15049	15091	360
370	15133	15175	15217	15259	15301	15343	15385	15427	15469	15511	370
380	15554	15596	15638	15680	15722	15764	15806	15849	15891	15933	380
390	15975	16017	16059	16102	16144	16186	16228	16270	16313	16355	390
400	16397	16439	16482	16524	16566	16608	16651	16693	16735	16778	400
410	16820	16862	16904	16947	16989	17031	17074	17116	17158	17201	410
420	17243	17285	17328	17370	17413	17455	17497	17540	17582	17624	420
430	17667	17709	17752	17794	17837	17879	17921	17964	18006	18049	430
440	18091	18134	18176	18218	18261	18303	18346	18388	18431	18473	440
450	18516	18558	18601	18643	18686	18728	18771	18813	18856	18898	450
460	18941	18983	19026	19068	19111	19154	19196	19239	19281	19324	460
470	19366	19409	19451	19494	19537	19579	19622	19664	19707	19750	470
480	19792	19835	19877	19920	19962	20005	20048	20090	20133	20175	480
490	20218	20261	20303	20346	20389	20431	20474	20516	20559	20602	490
500	20644	20687	20730	20772	20815	20857	20900	20943	20985	21028	500
510	21071	21113	21156	21199	21241	21284	21326	21369	21412	21454	510
520	21497	21540	21582	21625	21668	21710	21753	21796	21838	21881	520
530	21924	21966	22009	22052	22094	22137	22179	22222	22265	22307	530
540	22350	22393	22435	22478	22521	22563	22606	22649	22691	22734	540
550	22776	22819	22862	22904	22947	22990	23032	23075	23117	23160	550
560	23203	23245	23288	23331	23373	23416	23458	23501	23544	23586	560
570	23629	23671	23714	23757	23799	23842	23884	23927	23970	24012	570
580	24055	24097	24140	24182	24225	24267	24310	24353	24395	24438	580
590	24480	24523	24565	24608	24650	24693	24735	24778	24820	24863	590

Type K

JIS C 1602-1995 (Conform to IEC 584-1(1977), IEC 584-2(1982))

Unit μV

Temperature (°C)	0	1	2	3	4	5	6	7	8	9	Temperature (°C)
600	24905	24948	24990	25033	25075	25118	25160	25203	25245	25288	600
610	25330	25373	25415	25458	25500	25543	25585	25627	25670	25712	610
620	25755	25797	25840	25882	25924	25967	26009	26052	26094	26136	620
630	26179	26221	26263	26306	26348	26390	26433	26475	26517	26560	630
640	26602	26644	26687	26729	26771	26814	26856	26898	26940	26983	640
650	27025	27067	27109	27152	27194	27236	27278	27320	27363	27405	650
660	27447	27489	27531	27574	27616	27658	27700	27742	27784	27826	660
670	27869	27911	27953	27995	28037	28079	28121	28163	28205	28247	670
680	28289	28332	28374	28416	28458	28500	28542	28584	28626	28668	680
690	28710	28752	28794	28835	28877	28919	28961	29003	29045	29087	690
700	29129	29171	29213	29255	29297	29338	29380	29422	29464	29506	700
710	29548	29589	29631	29673	29715	29757	29798	29840	29882	29924	710
720	29965	30007	30049	30090	30132	30174	30216	30257	30299	30341	720
730	30382	30424	30466	30507	30549	30590	30632	30674	30715	30757	730
740	30798	30840	30881	30923	30964	31006	31047	31089	31130	31172	740
750	31213	31255	31296	31338	31379	31421	31462	31504	31545	31586	750
760	31628	31669	31710	31752	31793	31834	31876	31917	31958	32000	760
770	32041	32082	32124	32165	32206	32247	32289	32330	32371	32412	770
780	32453	32495	32536	32577	32618	32659	32700	32742	32783	32824	780
790	32865	32906	32947	32988	33029	33070	33111	33152	33193	33234	790
800	33275	33316	33357	33398	33439	33480	33521	33562	33603	33644	800
810	33685	33726	33767	33808	33848	33889	33930	33971	34012	34053	810
820	34093	34134	34175	34216	34257	34297	34338	34379	34420	34460	820
830	34501	34542	34582	34623	34664	34704	34745	34786	34826	34867	830
840	34908	34948	34989	35029	35070	35110	35151	35192	35232	35273	840
850	35313	35354	35394	35435	35475	35516	35556	35596	35637	35677	850
860	35718	35758	35798	35839	35879	35920	35960	36000	36041	36081	860
870	36121	36162	36202	36242	36282	36323	36363	36403	36443	36484	870
880	36524	36564	36604	36644	36685	36725	36765	36805	36845	36885	880
890	36925	36965	37006	37046	37086	37126	37166	37206	37246	37286	890
900	37326	37366	37406	37446	37486	37526	37566	37606	37646	37686	900
910	37725	37765	37805	37845	37885	37925	37965	38005	38044	38084	910
920	38124	38164	38204	38243	38283	38323	38363	38402	38442	38482	920
930	38522	38561	38601	38641	38680	38720	38760	38799	38839	38878	930
940	38918	38958	38997	39037	39076	39116	39155	39195	39235	39274	940
950	39314	39353	39393	39432	39471	39511	39550	39590	39629	39669	950
960	39708	39747	39787	39826	39866	39905	39944	39984	40023	40062	960
970	40101	40141	40180	40219	40259	40298	40337	40376	40415	40455	970
980	40494	40533	40572	40611	40651	40690	40729	40768	40807	40846	980
990	40885	40924	40963	41002	41042	41081	41120	41159	41198	41237	990
1000	41276	41315	41354	41393	41431	41470	41509	41548	41587	41626	1000
1010	41665	41704	41743	41781	41820	41859	41898	41937	41976	42014	1010
1020	42053	42092	42131	42169	42208	42247	42286	42324	42363	42402	1020
1030	42440	42479	42518	42556	42595	42633	42672	42711	42749	42788	1030
1040	42826	42865	42903	42942	42980	43019	43057	43096	43134	43173	1040

Type K

JIS C 1602-1995 (Conform to IEC 584-1(1977), IEC 584-2(1982))

Unit μV

Temperature (°C)	0	1	2	3	4	5	6	7	8	9	Temperature (°C)
1050	43211	43250	43288	43327	43365	43403	43442	43480	43518	43557	1050
1060	43595	43633	43672	43710	43748	43787	43825	43863	43901	43940	1060
1070	43978	44016	44054	44092	44130	44169	44207	44245	44283	44321	1070
1080	44359	44397	44435	44473	44512	44550	44588	44626	44664	44702	1080
1090	44740	44778	44816	44853	44891	44929	44967	45005	45043	45081	1090
1100	45119	45157	45194	45232	45270	45308	45346	45383	45421	45459	1100
1110	45497	45534	45572	45610	45647	45685	45723	45760	45798	45836	1110
1120	45873	45911	45948	45986	46024	46061	46099	46136	46174	46211	1120
1130	46249	46286	46324	46361	46398	46436	46473	46511	46548	46585	1130
1140	46623	46660	46697	46735	46772	46809	46847	46884	46921	46958	1140
1150	46995	47033	47070	47107	47144	47181	47218	47256	47293	47330	1150
1160	47367	47404	47441	47478	47515	47552	47589	47626	47663	47700	1160
1170	47737	47774	47811	47848	47884	47921	47958	47995	48032	48069	1170
1180	48105	48142	48179	48216	48252	48289	48326	48363	48399	48436	1180
1190	48473	48509	48546	48582	48619	48656	48692	48729	48765	48802	1190
1200	48838	48875	48911	48948	48984	49021	49057	49093	49130	49166	1200
1210	49202	49239	49275	49311	49348	49384	49420	49456	49493	49529	1210
1220	49565	49601	49637	49674	49710	49746	49782	49818	49854	49890	1220
1230	49926	49962	49998	50034	50070	50106	50142	50178	50214	50250	1230
1240	50286	50322	50358	50393	50429	50465	50501	50537	50572	50608	1240
1250	50644	50680	50715	50751	50787	50822	50858	50894	50929	50965	1250
1260	51000	51036	51071	51107	51142	51178	51213	51249	51284	51320	1260
1270	51355	51391	51426	51461	51497	51532	51567	51603	51638	51673	1270
1280	51708	51744	51779	51814	51849	51885	51920	51955	51990	52025	1280
1290	52060	52095	52130	52165	52200	52235	52270	52305	52340	52375	1290
1300	52410	52445	52480	52515	52550	52585	52620	52654	52689	52724	1300
1310	52759	52794	52828	52863	52898	52932	52967	53002	53037	53071	1310
1320	53106	53140	53175	53210	53244	53279	53313	53348	53382	53417	1320
1330	53451	53486	53520	53555	53589	53623	53658	53692	53727	53761	1330
1340	53795	53830	53864	53898	53932	53967	54001	54035	54069	54104	1340
1350	54138	54172	54206	54240	54274	54308	54343	54377	54411	54445	1350
1360	54479	54513	54547	54581	54615	54649	54683	54717	54751	54785	1360
1370	54819	54852	54886								1370

REMARK

Standard contact temperature is 0 °C.

Appendix 3.5 Standard Thermal Electromotive Force of E

Type E
Unit μV

JIS C 1602-1995 (Conform to IEC 584-1(1977), IEC 584-2(1982))

Temperature (°C)	0	-1	-2	-3	-4	-5	-6	-7	-8	-9	Temperature (°C)
-270	-9835										-270
-260	-9797	-9802	-9808	-9813	-9817	-9821	-9825	-9828	-9831	-9833	-260
-250	-9718	-9728	-9737	-9746	-9754	-9762	-9770	-9777	-9784	-9790	-250
-240	-9604	-9617	-9630	-9642	-9654	-9666	-9677	-9688	-9698	-9709	-240
-230	-9455	-9471	-9487	-9503	-9519	-9534	-9548	-9563	-9577	-9591	-230
-220	-9274	-9293	-9313	-9331	-9350	-9368	-9386	-9404	-9421	-9438	-220
-210	-9063	-9085	-9107	-9129	-9151	-9172	-9193	-9214	-9234	-9254	-210
-200	-8825	-8850	-8874	-8899	-8923	-8947	-8971	-8994	-9017	-9040	-200
-190	-8561	-8588	-8616	-8643	-8669	-8696	-8722	-8748	-8774	-8799	-190
-180	-8273	-8303	-8333	-8362	-8391	-8420	-8449	-8477	-8505	-8533	-180
-170	-7963	-7995	-8027	-8059	-8090	-8121	-8152	-8183	-8213	-8243	-170
-160	-7632	-7666	-7700	-7733	-7767	-7800	-7833	-7866	-7899	-7931	-160
-150	-7279	-7315	-7351	-7387	-7423	-7458	-7493	-7528	-7563	-7597	-150
-140	-6907	-6945	-6983	-7021	-7058	-7096	-7133	-7170	-7206	-7243	-140
-130	-6516	-6556	-6596	-6636	-6675	-6714	-6753	-6792	-6831	-6869	-130
-120	-6107	-6149	-6191	-6232	-6273	-6314	-6355	-6396	-6436	-6476	-120
-110	-5681	-5724	-5767	-5810	-5853	-5896	-5939	-5981	-6023	-6065	-110
-100	-5237	-5282	-5327	-5372	-5417	-5461	-5505	-5549	-5593	-5637	-100
-90	-4777	-4824	-4871	-4917	-4963	-5009	-5055	-5101	-5147	-5192	-90
-80	-4302	-4350	-4398	-4446	-4494	-4542	-4589	-4636	-4687	-4731	-80
-70	-3811	-3861	-3911	-3960	-4009	-4058	-4107	-4156	-4205	-4254	-70
-60	-3306	-3357	-3408	-3459	-3510	-3561	-3611	-3661	-3711	-3761	-60
-50	-2787	-2840	-2892	-2944	-2996	-3048	-3100	-3152	-3204	-3255	-50
-40	-2255	-2309	-2362	-2416	-2469	-2523	-2576	-2629	-2682	-2735	-40
-30	-1709	-1765	-1820	-1874	-1929	-1984	-2038	-2093	-2147	-2201	-30
-20	-1152	-1208	-1264	-1320	-1376	-1432	-1488	-1543	-1599	-1654	-20
-10	-582	-639	-697	-754	-811	-868	-925	-982	-1039	-1095	-10
0	0	-59	-117	-176	-234	-292	-350	-408	-466	-524	0
Temperature (°C)	0	1	2	3	4	5	6	7	8	9	Temperature (°C)
0	0	59	118	176	235	294	354	413	472	532	0
10	591	651	711	770	830	890	950	1010	1071	1131	10
20	1192	1252	1313	1373	1434	1495	1556	1617	1678	1740	20
30	1801	1862	1924	1986	2047	2109	2171	2233	2295	2357	30
40	2420	2482	2545	2607	2670	2733	2795	2858	2921	2984	40
50	3048	3111	3174	3238	3301	3365	3429	3492	3556	3620	50
60	3685	3749	3813	3877	3942	4006	4071	4136	4200	4265	60
70	4330	4395	4460	4526	4591	4656	4722	4788	4853	4919	70
80	4985	5051	5117	5183	5249	5315	5382	5448	5514	5581	80
90	5648	5714	5781	5848	5915	5982	6049	6117	6184	6251	90
100	6319	6386	6454	6522	6590	6658	6725	6794	6862	6930	100
110	6998	7066	7135	7203	7272	7341	7409	7478	7547	7616	110
120	7685	7754	7823	7892	7962	8031	8101	8170	8240	8309	120
130	8379	8449	8519	8589	8659	8729	8799	8869	8940	9010	130
140	9081	9151	9222	9292	9363	9434	9505	9576	9647	9718	140
150	9789	9860	9931	10003	10074	10145	10217	10288	10360	10432	150
160	10503	10575	10647	10719	10791	10863	10935	11007	11080	11152	160
170	11224	11297	11369	11442	11514	11587	11660	11733	11805	11878	170
180	11951	12024	12097	12170	12243	12317	12390	12463	12537	12610	180
190	12684	12757	12831	12904	12978	13052	13126	13199	13273	13347	190

Type E

JIS C 1602-1995 (Conform to IEC 584-1(1977), IEC 584-2(1982))

Unit μV

Temperature (°C)	0	1	2	3	4	5	6	7	8	9	Temperature (°C)
200	13421	13495	13569	13644	13718	13792	13866	13941	14015	14090	200
210	14164	14239	14313	14388	14463	14537	14612	14687	14762	14837	210
220	14912	14987	15062	15137	15212	15287	15362	15438	15513	15588	220
230	15664	15739	15815	15890	15966	16044	16117	16193	16269	16344	230
240	16420	16496	16572	16648	16724	16800	16876	16952	17028	17104	240
250	17181	17257	17333	17409	17486	17562	17639	17715	17792	17868	250
260	17945	18021	18098	18175	18252	18328	18405	18482	18559	18636	260
270	18713	18790	18867	18944	19021	19098	19175	19252	19330	19407	270
280	19484	19561	19639	19716	19791	19871	19948	20026	20103	20181	280
290	20259	20336	20414	20492	20569	20647	20725	20803	20880	20958	290
300	21036	21114	21192	21270	21348	21426	21504	21582	21660	21739	300
310	21817	21895	21973	22051	22130	22208	22286	22365	22443	22522	310
320	22600	22678	22757	22835	22914	22993	23071	23150	23228	23307	320
330	23386	23464	23543	23622	23701	23780	23858	23937	24016	24095	330
340	24174	24253	24332	24411	24490	24569	24648	24727	24806	24885	340
350	24964	25044	25123	25202	25281	25360	25440	25519	25598	25678	350
360	25757	25836	25916	25995	26075	26154	26233	26313	26392	26472	360
370	26552	26631	26711	26790	26870	26950	27029	27109	27189	27268	370
380	27348	27428	27507	27587	27667	27747	27827	27907	27986	28066	380
390	28146	28226	28306	28386	28466	28546	28626	28706	28786	28866	390
400	28946	29026	29106	29186	29266	29346	29427	29507	29587	29667	400
410	29747	29827	29908	29988	30068	30148	30229	30309	30389	30470	410
420	30550	30630	30711	30791	30871	30952	31032	31112	31193	31273	420
430	31354	31434	31515	31595	31676	31756	31837	31917	31998	32078	430
440	32159	32239	32320	32400	32481	32562	32642	32723	32803	32884	440
450	32965	33045	33126	33207	33287	33368	33449	33529	33610	33691	450
460	33772	33852	33933	34014	34095	34175	34256	34337	34418	34498	460
470	34579	34660	34741	34822	34902	34983	35064	35145	35226	35307	470
480	35387	35468	35549	35630	35711	35792	35873	35954	36034	36115	480
490	36196	36277	36358	36439	36520	36601	36682	36763	36843	36924	490
500	37005	37086	37167	37248	37329	37410	37491	37572	37653	37734	500
510	37815	37896	37977	38058	38139	38220	38300	38381	38462	38543	510
520	38624	38705	38786	38867	38948	39029	39110	39191	39272	39353	520
530	39434	39515	39596	39677	39758	39839	39920	40001	40082	40163	530
540	40243	40324	40405	40486	40567	40648	40729	40810	40891	40972	540
550	41053	41134	41215	41296	41377	41457	41538	41619	41700	41781	550
560	41862	41943	42024	42105	42185	42266	42347	42428	42509	42590	560
570	42671	42751	42832	42913	42994	43075	43156	43236	43317	43398	570
580	43479	43560	43640	43721	43802	43883	43963	44044	44125	44206	580
590	44285	44367	44448	44529	44609	44690	44771	44851	44932	45013	590
600	45093	45174	45255	45335	45416	45497	45577	45658	45738	45819	600
610	45900	45980	46064	46141	46222	46302	46383	46463	46544	46624	610
620	46705	46785	46866	46946	47027	47107	47188	47268	47349	47429	620
630	47509	47590	47670	47751	47831	47911	47992	48072	48152	48233	630
640	48313	48393	48474	48554	48634	48715	48795	48875	48955	49035	640
650	49116	49196	49276	49356	49436	49517	49597	49677	49757	49837	650
660	49917	49997	50077	50157	50238	50318	50398	50478	50558	50638	660
670	50718	50798	50878	50958	51038	51118	51197	51277	51357	51437	670
680	51517	51597	51677	51757	51837	51916	51996	52076	52156	52236	680
690	52315	52395	52475	52555	52634	52714	52794	52873	52953	53033	690

Type E

JIS C 1602-1995 (Conform to IEC 584-1(1977), IEC 584-2(1982))

Unit μV

Temperature (°C)	0	1	2	3	4	5	6	7	8	9	Temperature (°C)
700	53112	53192	53272	53351	53431	53510	53590	53670	53749	53829	700
710	53908	53988	54067	54147	54226	54306	54385	54465	54544	54624	710
720	54703	54782	54862	54941	55021	55100	55179	55259	55338	55417	720
730	55497	55576	55655	55734	55814	55893	55972	56051	56131	56210	730
740	56289	56368	56447	56526	56606	56685	56764	56843	56922	57001	740
750	57080	57159	57238	57317	57396	57475	57554	57633	57712	57791	750
760	57870	57949	58028	58107	58186	58265	58343	58422	58501	58580	760
770	58659	58738	58816	58895	58974	59053	59131	59210	59289	59367	770
780	59446	59525	59604	59682	59761	59839	59918	59997	60075	60154	780
790	60232	60311	60390	60468	60547	60625	60704	60782	60860	60939	790
800	61017	61096	61174	61253	61331	61409	61488	61566	61644	61723	800
810	61801	61879	61958	62036	62114	62192	62271	62349	62427	62505	810
820	62583	62662	62740	62818	62896	62974	63052	63130	63208	63286	820
830	63364	63442	63520	63598	63676	63754	63832	63910	63988	64066	830
840	64144	64222	64300	64377	64455	64533	64611	64689	64766	64844	840
850	64922	65000	65077	65155	65233	65310	65388	65465	65543	65621	850
860	65698	65776	65853	65931	66008	66086	66163	66241	66318	66396	860
870	66473	66550	66628	66705	66782	66860	66937	67014	67092	67169	870
880	67246	67323	67400	67478	67555	67632	67709	67786	67863	67940	880
890	68017	68094	68174	68248	68325	68402	68479	68556	68633	68710	890
900	68787	68863	68940	69017	69094	69171	69247	69324	69401	69477	900
910	69554	69631	69707	69784	69860	69937	70013	70090	70166	70243	910
920	70319	70396	70472	70548	70625	70701	70777	70854	70930	71006	920
930	71082	71159	71235	71311	71387	71463	71539	71615	71692	71768	930
940	71844	71920	71996	72072	72147	72223	72299	72375	72454	72527	940
950	72603	72678	72754	72830	72906	72981	73057	73133	73208	73284	950
960	73360	73435	73511	73586	73662	73738	73813	73889	73964	74040	960
970	74115	74190	74266	74341	74417	74492	74567	74643	74718	74793	970
980	74869	74944	75019	75095	75170	75245	75320	75395	75471	75546	980
990	75621	75696	75771	75847	75922	75997	76072	76147	76223	76298	990
1000	76373										1000

Appendix 3.6 Standard Thermal Electromotive Force of J

Type J

JIS C 1602-1995 (Conform to IEC 584-1(1977), IEC 584-2(1982))

Unit μV

Temperature (°C)	0	-1	-2	-3	-4	-5	-6	-7	-8	-9	Temperature (°C)
-210	-8095										-210
-200	-7890	-7912	-7934	-7955	-7976	-7996	-8017	-8037	-8057	-8076	-200
-190	-7659	-7683	-7707	-7731	-7755	-7778	-7801	-7824	-7846	-7868	-190
-180	-7403	-7429	-7456	-7482	-7508	-7534	-7559	-7585	-7610	-7634	-180
-170	-7123	-7152	-7181	-7209	-7237	-7265	-7293	-7321	-7348	-7376	-170
-160	-6821	-6853	-6883	-6914	-6944	-6975	-7005	-7035	-7064	-7094	-160
-150	-6500	-6533	-6566	-6598	-6631	-6663	-6695	-6727	-6759	-6790	-150
-140	-6159	-6194	-6229	-6263	-6298	-6332	-6366	-6400	-6433	-6467	-140
-130	-5801	-5838	-5874	-5910	-5946	-5982	-6018	-6054	-6089	-6124	-130
-120	-5426	-5465	-5503	-5541	-5578	-5616	-5653	-5690	-5727	-5764	-120
-110	-5037	-5076	-5116	-5155	-5194	-5233	-5272	-5311	-5350	-5388	-110
-100	-4633	-4674	-4714	-4755	-4796	-4836	-4877	-4917	-4957	-4997	-100
-90	-4215	-4257	-4300	-4342	-4384	-4425	-4467	-4509	-4550	-4591	-90
-80	-3786	-3829	-3872	-3916	-3959	-4002	-4045	-4088	-4130	-4173	-80
-70	-3344	-3389	-3434	-3478	-3522	-3566	-3610	-3654	-3698	-3742	-70
-60	-2893	-2938	-2984	-3029	-3075	-3120	-3165	-3210	-3255	-3300	-60
-50	-2431	-2478	-2524	-2571	-2617	-2663	-2709	-2755	-2801	-2847	-50
-40	-1961	-2008	-2055	-2103	-2150	-2197	-2244	-2291	-2338	-2385	-40
-30	-1482	-1530	-1578	-1626	-1674	-1722	-1770	-1818	-1865	-1913	-30
-20	-995	-1044	-1093	-1142	-1190	-1239	-1288	-1336	-1385	-1433	-20
-10	-501	-550	-600	-650	-699	-749	-798	-847	-896	-946	-10
0	0	-50	-101	-151	-201	-251	-301	-351	-401	-451	0
Temperature (°C)	0	1	2	3	4	5	6	7	8	9	Temperature (°C)
0	0	50	101	151	202	253	303	354	405	456	0
10	507	558	609	660	711	762	814	865	916	958	10
20	1019	1071	1122	1174	1226	1277	1329	1381	1433	1485	20
30	1537	1589	1641	1693	1745	1797	1849	1902	1954	2006	30
40	2059	2111	2164	2216	2269	2322	2374	2427	2480	2532	40
50	2585	2638	2691	2744	2797	2850	2903	2956	3009	3062	50
60	3116	3169	3222	3275	3329	3382	3436	3489	3543	3596	60
70	3650	3703	3757	3810	3864	3918	3971	4025	4079	4133	70
80	4187	4240	4294	4348	4402	4456	4510	4564	4618	4672	80
90	4726	4781	4835	4889	4943	4997	5052	5106	5160	5215	90
100	5269	5323	5378	5432	5487	5541	5595	5650	5705	5759	100
110	5814	5868	5923	5977	6032	6087	6141	6196	6251	6306	110
120	6360	6415	6470	6525	6579	6634	6689	6744	6799	6854	120
130	6909	6964	7019	7074	7129	7184	7239	7294	7349	7404	130
140	7459	7514	7569	7624	7679	7734	7789	7844	7900	7955	140
150	8010	8065	8120	8175	8231	8286	8341	8396	8452	8507	150
160	8562	8618	8673	8728	8783	8839	8894	8949	9005	9060	160
170	9115	9171	9226	9282	9337	9392	9448	9503	9559	9614	170
180	9669	9725	9780	9836	9891	9947	10002	10057	10113	10168	180
190	10224	10279	10335	10390	10446	10501	10557	10612	10668	10723	190

Type J

JIS C 1602-1995 (Conform to IEC 584-1(1977), IEC 584-2(1982))

Unit μV

Temperature (°C)	0	1	2	3	4	5	6	7	8	9	Temperature (°C)
200	10779	10834	10890	10945	11001	11056	11112	11167	11223	11278	200
210	11334	11389	11445	11501	11556	11612	11667	11723	11778	11834	210
220	11889	11945	12000	12056	12111	12167	12222	12278	12334	12389	220
230	12445	12500	12556	12611	12667	12722	12778	12833	12889	12944	230
240	13000	13056	13111	13167	13222	13278	13333	13389	13444	13500	240
250	13555	13611	13666	13722	13777	13833	13888	13944	13999	14055	250
260	14110	14166	14221	14277	14332	14388	14443	14499	14554	14609	260
270	14665	14720	14776	14831	14887	14942	14998	15053	15109	15164	270
280	15219	15275	15330	15386	15441	15496	15552	15607	15663	15718	280
290	15773	15829	15884	15940	15995	16050	16106	16161	16216	16272	290
300	16327	16383	16438	16493	16549	16604	16659	16715	16770	16825	300
310	16881	16936	16991	17046	17102	17157	17212	17268	17323	17378	310
320	17434	17489	17544	17599	17655	17710	17765	17820	17876	17931	320
330	17986	18041	18097	18152	18207	18262	18318	18373	18428	18483	330
340	18538	18594	18649	18704	18759	18814	18870	18925	18980	19035	340
350	19090	19146	19201	19256	19311	19366	19422	19477	19532	19587	350
360	19642	19697	19753	19808	19863	19918	19973	20028	20083	20139	360
370	20194	20249	20304	20359	20414	20469	20525	20580	20635	20690	370
380	20745	20800	20855	20911	20966	21021	21076	21131	21186	21241	380
390	21297	21352	21407	21462	21517	21572	21627	21683	21738	21793	390
400	21848	21903	21958	22014	22069	22124	22179	22234	22289	22345	400
410	22400	22455	22510	22565	22620	22676	22731	22786	22841	22896	410
420	22952	23007	23062	23117	23172	23228	23283	23338	23393	23449	420
430	23504	23559	23614	23670	23725	23780	23835	23891	23946	24001	430
440	24057	24112	24167	24223	24278	24333	24389	24444	24499	24555	440
450	24610	24665	24721	24776	24832	24887	24943	24998	25053	25109	450
460	25164	25220	25275	25331	25386	25442	25497	25553	25608	25664	460
470	25720	25775	25831	25886	25942	25998	26053	26109	26165	26220	470
480	26276	26332	26387	26443	26499	26555	26610	26666	26722	26778	480
490	26834	26889	26945	27001	27057	27113	27169	27225	27281	27337	490
500	27393	27449	27505	27561	27617	27673	27729	27785	27841	27897	500
510	27953	28010	28066	28122	28178	28234	28291	28347	28403	28460	510
520	28516	28572	28629	28685	28741	28798	28854	28911	28967	29024	520
530	29080	29137	29194	29250	29307	29363	29420	29477	29534	29590	530
540	29647	29704	29761	29818	29874	29931	29988	30045	30102	30159	540
550	30216	30273	30330	30387	30444	30502	30559	30616	30673	30730	550
560	30788	30845	30902	30960	31017	31074	31132	31189	31247	31304	560
570	31362	31419	31477	31535	31592	31650	31708	31766	31823	31881	570
580	31939	31997	32055	32113	32171	32229	32287	32345	32403	32461	580
590	32519	32577	32636	32694	32752	32810	32869	32927	32985	33044	590
600	33102	33161	33219	33278	33337	33395	33454	33513	33571	33630	600
610	33689	33748	33807	33866	33925	33984	34043	34102	34161	34220	610
620	34279	34338	34397	34457	34516	34575	34635	34694	34754	34813	620
630	34873	34932	34992	35051	35111	35171	35230	35290	35350	35410	630
640	35470	35530	35590	35650	35710	35770	35830	35890	35950	36010	640

Type J

JIS C 1602-1995 (Conform to IEC 584-1(1977), IEC 584-2(1982))

Unit μV

Temperature (°C)	0	1	2	3	4	5	6	7	8	9	Temperature (°C)
650	36071	36131	36191	36252	36312	36373	36433	36494	36554	36615	650
660	36675	36736	36797	36858	36918	36979	37040	37101	37162	37223	660
670	37284	37345	37406	37467	37528	37590	37651	37712	37773	37835	670
680	37896	37958	38019	38081	38142	38204	38265	38327	38389	38450	680
690	38512	38574	38636	38698	38760	38822	38884	38946	39008	39070	690
700	39132	39194	39256	39318	39381	39443	39505	39568	39630	39693	700
710	39755	39818	39880	39943	40005	40068	40131	40193	40256	40319	710
720	40382	40445	40508	40570	40633	40696	40759	40822	40886	40949	720
730	41012	41075	41138	41201	41265	41328	41391	41455	41518	41581	730
740	41645	41708	41772	41835	41899	41962	42026	42090	42153	42217	740
750	42281	42344	42408	42472	42536	42599	42663	42727	42791	42855	750
760	42919	42983	43047	43111	43175	43239	43303	43367	43431	43495	760
770	43559	43624	43688	43752	43817	43881	43945	44010	44074	44139	770
780	44203	44267	44332	44396	44461	44525	44590	44655	44719	44784	780
790	44848	44913	44977	45042	45107	45171	45236	45301	45365	45430	790
800	45494	45559	45624	45688	45753	45818	45882	45947	46011	46076	800
810	46141	46205	46270	46334	46399	46464	46528	46593	46657	46722	810
820	46786	46851	46915	46980	47044	47109	47173	47238	47302	47367	820
830	47431	47495	47560	47624	47688	47753	47817	47881	47946	48010	830
840	48074	48138	48202	48267	48331	48395	48459	48523	48587	48651	840
850	48715	48779	48843	48907	48971	49034	49098	49162	49226	49290	850
860	49353	49417	49481	49544	49608	49672	49735	49799	49862	49926	860
870	49989	50052	50116	50179	50243	50306	50369	50432	50495	50559	870
880	50622	50685	50748	50811	50874	50937	51000	51063	51126	51188	880
890	51251	51314	51377	51439	51502	51565	51627	51690	51752	51815	890
900	51877	51940	52002	52064	52127	52189	52251	22314	52376	52438	900
910	52500	52562	52624	52686	52748	52810	52872	52934	52996	53057	910
920	53119	53181	53243	53304	53366	53427	53489	53550	53612	53673	920
930	53735	53796	53857	53919	53980	54041	54102	54164	54225	54286	930
940	54347	54408	54469	54530	54591	54652	54713	54773	54834	54895	940
950	54956	55016	55077	55138	55198	55259	55319	55380	55440	55501	950
960	55561	55622	55682	55742	55803	55863	55923	55983	56043	56104	960
970	56164	56224	56284	56344	56404	56464	56524	56584	56643	56703	970
980	56763	56823	56883	56942	57002	57062	57121	57181	57240	57300	980
990	57360	57419	57479	57538	57597	57657	57716	57776	57835	57894	990
1000	57953	58013	58072	58131	58190	58249	58309	58368	58427	58486	1000
1010	58545	58604	58663	58722	58781	58840	58899	58957	59016	59075	1010
1020	59134	59193	59252	59310	59369	59428	59487	59545	59604	59663	1020
1030	59721	59780	59838	59897	59956	60014	60073	60131	60190	60248	1030
1040	60307	60365	60423	60482	60540	60599	60657	60715	60774	60832	1040
1050	60890	60949	61007	61065	61123	61182	61240	61298	61356	61415	1050
1060	61473	61531	61589	61647	61705	61763	61822	61880	61938	61996	1060
1070	62054	62112	62170	62228	62286	62344	62402	62460	62518	62576	1070
1080	62634	62692	62750	62808	62866	62924	62982	63040	63098	63156	1080
1090	63214	63271	63329	63387	63445	63503	63561	63619	63677	63734	1090

Type J

JIS C 1602-1995 (Conform to IEC 584-1(1977), IEC 584-2(1982))

Unit μV

Temperature (°C)	0	1	2	3	4	5	6	7	8	9	Temperature (°C)
1100	63792	63850	63908	63966	64024	64081	64139	64197	64255	64313	1100
1110	64370	64428	64486	64544	64602	64659	64717	64775	64833	64890	1110
1120	64948	65006	65064	65121	65179	65237	65295	65352	65410	65468	1120
1130	65525	65583	65641	65699	65756	65814	65872	65929	65987	66045	1130
1140	66102	66160	66218	66275	66333	66391	66448	66506	66564	66621	1140
1150	66679	66737	66794	66852	66910	66967	67025	67082	67140	67198	1150
1160	67255	67313	67370	67428	67486	67543	67601	67658	67716	67773	1160
1170	67831	67888	67946	68003	68061	68119	68176	68234	68291	68348	1170
1180	68406	68463	68521	68578	68636	68693	68751	68808	68865	68923	1180
1190	68980	69037	69095	69152	69209	69267	69324	69381	69439	69496	1190
1200	69553										1200

REMARK

Standard contact temperature is 0 °C.

Appendix 3.7 Standard Thermal Electromotive Force of T

Type T
Unit μV

JIS C 1602-1995 (Conform to IEC 584-1(1977), IEC 584-2(1982))

Temperature (°C)	0	-1	-2	-3	-4	-5	-6	-7	-8	-9	Temperature (°C)
-270	-6258										-270
-260	-6232	-6236	-6239	-6242	-6245	-6248	-6251	-6253	-6255	-6256	-260
-250	-6180	-6187	-6193	-6198	-6204	-6209	-6214	-6219	-6223	-6228	-250
-240	-6105	-6114	-6122	-6130	-6138	-6146	-6153	-6160	-6167	-6174	-240
-230	-6007	-6017	-6028	-6038	-6049	-6059	-6068	-6078	-6087	-6096	-230
-220	-5888	-5901	-5914	-5926	-5938	-5950	-5962	-5973	-5985	-5996	-220
-210	-5753	-5767	-5782	-5795	-5809	-5823	-5836	-5850	-5863	-5876	-210
-200	-5603	-5619	-5634	-5650	-5665	-5680	-5695	-5710	-5724	-5739	-200
-190	-5439	-5456	-5473	-5489	-5506	-5523	-5539	-5555	-5571	-5587	-190
-180	-5261	-5279	-5297	-5316	-5334	-5351	-5369	-5387	-5404	-5421	-180
-170	-5070	-5089	-5109	-5128	-5148	-5167	-5186	-5205	-5224	-5242	-170
-160	-4865	-4886	-4907	-4928	-4949	-4969	-4989	-5010	-5030	-5050	-160
-150	-4648	-4671	-4693	-4715	-4737	-4759	-4780	-4802	-4823	-4844	-150
-140	-4419	-4443	-4466	-4489	-4512	-4535	-4558	-4581	-4604	-4626	-140
-130	-4177	-4202	-4226	-4251	-4275	-4300	-4324	-4348	-4372	-4395	-130
-120	-3923	-3949	-3975	-4000	-4026	-4052	-4077	-4102	-4127	-4152	-120
-110	-3657	-3684	-3711	-3738	-3765	-3791	-3818	-3844	-3871	-3897	-110
-100	-3379	-3407	-3435	-3463	-3491	-3519	-3547	-3574	-3602	-3629	-100
-90	-3089	-3118	-3148	-3177	-3206	-3235	-3264	-3293	-3322	-3350	-90
-80	-2788	-2818	-2849	-2879	-2910	-2940	-2970	-3000	-3030	-3059	-80
-70	-2476	-2507	-2539	-2571	-2602	-2633	-2664	-2695	-2726	-2757	-70
-60	-2153	-2186	-2218	-2251	-2283	-2316	-2348	-2380	-2412	-2444	-60
-50	-1819	-1853	-1887	-1920	-1954	-1987	-2021	-2054	-2087	-2120	-50
-40	-1475	-1510	-1545	-1579	-1614	-1648	-1683	-1717	-1751	-1785	-40
-30	-1121	-1157	-1192	-1228	-1264	-1299	-1335	-1370	-1405	-1440	-30
-20	-757	-794	-830	-867	-904	-940	-976	-1013	-1049	-1085	-20
-10	-383	-421	-459	-496	-534	-571	-608	-646	-683	-720	-10
0	0	-39	-77	-116	-154	-193	-231	-269	-307	-345	0
Temperature (°C)	0	1	2	3	4	5	6	7	8	9	Temperature (°C)
0	0	39	78	117	156	195	234	273	312	352	0
10	391	431	470	510	549	589	629	669	709	749	10
20	790	830	870	911	951	992	1033	1074	1114	1155	20
30	1196	1238	1279	1320	1362	1403	1445	1486	1528	1570	30
40	1612	1654	1696	1738	1780	1823	1865	1908	1950	1993	40
50	2036	2079	2122	2165	2208	2251	2294	2338	2381	2425	50
60	2468	2512	2556	2600	2643	2687	2732	2776	2820	2864	60
70	2909	2953	2998	3043	3087	3132	3177	3222	3267	3312	70
80	3358	3403	3448	3494	3539	3585	3631	3677	3722	3768	80
90	3814	3860	3907	3953	3999	4046	4092	4138	4185	4232	90
100	4279	4325	4372	4419	4466	4513	4561	4608	4655	4702	100
110	4750	4798	4845	4893	4941	4988	5036	5084	5132	5180	110
120	5228	5277	5325	5373	5422	5470	5519	5567	5616	5665	120
130	5714	5763	5812	5861	5910	5959	6008	6057	6107	6156	130
140	6206	6255	6305	6355	6404	6454	6504	6554	6604	6654	140
150	6704	6754	6805	6855	6905	6956	7006	7057	7107	7158	150
160	7209	7260	7310	7361	7412	7463	7515	7566	7617	7668	160
170	7720	7771	7823	7874	7926	7977	8029	8081	8133	8185	170
180	8237	8289	8341	8393	8445	8497	8550	8602	8654	8707	180
190	8759	8812	8865	8917	8970	9023	9076	9129	9182	9235	190

Type T

JIS C 1602-1995 (Conform to IEC 584-1(1977), IEC 584-2(1982))

Unit μV

Temperature (°C)	0	1	2	3	4	5	6	7	8	9	Temperature (°C)
200	9288	9341	9395	9448	9501	9555	9608	9662	9715	9769	200
210	9822	9876	9930	9984	10038	10092	10146	10200	10254	10308	210
220	10362	10417	10471	10525	10580	10634	10689	10743	10798	10853	220
230	10907	10962	11017	11072	11127	11182	11237	11292	11347	11403	230
240	11458	11513	11569	11624	11680	11735	11791	11846	11902	11958	240
250	12013	12069	12125	12181	12237	12293	12349	12405	12461	12518	250
260	12574	12630	12687	12743	12799	12856	12912	12969	13026	13082	260
270	13139	13196	13253	13310	13366	13423	13480	13537	13595	13652	270
280	13709	13766	13823	13881	13938	13995	14053	14110	14168	14226	280
290	14283	14341	14399	14456	14514	14572	14630	14688	14746	14804	290
300	14862	14920	14978	15036	15095	15153	15211	15270	15328	15386	300
310	15445	15503	15562	15621	15679	15738	15797	15856	15914	15973	310
320	16032	16091	16150	16209	16268	16327	16387	16446	16505	16564	320
330	16624	16683	16742	16802	16861	16921	16980	17040	17100	17159	330
340	17219	17279	17339	17399	17458	17518	17578	17638	17698	17759	340
350	17819	17879	17939	17999	18060	18120	18180	18241	18301	18362	350
360	18422	18483	18543	18604	18665	18725	18786	18847	18908	18969	360
370	19030	19091	19152	19213	19274	19335	19396	19457	19518	19579	370
380	19641	19702	19763	19825	19886	19947	20009	20070	20132	20193	380
390	20255	20317	20378	20440	20502	20563	20625	20687	20748	20810	390
400	20872										400

REMARK

Standard contact temperature is 0 °C.

Appendix 3.8 Standard Thermal Electromotive Force of N

Type N
Unit μV

JIS C 1602-1995 (Conform to IEC 584-1(1977), IEC 584-2(1982))

Temperature (°C)	0	-1	-2	-3	-4	-5	-6	-7	-8	-9	Temperature (°C)
-270	-4345										-270
-260	-4336	-4337	-4339	-4340	-4341	-4342	-4343	-4344	-4344	-4345	-260
-250	-4313	-4316	-4319	-4321	-4324	-4326	-4328	-4330	-4332	-4334	-250
-240	-4277	-4281	-4285	-4289	-4293	-4297	-4300	-4304	-4307	-4310	-240
-230	-4226	-4232	-4238	-4243	-4248	-4254	-4258	-4263	-4268	-4273	-230
-220	-4162	-4169	-4176	-4183	-4189	-4196	-4202	-4209	-4215	-4221	-220
-210	-4083	-4091	-4100	-4108	-4116	-4124	-4132	-4140	-4147	-4154	-210
-200	-3990	-4000	-4010	-4020	-4029	-4038	-4048	-4057	-4066	-4074	-200
-190	-3884	-3896	-3907	-3918	-3928	-3939	-3950	-3960	-3970	-3980	-190
-180	-3766	-3778	-3790	-3803	-3815	-3827	-3838	-3850	-3862	-3873	-180
-170	-3634	-3648	-3662	-3675	-3688	-3702	-3715	-3728	-3740	-3753	-170
-160	-3491	-3506	-3521	-3535	-3550	-3564	-3578	-3593	-3607	-3621	-160
-150	-3336	-3352	-3368	-3384	-3400	-3415	-3431	-3446	-3461	-3476	-150
-140	-3171	-3188	-3205	-3221	-3238	-3255	-3271	-3288	-3304	-3320	-140
-130	-2994	-3012	-3030	-3048	-3066	-3084	-3101	-3119	-3136	-3153	-130
-120	-2808	-2827	-2846	-2865	-2883	-2902	-2921	-2939	-2958	-2976	-120
-110	-2612	-2632	-2652	-2672	-2691	-2711	-2730	-2750	-2769	-2789	-110
-100	-2407	-2428	-2448	-2469	-2490	-2510	-2531	-2551	-2571	-2592	-100
-90	-2193	-2215	-2237	-2258	-2280	-2301	-2322	-2344	-2365	-2386	-90
-80	-1972	-1995	-2017	-2039	-2062	-2084	-2106	-2128	-2150	-2172	-80
-70	-1744	-1767	-1790	-1813	-1836	-1859	-1882	-1905	-1927	-1950	-70
-60	-1509	-1533	-1557	-1580	-1604	-1627	-1651	-1674	-1698	-1721	-60
-50	-1269	-1293	-1317	-1341	-1366	-1390	-1414	-1438	-1462	-1485	-50
-40	-1023	-1048	-1072	-1097	-1122	-1146	-1171	-1195	-1220	-1244	-40
-30	-772	-798	-823	-848	-873	-898	-923	-948	-973	-998	-30
-20	-518	-569	-569	-595	-620	-646	-671	-696	-722	-747	-20
-10	-260	-286	-312	-338	-364	-390	-415	-441	-467	-492	-10
0	0	-26	-52	-78	-104	-131	-157	-183	-209	-234	0
Temperature (°C)	0	1	2	3	4	5	6	7	8	9	Temperature (°C)
0	0	26	52	78	104	130	156	182	208	235	0
10	261	287	313	340	366	393	419	446	472	499	10
20	525	552	578	605	632	659	685	712	739	766	20
30	793	820	847	874	901	928	955	983	1010	1037	30
40	1065	1092	1119	1147	1174	1202	1229	1257	1284	1312	40
50	1340	1368	1395	1423	1451	1479	1507	1535	1563	1591	50
60	1619	1647	1675	1703	1732	1760	1788	1817	1845	1873	60
70	1902	1930	1959	1988	2016	2045	2074	2102	2131	2160	70
80	2189	2218	2247	2276	2305	2334	2363	2392	2421	2450	80
90	2480	2509	2538	2568	2597	2626	2656	2685	2715	2744	90
100	2774	2804	2833	2863	2893	2923	2953	2983	3012	3042	100
110	3072	3102	3133	3163	3193	3223	3253	3283	3314	3344	110
120	3374	3405	3435	3466	3496	3527	3557	3588	3619	3649	120
130	3680	3711	3742	3772	3803	3834	3865	3896	3927	3958	130
140	3989	4020	4051	4083	4114	4145	4176	4208	4239	4270	140
150	4302	4333	4365	4396	4428	4459	4491	4523	4554	4586	150
160	4618	4650	4681	4713	4745	4777	4809	4841	4873	4905	160
170	4937	4969	5001	5033	5066	5098	5130	5162	5195	5227	170
180	5259	5292	5324	5357	5389	5422	5454	5487	5520	5552	180

Type N

JIS C 1602-1995 (Conform to IEC 584-1(1977), IEC 584-2(1982))

Unit μV

Temperature (°C)	0	1	2	3	4	5	6	7	8	9	Temperature (°C)
190	5585	5618	5650	5683	5716	5749	5782	5815	5847	5880	190
200	5913	5946	5979	6013	6046	6079	6112	6145	6178	6211	200
210	6245	6278	6311	6345	6378	6411	6445	6478	6512	6545	210
220	6579	6612	6646	6680	6713	6747	6781	6814	6848	6882	220
230	6916	6949	6983	7017	7051	7085	7119	7153	7187	7221	230
240	7255	7289	7323	7357	7392	7426	7460	7494	7528	7563	240
250	7597	7631	7666	7700	7734	7769	7803	7838	7872	7907	250
260	7941	7976	8010	8045	8080	8114	8149	8184	8218	8253	260
270	8288	8323	8358	8392	8427	8462	8497	8532	8567	8602	270
280	8637	8672	8707	8742	8777	8812	8847	8882	8918	8953	280
290	8988	9023	9058	9094	9129	9164	9200	9235	9270	9306	290
300	9341	9377	9412	9448	9483	9519	9554	9590	9625	9661	300
310	9696	9732	9768	9803	9839	9875	9910	9946	9982	10018	310
320	10054	10089	10125	10161	10197	10233	10269	10305	10341	10377	320
330	10413	10449	10485	10521	10557	10593	10629	10665	10701	10737	330
340	10774	10810	10846	10882	10918	10955	10991	11027	11064	11100	340
350	11136	11173	11209	11245	11282	11318	11355	11391	11428	11464	350
360	11501	11537	11574	11610	11647	11683	11720	11757	11793	11830	360
370	11867	11903	11940	11977	12013	12050	12087	12124	12160	12197	370
380	12234	12271	12308	12345	12382	12418	12455	12492	12529	12566	380
390	12603	12640	12677	12714	12751	12788	12825	12862	12899	12937	390
400	12974	13011	13048	13085	13122	13159	13197	13234	13271	13308	400
410	13346	13383	13420	13457	13495	13532	13569	13607	13644	13682	410
420	13719	13756	13794	13831	13869	13906	13944	13981	14019	14056	420
430	14094	14131	14169	14206	14244	14281	14319	14356	14394	14432	430
440	14469	14507	14545	14582	14620	14658	14695	14733	14771	14809	440
450	14846	14884	14922	14960	14998	15035	15073	15111	15149	15187	450
460	15225	15262	15300	15338	15376	15414	15452	15490	15528	15566	460
470	15604	15642	15680	15718	15756	15794	15832	15870	15908	15946	470
480	15984	16022	16060	16099	16137	16175	16213	16251	16289	16327	480
490	16366	16404	16442	16480	16518	16557	16595	16633	16671	16710	490
500	16748	16786	16824	16863	16901	16939	16978	17016	17054	17093	500
510	17131	17169	17208	17246	17285	17323	17361	17400	17438	17477	510
520	17515	17554	17592	17630	17669	17707	17746	17784	17823	17861	520
530	17900	17938	17977	18016	18054	18093	18131	18170	18208	18247	530
540	18286	18324	18363	18401	18440	18479	18517	18556	18595	18633	540
550	18672	18711	18749	18788	18827	18865	18904	18943	18982	19020	550
560	19059	19098	19136	19175	19214	19253	19292	19330	19369	19408	560
570	19447	19485	19524	19563	19602	19641	19680	19718	19757	19796	570
580	19835	19874	19913	19952	19990	20029	20068	20107	20146	20185	580
590	20224	20263	20302	20341	20379	20418	20457	20496	20535	20574	590
600	20613	20652	20691	20730	20769	20808	20847	20886	20925	20964	600
610	21003	21042	21081	21120	21159	21198	21237	21276	21315	21354	610
620	21393	21432	21471	21510	21549	21588	21628	21667	21706	21745	620
630	21784	21823	21862	21901	21940	21979	22018	22058	22097	22136	630
640	22175	22214	22253	22292	22331	22370	22410	22449	22488	22527	640
650	22566	22605	22644	22684	22723	22762	22801	22840	22879	22919	650
660	22958	22997	23036	23075	23115	23154	23193	23232	23271	23311	660
670	23350	23389	23428	23467	23507	23546	23585	23624	23663	23703	670
680	23742	23781	23820	23860	23899	23938	23977	24016	24056	24095	680
690	24134	24173	24213	24252	24291	24330	24370	24409	24448	24487	690

Type N

JIS C 1602-1995 (Conform to IEC 584-1(1977), IEC 584-2(1982))

Unit μV

Temperature (°C)	0	1	2	3	4	5	6	7	8	9	Temperature (°C)
700	24527	24566	24605	24644	24684	24723	24762	24801	24841	24880	700
710	24919	24959	24998	25037	25076	25116	25155	25194	25233	25273	710
720	25312	25351	25391	25430	25469	25508	25548	25587	25626	25666	720
730	25705	25744	25783	25823	25862	25901	25941	25980	26019	26058	730
740	26098	26137	26176	26216	26255	26294	26333	26373	26412	26451	740
750	26491	26530	26569	26608	26648	26687	26726	26766	26805	26844	750
760	26883	26923	26962	27001	27041	27080	27119	27158	27198	27237	760
770	27276	27316	27355	27394	27433	27473	27512	27551	27591	27630	770
780	27669	27708	27748	27787	27826	27866	27905	27944	27983	28023	780
790	28062	28101	28140	28180	28219	28258	28297	28337	28376	28415	790
800	28455	28494	28533	28572	28612	28651	28690	28729	28769	28808	800
810	28847	28886	28926	28965	29004	29043	29083	29122	29161	29200	810
820	29239	29279	29318	29357	29396	29436	29475	29514	29553	29592	820
830	29632	29671	29710	29749	29789	29828	29867	29906	29945	29985	830
840	30024	30063	30102	30141	30181	30220	30259	30298	30337	30376	840
850	30416	30455	30494	30533	30572	30611	30651	30690	30729	30768	850
860	30807	30846	30886	30925	30964	31003	31042	31081	31120	31160	860
870	31199	31238	31277	31316	31355	31394	31433	31473	31512	31551	870
880	31590	31629	31668	31707	31746	31785	31824	31863	31903	31942	880
890	31981	32020	32059	32098	32137	32176	32215	32254	32293	32332	890
900	32371	32410	32449	32488	32527	32566	32605	32644	32683	32722	900
910	32761	32800	32839	32878	32917	32956	32995	33034	33073	33112	910
920	33151	33190	33229	33268	33307	33346	33385	33424	33463	33502	920
930	33541	33580	33619	33658	33697	33736	33774	33813	33852	33891	930
940	33930	33969	34008	34047	34086	34124	34163	34202	34241	34280	940
950	34319	34358	34396	34435	34474	34513	34552	34591	34629	34668	950
960	34707	34746	34785	34823	34862	34901	34940	34979	35017	35056	960
970	35095	35134	35172	35211	35250	35289	35327	35366	35405	35444	970
980	35482	35521	35560	35598	35637	35676	35714	35753	35792	35831	980
990	35869	35908	35946	35985	36024	36062	36101	36140	36178	36217	990
1000	36256	36294	36333	36371	36410	36449	36487	36526	36564	36603	1000
1010	36641	36680	36718	36757	36796	36834	36873	36911	36950	36988	1010
1020	37027	37065	37104	37142	37181	37219	37258	37296	37334	37373	1020
1030	37411	37450	37488	37527	37565	37603	37642	37680	37719	37757	1030
1040	37795	37834	37872	37911	37949	37987	38026	38064	38102	38141	1040
1050	38179	38217	38256	38294	38332	38370	38409	38447	38485	38524	1050
1060	38562	38600	38638	38677	38715	38753	38791	38829	38868	38906	1060
1070	38944	38982	39020	39059	39097	39135	39173	39211	39249	39287	1070
1080	39326	39364	39405	39440	39478	39516	39554	39592	39630	39668	1080
1090	39706	39744	39783	39821	39859	39897	39935	39973	40011	40049	1090
1100	40087	40125	40163	40201	40238	40276	40314	40352	40390	40428	1100
1110	40466	40504	40542	40580	40618	40655	40693	40731	40769	40807	1110
1120	40845	40883	40920	40958	40996	41034	41072	41109	41147	41185	1120
1130	41223	41260	41298	41336	41374	41411	41449	41487	41525	41562	1130
1140	41600	41638	41675	41713	41751	41788	41826	41864	41901	41939	1140
1150	41976	42014	42052	42089	42127	42164	42202	42239	42277	42314	1150
1160	42352	42390	42427	42465	42502	42540	42577	42614	42652	42689	1160
1170	42727	42764	42802	42839	42877	42914	42951	42989	43026	43064	1170
1180	43101	43138	43176	43213	43250	43288	43325	43362	43399	43437	1180
1190	43474	43511	43549	43586	43623	43660	43698	43735	43772	43809	1190

Type N

JIS C 1602-1995 (Conform to IEC 584-1(1977), IEC 584-2(1982))

Unit μV

Temperature (°C)	0	1	2	3	4	5	6	7	8	9	Temperature (°C)
1200	43846	43884	43921	43958	43995	44032	44069	44106	44144	44181	1200
1210	44218	44255	44292	44329	44366	44403	44440	44477	44514	44551	1210
1220	44588	44625	44662	44699	44736	44773	44810	44847	44884	44921	1220
1230	44958	44995	45032	45069	45105	45142	45179	45216	45253	45290	1230
1240	45326	45363	45400	45437	45474	45510	45547	45584	45621	45657	1240
1250	45694	45731	45767	45804	45841	45877	45914	45951	45987	46024	1250
1260	46060	46097	46133	46170	46207	46243	46280	46316	46353	46389	1260
1270	46425	46462	46498	46535	46571	46608	46644	46680	46717	46753	1270
1280	46789	46826	46862	46898	46935	46971	47007	47043	47079	47116	1280
1290	47152	47188	47224	47260	47296	47333	47369	47405	47441	47477	1290
1300	47513										1300

REMARK

Standard contact temperature is 0 °C.

Appendix 4 Upgrading of Q64TD/Q64TDV-GH Functions

The Q64TD of function version C has new functions that the conventional product (function version B) does not have.

The Q64TDV-GH does not have a product of function version B.

Appendix 4.1 Comparison between Q64TD and Q64TDV-GH Functions

The following functions are supported by function version C.

Function	Function version B	Function version C (First 5 digits of product information are 07071 or earlier)	Function version C (First 5 digits of product information are 07072 or later)
Online module change	×	○	○
Dedicated instruction (G(P).OFFGAN/G(P).OGLOAD/ G(P).OGSTOR)	×	○	○
Mode switching that does not require programmable controller CPU to be reset	—	—	—
Dedicated instruction (G(P).OFFGAN)	×	○	○
Buffer memory (mode switching setting) and operating condition setting request (Y9)	×	○	○
GX Configurator-TI	×	○	○
Conversion setting for disconnection detection function	×	×	○

○ : Compatible × : Not compatible

Appendix 4.2 When the Q64TD/Q64TDV-GH has Product Information which First 5 Digits are 07071 or Earlier

The following shows differences between the Q64TD/Q64TDV-GH whose first 5 digits of product information are 07071 or earlier and those of 07072 or later.

Item	Q64TD/Q64TDV-GH	
	First 5 digits of product information are 07071 or earlier	First 5 digits of product information are 07072 or later
Conversion setting for disconnection detection function	No conversion setting for disconnection detection function	For values to be stored in the CH□ measured temperature value/micro voltage value (buffer memory addresses 11 to 14: Un\G11 to 14) in the case of disconnection detection, any of "Value immediately before disconnection", "Up scale (maximum value of measured temperature range + 5% of measured temperature range)", "Down scale (minimum value of measured temperature range – 5% of measured temperature range)" or "Given value" can be selected.
Conversion completion flag (XE)	The Conversion completion flag (XE) turns OFF when disconnection is detected, and a value immediately before the detection is held in the CH□ measured temperature value/micro voltage value (Un\G11 to 14).	When disconnection is detected, the Conversion completion flag (XE) does not turn OFF and a value based on the Conversion setting for disconnection detection (Un\G148) is stored in the CH□ measured temperature value/micro voltage value (Un\G11 to 14).
	The Conversion completion flag (XE) turns OFF when disconnection is detected. Upon recovery of the connection, the temperature conversion value/micro voltage conversion value update is restarted independently of the Disconnection detection flag (XC) reset. After the initial update, the Conversion completion flag (XE) turns ON again.	When disconnection is detected, the Conversion completion flag (XE) does not turn OFF. Upon recovery of the connection, the temperature conversion value update is restarted independently of the Disconnection detection flag (XC) reset.
Conversion completion flag (Un\G10)	When disconnection is detected, the Conversion completion flag (Un\G10) for the channel disconnected turns OFF (0).	When disconnection is detected, the Conversion completion flag (Un\G10) for the channel disconnected does not turn OFF (0).
Conversion setting for disconnection detection (Un\G148)	The Conversion setting for disconnection detection (Un\G148) is not provided.	For values to be stored in the CH□ measured temperature value/micro voltage value (buffer memory addresses 11 to 14: Un\G11 to 14) in the case of disconnection detection, any of "Value immediately before disconnection", "Up scale (maximum value of measured temperature range + 5% of measured temperature range)", "Down scale (minimum value of measured temperature range – 5% of measured temperature range)" or "Given value" can be selected. (see Section 3.4.20)
CH□ Conversion setting value for disconnection detection (Un\G150 to 153)	The Conversion setting value for disconnection detection (Un\G150 to 153) is not provided.	If Given value (3H) is set in the Conversion setting for disconnection detection (Un\G148), when disconnection is detected, the value set in this area is stored in the CH□ measured temperature value/micro voltage value (Un\G11 to 14). (see Section 3.4.21)

Appendix 5 Dedicated Instruction

Appendix 5.1 Dedicated Instruction List and Available Device

(1) Dedicated instruction list

The following table lists the dedicated instructions that can be used with the Q64TD/Q64TDV-GH converter modules.

Instruction	Description	Reference section
G(P).OFFGAN	Switches to the offset/gain setting mode. Switches to the normal mode.	Appendix 5.2
G(P).OGLOAD	Reads the offset/gain values of the user range setting to the CPU.	Appendix 5.3
G(P).OGSTOR	Restores the offset/gain values of the user range setting stored in the CPU to the Q64TD/Q64TDV-GH converter module.	Appendix 5.4

POINT

When the module is mounted to a MELSECNET/H remote station, the dedicated instructions cannot be used.

(2) Available devices

The following devices are available for the dedicated instructions:

Internal devices		File register	Constant
Bit ^{*1}	Word		
X, Y, M, L, F, V, B	T, ST, C, D, W	R, ZR	—

*1: Word device bit designation can be used as bit data.

Word device bit designation is done by designating **[Word device]** . **[Bit No.]** .

(Designation of bit numbers is done in hexadecimal.)

For example, bit 10 of D0 is designated as **[D0.A]** .

However, there can be no bit designation for timers (T), retentive timers (ST) and counters (C).

Appendix 5.2 G(P).OFFGAN

Switches the mode of the Q64TD/Q64TDV-GH converter module. (Normal mode to offset/gain setting mode, offset/gain setting mode to normal mode)

Set data	Usable devices									
	Internal device (System, user)		File register	Link direct device J□\□		Intelligent function module device U□\G□	Index register Z□	Constant		Other
	Bit	Word		Bit	Word			K, H	\$	
(S)	—	○						—	—	—

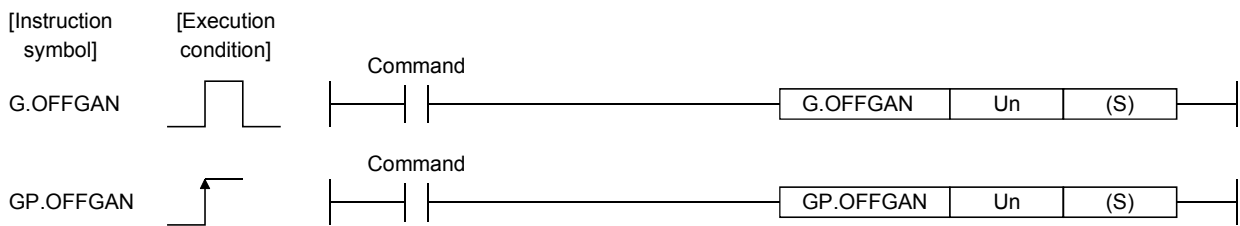

Set data

Device	Description	Setting range	Data type
Un	Start I/O number of the module	0 to FEH	Binary 16 bits
(S)	Mode switching 0: Switching to normal mode 1: Switching to offset/gain setting mode The setting of any other value results in "switching to offset/gain setting mode".	0, 1	Binary 16 bits

(1) Function

Switches the mode of the Q64TD/Q64TDV-GH converter module.

- Normal mode to offset/gain setting mode
- Offset/gain setting mode to normal mode

POINT

- (1) When the offset/gain setting mode is switched to the normal mode, Module Ready (X0) turns from OFF to ON.
Note that initial setting processing will be executed if there is a sequence program that makes initial setting when Module Ready (X0) turns ON.
- (2) For the Q64TD only, an error is cleared when mode switching is performed.

(2) Operation error

No errors.

(3) Program example

The following program is designed to switch the Q64TD/Q64TDV-GH converter module mounted in the position of I/O number X/Y0 to X/YF to the offset/gain setting mode when M10 is turned ON, and to return it to the normal mode when M10 is turned OFF.

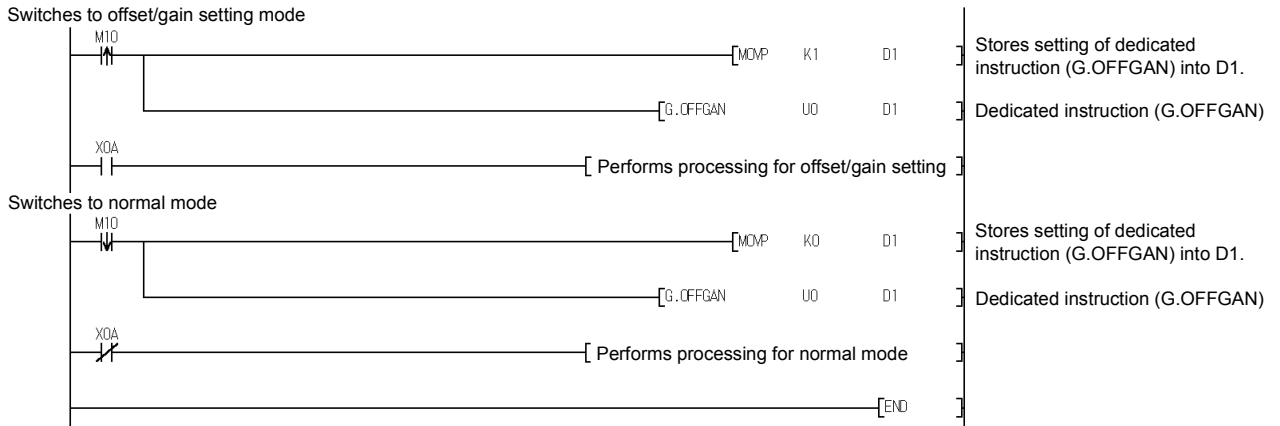

Appendix 5.3 G(P).OGLOAD

Reads the offset/gain values of the user range setting of the Q64TD/Q64TDV-GH converter module to the CPU.

Set data	Usable devices									
	Internal device (System, user)		File register	Link direct device J□\□		Intelligent function module device U□\G□	Index register Z□	Constant		Other
	Bit	Word		Bit	Word			K, H	\$	
(S)	—	○			—			—	—	—
(D)		○			—			—	—	—

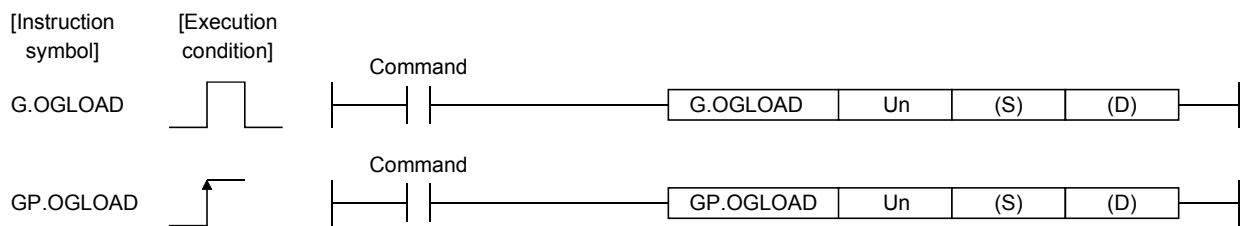

Set data

Device	Description	Setting range	Data type
Un	Start I/O number of the module	0 to FEH	Binary 16 bits
(S)	Start number of the device in which control data is stored.	Within the range of the specified device	Device name
(D)	Device that is turned ON 1 scan on completion of dedicated instruction processing. (D) + 1 also turns ON at an abnormal completion.	Within the range of the specified device	Bit

Control data *1

Device	Item	Set data	Setting range	Set by
(S)	System area	—	—	—
(S) + 1	Completion status	Stores the status when the instruction is complete. 0 : Normal completion Other than 0: Abnormal completion	—	System
(S) + 2	System area	—	—	—
(S) + 3				
(S) + 4	CH1 Factory default offset value	—	—	System
(S) + 5	CH1 Factory default gain value	—	—	System
(S) + 6	CH1 User range settings offset value	—	—	System
(S) + 7	CH1 User range settings gain value	—	—	System
(S) + 8	CH1 User range settings thermal EMF offset value (L)	—	—	System
(S) + 9	(H)	—	—	System
(S) + 10	CH1 User range settings thermal EMF gain value (L)	—	—	System
(S) + 11	(H)	—	—	System
(S) + 12	CH2 Factory default offset value	—	—	System
(S) + 13	CH2 Factory default gain value	—	—	System
(S) + 14	CH2 User range settings offset value	—	—	System
(S) + 15	CH2 User range settings gain value	—	—	System
(S) + 16	CH2 User range settings thermal EMF offset value (L)	—	—	System
(S) + 17	(H)	—	—	System
(S) + 18	CH2 User range settings thermal EMF gain value (L)	—	—	System
(S) + 19	(H)	—	—	System
(S) + 20	CH3 Factory default offset value	—	—	System
(S) + 21	CH3 Factory default gain value	—	—	System
(S) + 22	CH3 User range settings offset value	—	—	System
(S) + 23	CH3 User range settings gain value	—	—	System
(S) + 24	CH3 User range settings thermal EMF offset value (L)	—	—	System
(S) + 25	(H)	—	—	System
(S) + 26	CH3 User range settings thermal EMF gain value (L)	—	—	System
(S) + 27	(H)	—	—	System
(S) + 28	CH4 Factory default offset value	—	—	System
(S) + 29	CH4 Factory default gain value	—	—	System
(S) + 30	CH4 User range settings offset value	—	—	System
(S) + 31	CH4 User range settings gain value	—	—	System
(S) + 32	CH4 User range settings thermal EMF offset value (L)	—	—	System
(S) + 33	(H)	—	—	System
(S) + 34	CH4 User range settings thermal EMF gain value (L)	—	—	System
(S) + 35	(H)	—	—	System

*1 Setting is not necessary. If setting is made, the offset/gain values will not be read properly.

(1) Functions

- (a) Reads the offset/gain values of the user range setting of the Q64TD/Q64TDV-GH converter module to the CPU.
- (b) There are two types of interlock signals for the G(P).OGLOAD instruction: the completion device (D) and the status display device at completion (D) + 1.
 - 1) Completion device
Turns ON in the END processing of the scan where the G(P).OGLOAD instruction is completed, and turns OFF in the next END processing.
 - 2) Status display device at completion
Turns ON and OFF depending on the completion status of the G(P).OGLOAD instruction.
Normal completion : Stays OFF and does not change.
Abnormal completion: Turns ON in the END processing of the scan where the G(P).OGLOAD instruction is completed, and turns OFF in the next END processing.

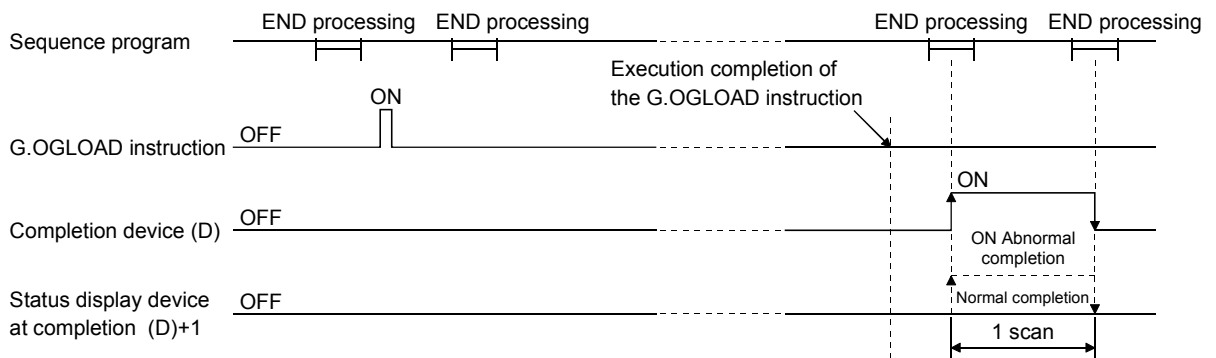

(2) Operation error

No errors.

(3) Program example

The following program is designed to read the offset/gain values of the Q64TD/Q64TDV-GH converter module mounted in the position of I/O number X/Y0 to X/YF when M11 is turned ON.

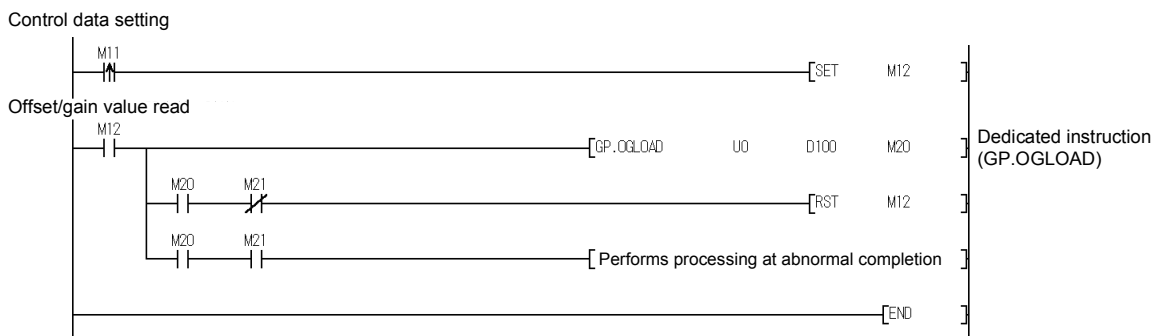

Appendix 5.4 G(P).OGSTOR

Restores the offset/gain values of the user range setting stored in the CPU to the Q64TD/Q64TDV-GH converter module.

Set data	Usable devices									
	Internal device (System, user)		File register	Link direct device J□\□		Intelligent function module device U□\G□	Index register Z□	Constant		Other
	Bit	Word		Bit	Word			K, H	\$	
(S)	—	○			—			—	—	—
(D)		○			—			—	—	—

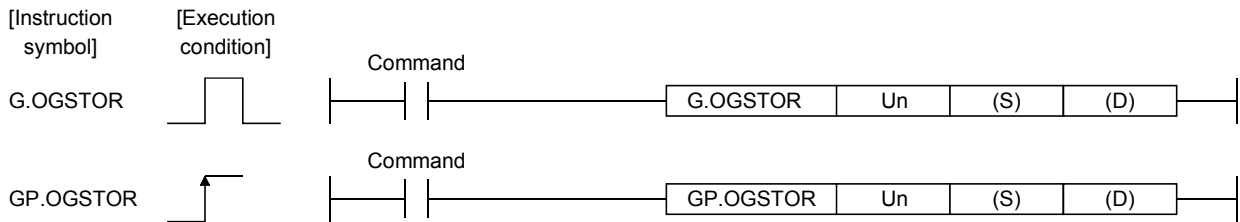

Set data

Device	Description	Setting range	Data type
Un	Start I/O number of the module	0 to FEH	Binary 16 bits
(S) * 1	Start number of the device in which control data is stored.	Within the range of the specified device	Device name
(D)	Device that is turned ON 1 scan on completion of dedicated instruction processing. (D) + 1 also turns ON at an abnormal completion.	Within the range of the specified device	Bit

*1 When executing the G.OGLOAD instruction, specify the device designated in (S).
Do not change the data read with the G.OGLOAD instruction.
If it is changed, normal operation cannot be guaranteed.

Control data

Device	Item	Set data	Setting range	Set by
(S)	System area	—	—	—
(S) + 1	Completion status	Stores the status when the instruction is complete. 0 : Normal completion Other than 0: Abnormal completion	—	System
(S) + 2	System area	—	—	—
(S) + 3				
(S) + 4	CH1 Factory default offset value	—	—	System
(S) + 5	CH1 Factory default gain value	—	—	System
(S) + 6	CH1 User range settings offset value	—	—	System
(S) + 7	CH1 User range settings gain value	—	—	System
(S) + 8	CH1 User range settings thermal EMF	—	—	System
(S) + 9	offset value (L) (H)	—	—	System
(S) + 10	CH1 User range settings thermal EMF	—	—	System
(S) + 11	gain value (L) (H)	—	—	System
(S) + 12	CH2 Factory default offset value	—	—	System
(S) + 13	CH2 Factory default gain value	—	—	System
(S) + 14	CH2 User range settings offset value	—	—	System
(S) + 15	CH2 User range settings gain value	—	—	System
(S) + 16	CH2 User range settings thermal EMF	—	—	System
(S) + 17	offset value (L) (H)	—	—	System
(S) + 18	CH2 User range settings thermal EMF	—	—	System
(S) + 19	gain value (L) (H)	—	—	System
(S) + 20	CH3 Factory default offset value	—	—	System
(S) + 21	CH3 Factory default gain value	—	—	System
(S) + 22	CH3 User range settings offset value	—	—	System
(S) + 23	CH3 User range settings gain value	—	—	System
(S) + 24	CH3 User range settings thermal EMF	—	—	System
(S) + 25	offset value (L) (H)	—	—	System
(S) + 26	CH3 User range settings thermal EMF	—	—	System
(S) + 27	gain value (L) (H)	—	—	System
(S) + 28	CH4 Factory default offset value	—	—	System
(S) + 29	CH4 Factory default gain value	—	—	System
(S) + 30	CH4 User range settings offset value	—	—	System
(S) + 31	CH4 User range settings gain value	—	—	System
(S) + 32	CH4 User range settings thermal EMF	—	—	System
(S) + 33	offset value (L) (H)	—	—	System
(S) + 34	CH4 User range settings thermal EMF	—	—	System
(S) + 35	gain value (L) (H)	—	—	System

(1) Functions

(a) Restores the offset/gain values of the user range setting stored in the CPU to the Q64TD/Q64TDV-GH converter module.

(b) There are two types of interlock signals for the G(P).OGSTOR instruction: the completion device (D) and the status display device at completion (D) + 1.

1) Completion device

Turns ON in the END processing of the scan where the G(P).OGSTOR instruction is completed, and turns OFF in the next END processing.

2) Status display device at completion

Turns ON and OFF depending on the completion status of the G(P).OGSTOR instruction.

Normal completion : Stays OFF and does not change.

Abnormal completion: Turns ON in the END processing of the scan where the G(P).OGSTOR instruction is completed, and turns OFF in the next END processing.

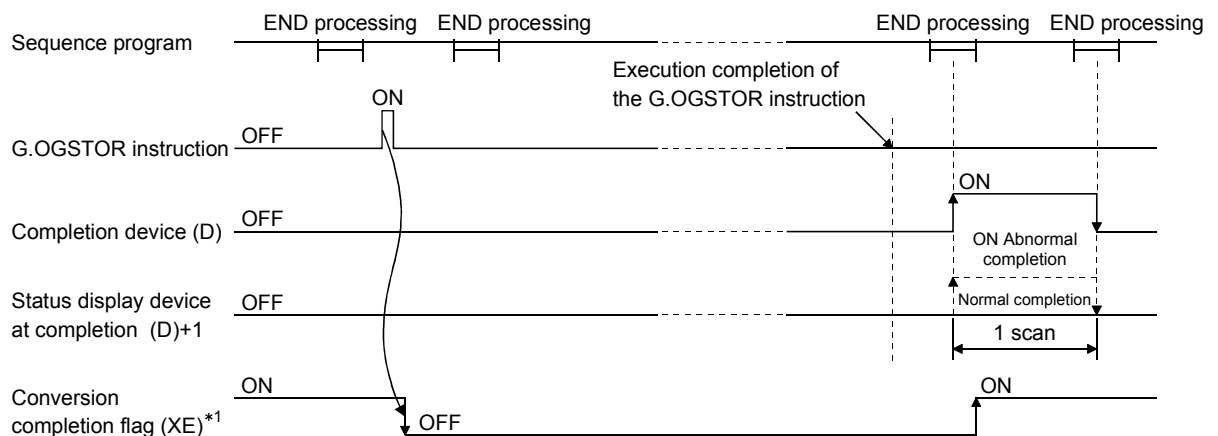

*1 When the G(P).OGSTOR instruction is executed, conversion is not performed. After the completion device (D) turns ON, conversion starts, the conversion value is stored into the buffer memory, and the conversion completion flag (XE) turns ON.

(c) When the offset/gain values are restored, the reference accuracy falls to about less than 1/3 times of the previous accuracy.

(2) Operation error

In any of the following cases, an error occurs and the corresponding error code is stored into the completion status area (S)+1.

Error code	Case resulting in operation error
161	The G(P).OGSTOR instruction was executed in the offset/gain setting mode.
162	The G(P).OGSTOR instruction was executed consecutively.
163	The G(P).OGSTOR instruction was executed for the model that differs from the model for which the G(P).OGLOAD instruction had been executed.

(3) Program example

The following program is designed to read the offset/gain values of the Q64TD/Q64TDV-GH converter module mounted in the position of I/O number X/Y0 to X/YF when M11 is turned ON.

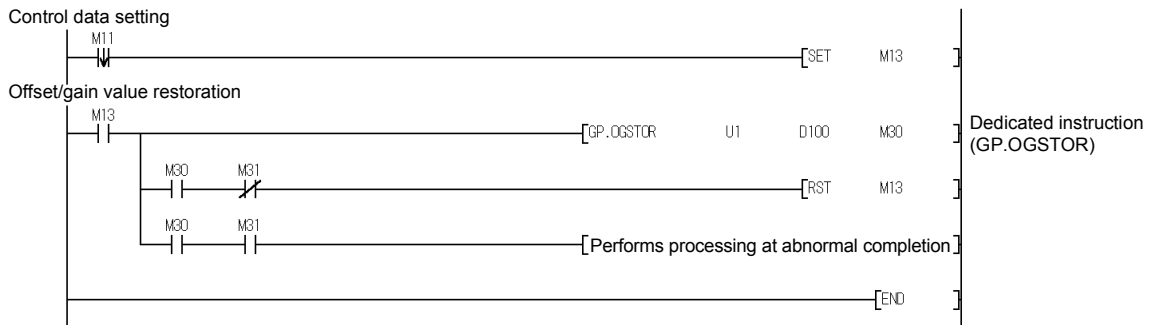

Appendix 6 Differences between Q64TD and Q64TDV-GH

The main differences between the Q64TD and Q64TDV-GH are described below.

(1) **Presence/absence of micro voltage input**

Only the Q64TDV-GH allows micro voltage input.

(2) **Accuracy**

The accuracy differs between the Q64TD and Q64TDV-GH. Refer to Section 3.1.1 and Section 3.1.2 for details.

(3) **Conversion speed**

The conversion speed differs between the Q64TD and Q64TDV-GH. Refer to Section 3.1.1 and Section 3.1.2 for details.

Appendix 7 External Dimension Diagram

(1) Q64TD

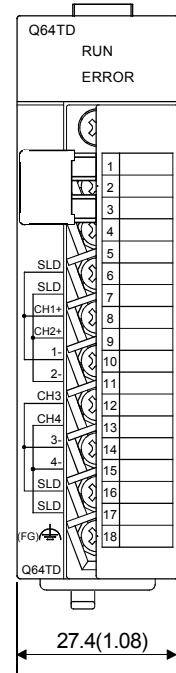
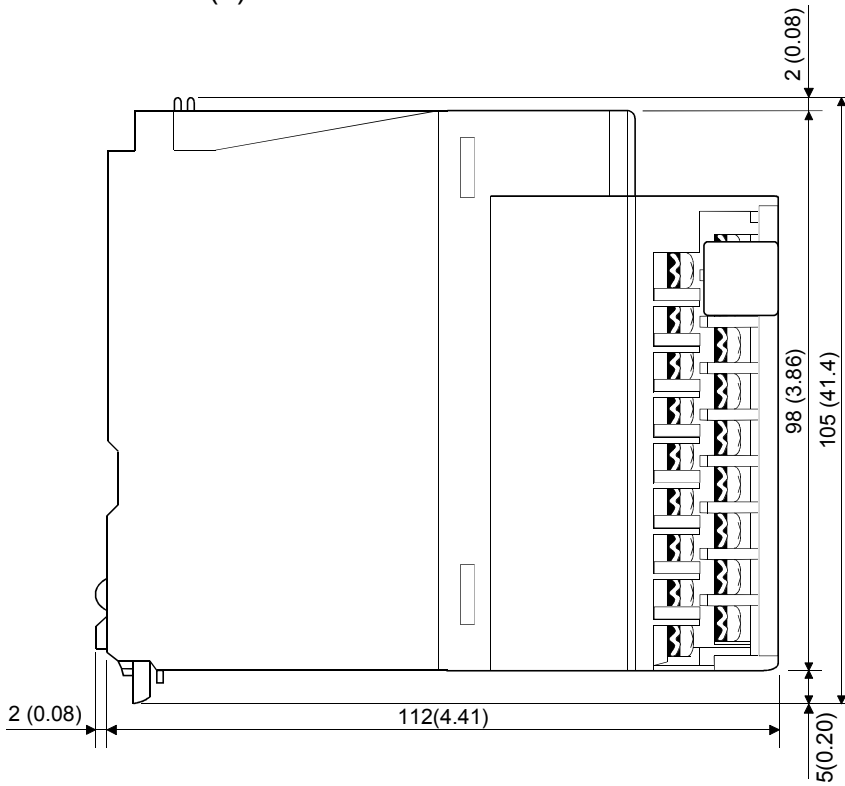

Unit : mm (in.)

(2) Q64TDV-GH

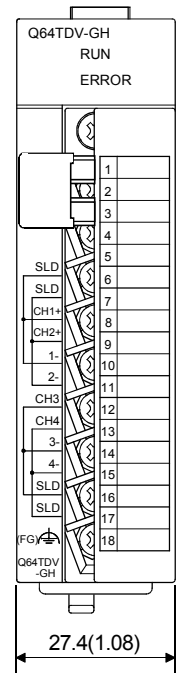
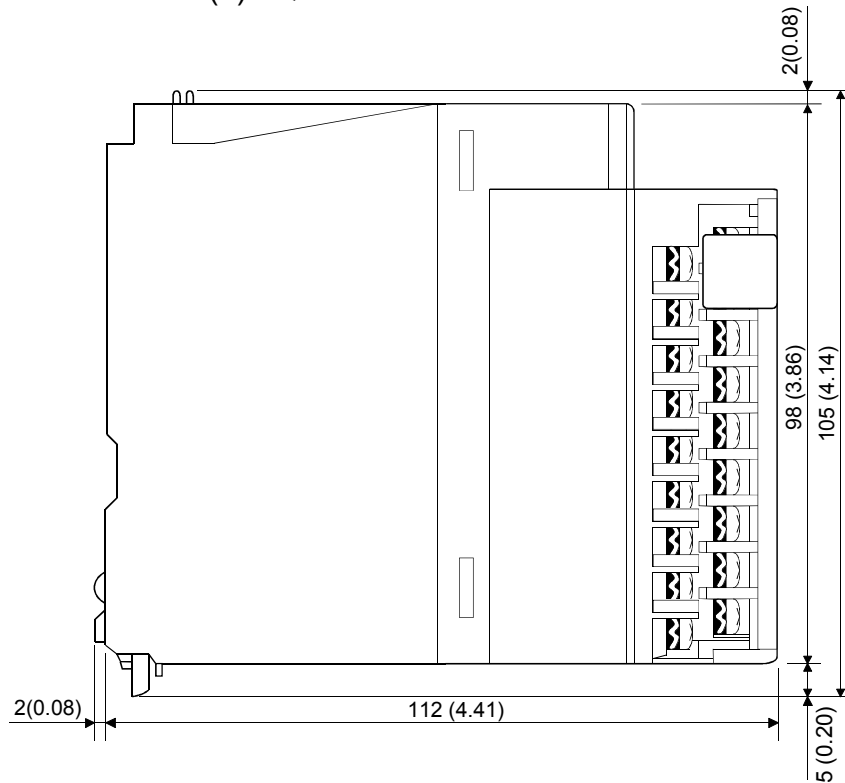

Unit : mm (in.)

INDEX

[A]
 Accuracy 3- 1, 3- 4
 Allowable temperature differencesApp.- 1
 Auto refresh settings 5- 1, 5-14
 Averaging processing..... 3- 9, 3-10
 Averaging processing specification 3-26

[B]
 Buffer memory..... 3-19, 3-22

[C]
 Cold junction temperature compensation resistor 4- 3
 Cold junction temperature compensation yes/no setting 4-13
 Conversion completion flag 3-27
 Conversion enable/disable function..... 3- 7
 Conversion enable/disable setting..... 3-25
 Conversion setting for disconnection detection 3-37
 Conversion setting for disconnection detection function 3-12
 Conversion setting value for disconnection detection 3-39

[D]
 Disconnection detection flag 3-15, 3-32
 Disconnection detection function 3- 7

[E]
 Error clear request..... 3-17
 Error code 3-29
 Error code list 8- 1
 Error flag 3-16
 ERROR LED 4-3
 External dimension diagram App.-44
 External wiring 4-4

[F]
 Function version 2- 4, 8- 4

[G]
 G(P).OFFGAN..... App.-34
 G(P).OGLOAD App.-36
 G(P).OGSTOR App.-39

Gain setting request..... 3-17
 GX Configurator-TI 2- 3, 5-1
 GX Developer 2- 3

[H]
 Handling precautions 4- 1
 H/W information 8- 5

[I]
 I/O signals 3-13
 Ice bath..... 4-13
 Initial setting 5- 1, 5-13
 Input type selection function 3- 7
 Installation 5- 3
 Intelligent function module switch setting..... 4- 6

[M]
 Measured temperature value 3-28
 Micro voltage conversion function 3- 7
 Micro voltage conversion system 3- 8, 3- 11
 Micro voltage input/output conversion characteristic 3- 8
 Micro voltage value 3-28
 Module detail information 8- 4
 Module ready 3-14
 Monitoring/test..... 5-16

[O]
 Offset setting request..... 3-17
 Offset/gain setting 4- 8, 5-19, 5-21
 Offset/gain setting function 3- 7
 Offset/gain setting mode status flag 3-15
 Offset/gain setting status signal 3-14
 Offset/gain temperature value 3-36
 OMC refresh data 5-22
 Online module change..... 2- 2, 7- 1
 Operating condition setting completion signal 3-14
 Operating condition setting request 3-17
 Operating environment 5- 5

[P]
 Parameters..... 5- 7
 Part names and settings 4- 3
 Product information..... 2- 3

Product lineup.....	A- 10
Programming	6- 1
Pt100 cold junction temperature compensation yes/no specifying function.....	3- 7

[Q]

Q64TD	A- 10, 1- 1
Q64TDV-GH.....	A- 10, 1- 1
QCPU (Q mode).....	A- 10

[R]

Read from PLC.....	5-12
--------------------	------

[S]

Sampling processing.....	3- 9, 3-10
Scaling function	3- 7
Scaling range upper/lower limit value.....	3-33
Scaling value	3-33
Scaling width upper/lower limit value.....	3-34
Setting range	3-29
Setting range 1	3-30
Setting range 2	3-30
Setup and procedures before operation.....	4- 2
Status check	8- 4
Superheated operating limits	App.- 1
System monitor	8- 4

[T]

Temperature conversion function	3- 7
Temperature conversion system	3- 7, 3- 9, 3-10
Terminal block	4- 3
Text file	5- 8
Thermal electromotive force chart	App.- 2
Time/count averaging setting.....	3-26
Tolerances for temperatures.....	App.- 1
Troubleshooting.....	8- 1

[U]

User range write request	3-15
Usual operation limits	App.- 1
Utility package.....	5- 1

[W]

Warning output enable/disable setting.....	3-31
Warning output flag.....	3-31
Warning output function.....	3- 7
Warning output signal	3-15
Warning output upper/lower limit value.....	3-34
Wiring instructions.....	4- 4
Write to PLC.....	5-12

WARRANTY

Please confirm the following product warranty details before using this product.

1. Gratis Warranty Term and Gratis Warranty Range

If any faults or defects (hereinafter "Failure") found to be the responsibility of Mitsubishi occurs during use of the product within the gratis warranty term, the product shall be repaired at no cost via the sales representative or Mitsubishi Service Company.

However, if repairs are required onsite at domestic or overseas location, expenses to send an engineer will be solely at the customer's discretion. Mitsubishi shall not be held responsible for any re-commissioning, maintenance, or testing on-site that involves replacement of the failed module.

[Gratis Warranty Term]

The gratis warranty term of the product shall be for one year after the date of purchase or delivery to a designated place.

Note that after manufacture and shipment from Mitsubishi, the maximum distribution period shall be six (6) months, and the longest gratis warranty term after manufacturing shall be eighteen (18) months. The gratis warranty term of repair parts shall not exceed the gratis warranty term before repairs.

[Gratis Warranty Range]

- (1) The range shall be limited to normal use within the usage state, usage methods and usage environment, etc., which follow the conditions and precautions, etc., given in the instruction manual, user's manual and caution labels on the product.
- (2) Even within the gratis warranty term, repairs shall be charged for in the following cases.
 1. Failure occurring from inappropriate storage or handling, carelessness or negligence by the user. Failure caused by the user's hardware or software design.
 2. Failure caused by unapproved modifications, etc., to the product by the user.
 3. When the Mitsubishi product is assembled into a user's device, Failure that could have been avoided if functions or structures, judged as necessary in the legal safety measures the user's device is subject to or as necessary by industry standards, had been provided.
 4. Failure that could have been avoided if consumable parts (battery, backlight, fuse, etc.) designated in the instruction manual had been correctly serviced or replaced.
 5. Failure caused by external irresistible forces such as fires or abnormal voltages, and Failure caused by force majeure such as earthquakes, lightning, wind and water damage.
 6. Failure caused by reasons unpredictable by scientific technology standards at time of shipment from Mitsubishi.
 7. Any other failure found not to be the responsibility of Mitsubishi or that admitted not to be so by the user.

2. Onerous repair term after discontinuation of production

(1) Mitsubishi shall accept onerous product repairs for seven (7) years after production of the product is discontinued.

Discontinuation of production shall be notified with Mitsubishi Technical Bulletins, etc.

(2) Product supply (including repair parts) is not available after production is discontinued.

3. Overseas service

Overseas, repairs shall be accepted by Mitsubishi's local overseas FA Center. Note that the repair conditions at each FA Center may differ.

4. Exclusion of loss in opportunity and secondary loss from warranty liability

Regardless of the gratis warranty term, Mitsubishi shall not be liable for compensation of damages caused by any cause found not to be the responsibility of Mitsubishi, loss in opportunity, lost profits incurred to the user by Failures of Mitsubishi products, special damages and secondary damages whether foreseeable or not, compensation for accidents, and compensation for damages to products other than Mitsubishi products, replacement by the user, maintenance of on-site equipment, start-up test run and other tasks.

5. Changes in product specifications

The specifications given in the catalogs, manuals or technical documents are subject to change without prior notice.

6. Product application

- (1) In using the Mitsubishi MELSEC programmable controller, the usage conditions shall be that the application will not lead to a major accident even if any problem or fault should occur in the programmable controller device, and that backup and fail-safe functions are systematically provided outside of the device for any problem or fault.
- (2) The Mitsubishi programmable controller has been designed and manufactured for applications in general industries, etc. Thus, applications in which the public could be affected such as in nuclear power plants and other power plants operated by respective power companies, and applications in which a special quality assurance system is required, such as for Railway companies or Public service purposes shall be excluded from the programmable controller applications.

In addition, applications in which human life or property that could be greatly affected, such as in aircraft, medical applications, incineration and fuel devices, manned transportation, equipment for recreation and amusement, and safety devices, shall also be excluded from the programmable controller range of applications.

However, in certain cases, some applications may be possible, providing the user consults their local Mitsubishi representative outlining the special requirements of the project, and providing that all parties concerned agree to the special circumstances, solely at the users discretion.

Microsoft, Windows, Windows NT, and Windows Vista are registered trademarks of Microsoft Corporation in the United States and other countries.

Pentium and Celeron are trademarks of Intel Corporation in the United States and other countries.

Ethernet is a registered trademark of Xerox Corporation in the United States.

Other company names and product names used in this document are trademarks or registered trademarks of respective companies.

SPREAD

Copyright (c) 1996 FarPoint Technologies, Inc.

Thermocouple Input Module Channel Isolated Thermocouple/Micro Voltage Input Module

User's Manual

MODEL	Q64TD-U-S-E
MODEL CODE	13JR30
SH(NA)-080141-M(0805)MEE	



HEAD OFFICE : TOKYO BUILDING, 2-7-3 MARUNOUCHI, CHIYODA-KU, TOKYO 100-8310, JAPAN
NAGOYA WORKS : 1-14, YADA-MINAMI 5-CHOME, HIGASHI-KU, NAGOYA, JAPAN

When exported from Japan, this manual does not require application to the Ministry of Economy, Trade and Industry for service transaction permission.

Specifications subject to change without notice.